

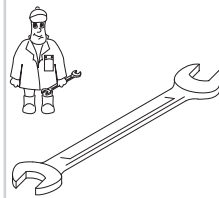

Gebr. Becker GmbH
Hölker Feld 29-31
D-42279 Wuppertal

Wartung
Maintenance
Entretien
Manutenzione
Mantenimiento



	Pos.	Menge ²⁾ Quantity Quantité Quantità Cantidad	Bestell-Nr. Ident No. No. Identification No. Identificazione No. de pedido	Bezeichnung Description Designation Designazione Descripción
VT 3.6/08	21	SATZ (KIT)	901303 00008	Schieber, Rotor Vane, Palette, Empujador
	24	1	909581 00000	Filterpatrone, Filter cartridge, Cartouche Filtrante, Cartuccia filtro, Cartucho de filtro

²⁾ erforderliche Bestellmenge / necessary order quantity / quantité nécessaire / quantità di ordinazione necessari / cantidad necesario



Ersatzteilliste
Spare parts list
Liste de pièces de rechange
Listino pezzi di ricambio
Lista de piezas de recambio
Lista de peças sobresselentes
Reserveonderdelenlijst
Reservedelsliste
Reservdelislista

Reservedelsliste
Varaosaluettelo
Wykaz części zamiennych
Seznam náhradních dílů
Tartalékalkatrész lista
Κατάλογος ανταλλακτικών
Перечень запасных частей
备用零件目录
スベアパーツリスト

VT 3.6/08



28000016102 02/2016

Index B

 SERVICE	 D-42279 Wuppertal www.becker-international.com	year <input type="text" value="XXXX"/> No. <input type="text" value="XXXXXXXXXXXX"/>	Index Option
	CE	type <input type="text" value="VT 3.6-XX"/> frequency <input type="text" value="XXXX"/> Hz speed <input type="text" value="XXXX"/> min ⁻¹ power required <input type="text" value="XXXX"/> kW inlet capacity <input type="text" value="XXXX"/> m ³ /h max. vacuum <input type="text" value="XXXX"/> mbar	

	Service: Tel: +49 (0)202 697-171 Fax: +49 (0)202 64 44 74 E-Mail: info@becker-international.com www.becker-international.com
--	---

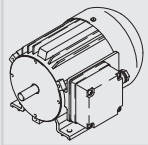

SERVICE ? i

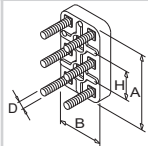
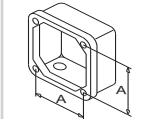
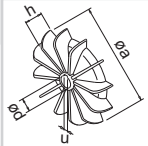

1~

C = ? μ F
U = ? V

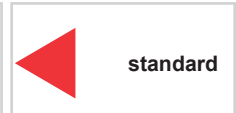
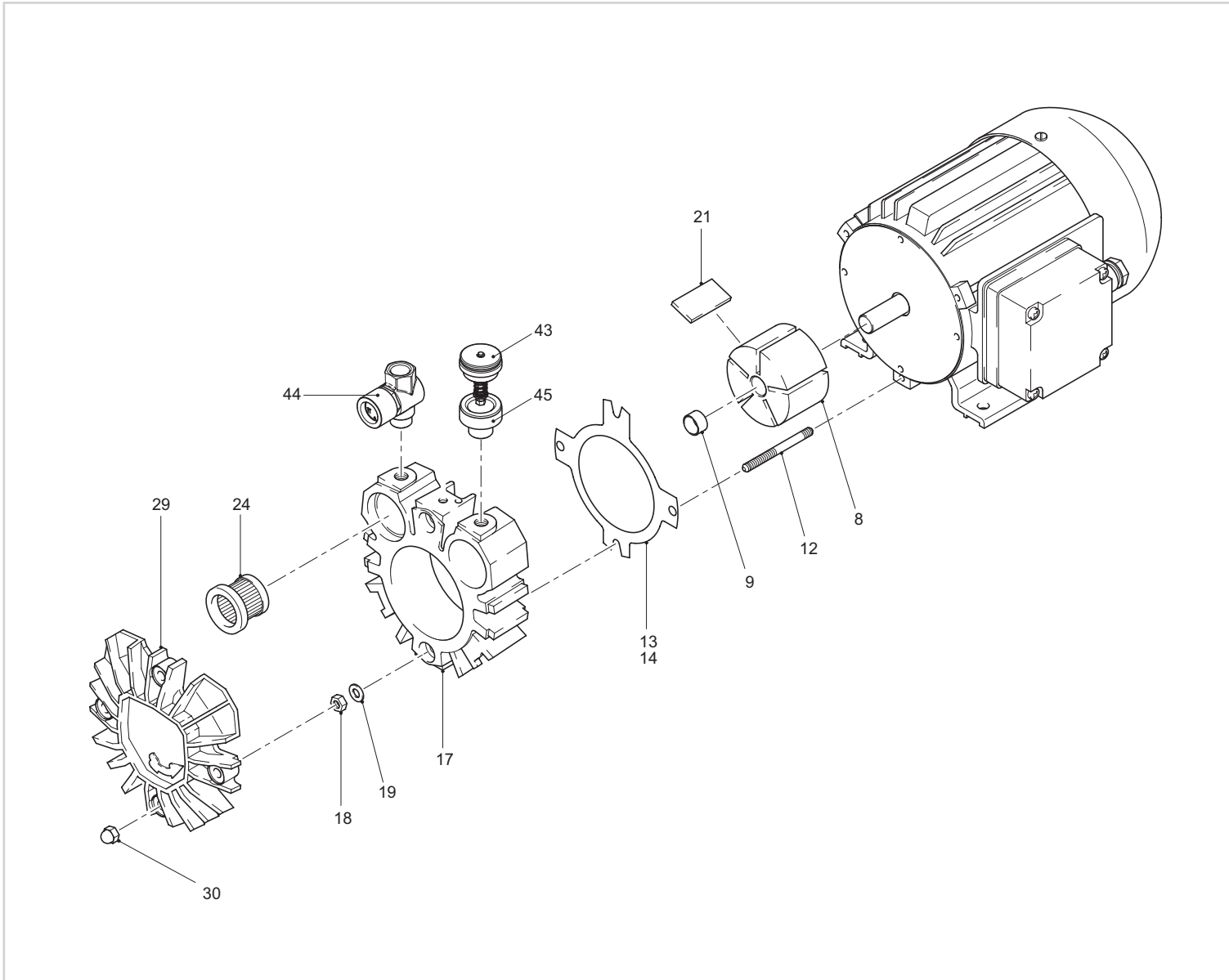
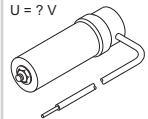

VT 3.6/08



VT 3.6/08

Pos.	Bestell Nr.	Beschreibung 	Description 	Designation 
8	020005 16100	KOLBEN	ROTOR	PISTON
9	911002 00000	STAR-TOLERANZRING	STAR-TOLERANCE-RING	BAGUE STAR
12	903804 00000	STIFTSCHRAUBE	STUD	GOUJON PRISONNIER
13	903233 00000	DICHTUNG	GASKET	JOINT
14	903232 00000	DICHTUNG	GASKET	JOINT
17	000102 16100	GEHÄUSE	PUMP BODY	CORP DE POMPE
18	947104 00000	SECHSKANTMUTTER	HEX.NUT	ECROU A 6PANS
19	951703 00000	FEDERSCHEIBE	LOCKING WASHER	RONDELLE À RESSORT
21	901303 00008	SCHIEBER-KOHLÉ (SATZ)	CARBON VANES (KIT)	PALETTE DE CHARBON (KIT)
24	909581 00000	FILTERPATRONE	FILTER CARTRIDGE	CARTOUCHE FILTRANTE
29	000705 16100	SEITENDECKEL	LID	COUVERCLE
30	947401 00000	HUTMUTTER	CAP NUT	ÉCROU BORGNE
43	727502 06000	ABBLASEVENTIL	BLOW-OFF VALVE	SILENCIEUX
44	736000 99618	VAKUUMREGULIERVENTIL	VACUUM REGULATING VALVE	SOUPAPE REGLAGE VIDE
45	921032 00000	GEWINDERING	THREADED RING	BAGUE FILETÉE



VT 3.6/08

Pos.	Bestell Nr.	Designazione 	Descripción 
8	020005 16100	ROTORE	ÉMBOLO
9	911002 00000	STAR-ANNELLO TOLLERANZA	ANILLO DE TOLERANCIA STAR
12	903804 00000	VITE PRIGIONIERA	ESPÁRRAGO
13	903233 00000	GUARNIZIONE	JUNTA
14	903232 00000	GUARNIZIONE	JUNTA
17	000102 16100	CARCASSA	CARCASA
18	947104 00000	DADO ESAGONALE	TUERCA HEXAGONAL
19	951703 00000	RONDELLA A MOLLA	ARANDELA DE RESORTE
21	901303 00008	PALETTE DI CHARBONE (KIT)	EMPUJADOR DE CARBÓN (KIT)
24	909581 00000	CARTUCCIA FILTRO	CARTUCHO DE FILTRO
29	000705 16100	COPERCHIO	TAPA LATERAL
30	947401 00000	DADO A CAPPELLO	TUERCA SOMBRERETE
43	727502 06000	SILENZIATORE	VÁLVULA DE BARRIDO
44	736000 99618	VALVOLA REGOLAZIONE VUOTO	VÁLVULA REGULADORA DE VACÍO
45	921032 00000	ANELLO FILETTATO	ANILLO ROSCADO