

DTLF / VTLF 200
DTLF / VTLF 250
DTLF / VTLF 360
DVTLF 250

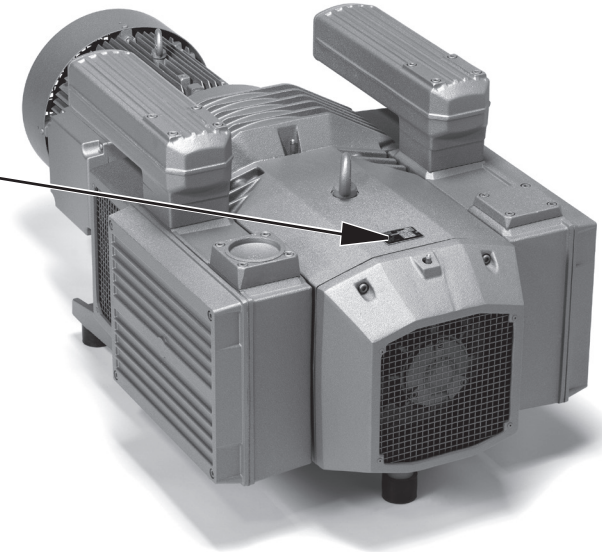
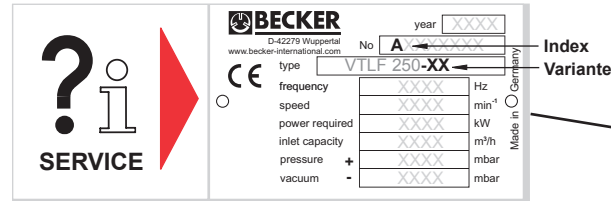
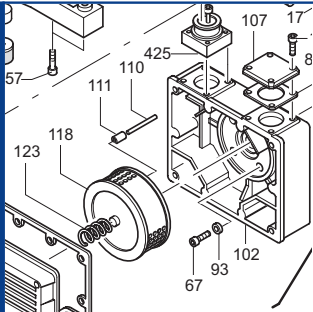

Ersatzteilliste
Spare parts list
Liste de pièces de rechange
Listino pezzi di ricambio
Lista de piezas de recambio
Lista de peças sobresselentes
Reserveonderdelenlijst
Atsarginių dalių sąrašas
Varuosad nimekirja
Rezerves daļu saraksts

Reservedelsliste
Reservdelslista
Varaosuettelotelo
Reservedelsliste
Wykaz części zamiennych
Tartalékalkatrész lista
Seznam náhradních dílů
Seznam nadomestnih delov
Zoznam náhradných dielov
Rezervni dijelovi popis

Lista pieselor de schimb
Páirteanna spártha liosta
Κατάλογος ανταλλακτικών
Yedek parça listesi
Списък на резервните части
Перечень запасных частей
スペアパーツリスト
예비 부품 목록
备用零件目录



Sales and service network

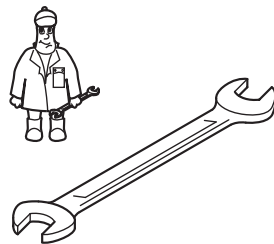

Wartung
Maintenance
Entretien
Manutenzione
Mantenimiento



Pos.	Menge ²⁾ Quantity Quantité Quantità Cantidad	Bestell-Nr. Ident No. No. Identification No. Identificazione No. de pedido	Bezeichnung Description Designation Designazione Descripción
□	1	549000 22200	Dichtungssatz, Complete set of seals, Jeu de joints, Kit di guarnizioni, Junta completa
7 7	SATZ/KIT	901367 01005 901318 00005	Schieber, Rotor Vane, Palette, Empujador " VTLF 200/9 + VTLF 250/9
118	1	909534 00000	Filterpatrone, Filter cartridge, Cartouche Filtrante, Cartuccia filtro, Cartucho de filtro
118 118	1 1	909559 00000 909541 00000	" TLF 250/0-72 " TLF 200/6-73 + TLF 250/6-73
507	2 ³⁾	909510 00000	Filterpatrone, Filter cartridge, Cartouche Filtrante, Cartuccia filtro, Cartucho de filtro
518	1 ³⁾	909541 00000	Filterpatrone, Filter cartridge, Cartouche Filtrante, Cartuccia filtro, Cartucho de filtro

²⁾ erforderliche Bestellmenge / necessary order quantity / quantité nécessaire / quantità di ordinazione necessari / cantidad necesario

³⁾ variantenabhängig / variant-dependent / variante-dependantes / variante-dispendenti / variante-dependientes

()TLF 200
 ()TLF 250
 ()TLF 360

Standard



Variante

 ①
 VTLF 250 SK
 DTLF 250 SK
 DVTLF 250 SK

 ②
 DVTLF 250 KSK

 ③
 DTLF/0-44

 ④
 DTLF 250/0-72
 VTLF 250/0-72
 DVTLF 250/0-72

 ⑤
 DTLF 250/6
 VTLF 250/6

 ⑥
 DTLF 250/6-73
 VTLF 250/6-73

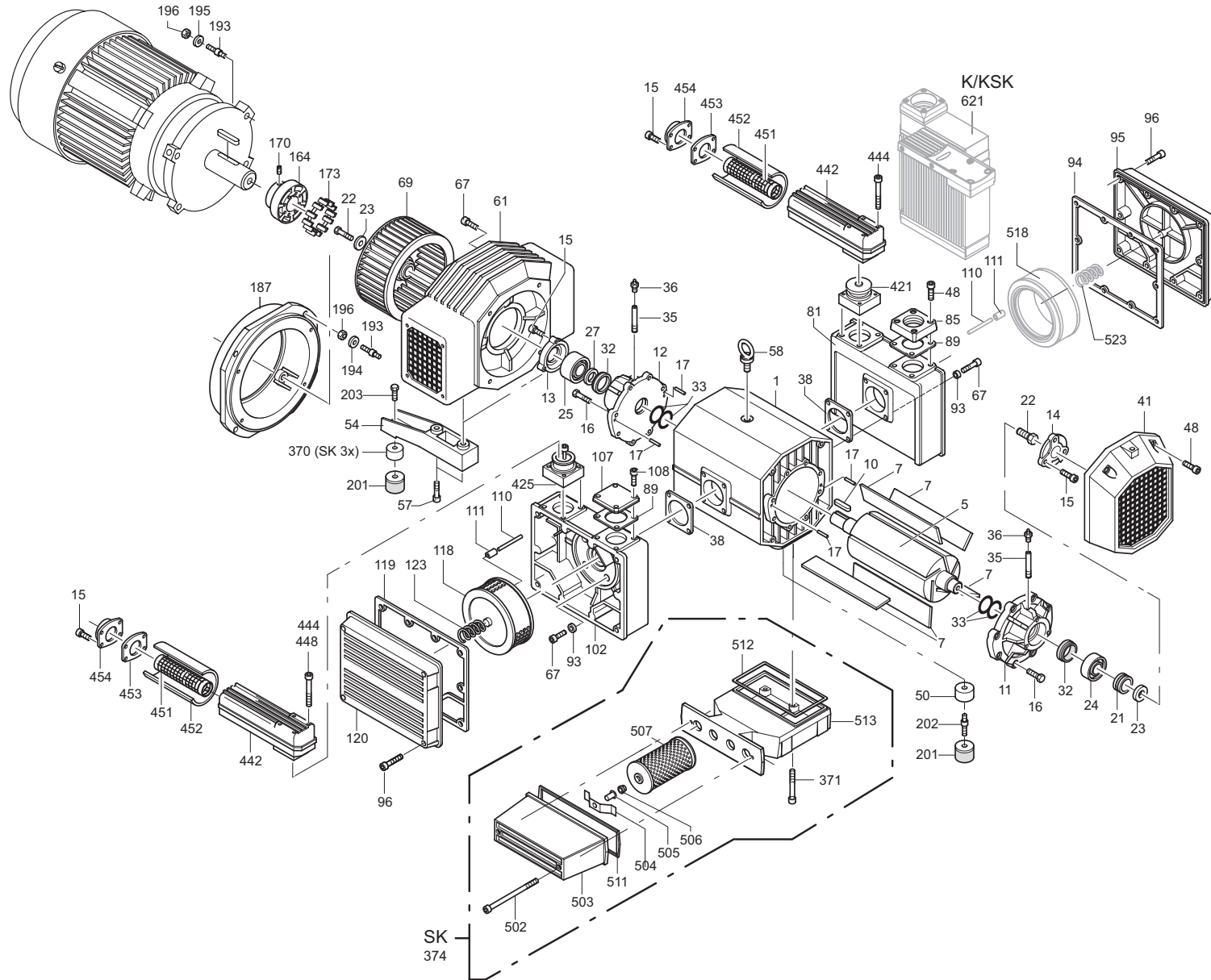
 ⑦
 DTLF 250/9
 VTLF 250/9

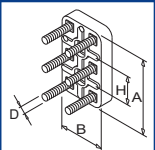
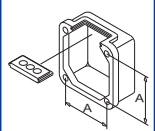
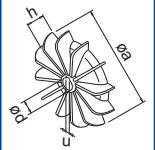
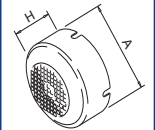
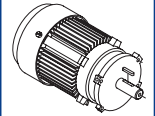

SERVICE ?



A INDEX	Pos.	Bestell Nr.	Beschreibung	DE
()TLF 200-360	□	549000 22200	DICHTUNGSSATZ ¹⁾	
	◆	570300 22200	UMBAUSATZ *TLF 250* ➔ *TLF 250/0-72 ²⁾	
	1	000100 22200	GEHÄUSE	
	5	020000 22200	KOLBEN	
	7	901367 01005	KOHLESCHIEBER (SATZ)	
	10	947812 00000	PASSFEDER	
	11	000700 22200	SEITENDECKEL	
	12	000800 22200	SEITENDECKEL	
	13	001100 22200	LAGERDECKEL	
	14	001000 22200	LAGERDECKEL	
	15	945320 00000	INNENSECHSKANTSCHRAUBE	
	16	945230 00000	SECHSKANTSCHRAUBE	
	17	948742 00000	PASSKERBSTIFT	
	21	068900 91000	FETT-TRANSPORTRING	
	22	945270 00000	WELLENENDSCHRAUBE	
	23	949409 00000	UNTERLEGSCHEIBE	
	24	906649 00000	WÄLZLAGER NU 207/C3	
	25	906617 20000	WÄLZLAGER 3307-E-C3	
27	511400 22200	DISTANZSCHEIBENSATZ		
32	906577 00000	WELLENDICHTRING		
33	911310 00000	DICHTUNGSSCHLAUCH		
35	908100 22200	FETTDRUCKROHR		
36	949001 00000	SCHMIERNIPPEL		
38	003100 22200	DICHTUNG		
41	520800 22200	LUFTLEITHAUBE, KOMPL.		
48	945333 00000	INNENSECHSKANTSCHRAUBE		
50	011400 22200	DISTANZSCHEIBE		
54	015100 22200	FUSS		
57	945353 00000	INNENSECHSKANTSCHRAUBE		
58	948804 00000	RINGSCHRAUBE		
61	560200 22200	LATERNE, KOMPL.		
67	945350 00000	INNENSECHSKANTSCHRAUBE		
69	544503 22200	KUPPLUNGSHÄLFTE MIT VENTILATOR		
81	040105 22200	FILTERGEHÄUSE		
85	007800 52200	ANSCHLUSSFLANSCH		
89	007900 22200	DICHTUNG		
93	951710 00000	FEDERSCHEIBE		
94	003000 22200	DICHTUNG		
95	040206 22200	FILTERDECKEL		
96	945336 00000	INNENSECHSKANTSCHRAUBE		
102	040106 22200	FILTERGEHÄUSE		
107	005600 22200	VERSCHLUSSPLATTE		
108	945330 00000	INNENSECHSKANTSCHRAUBE		
110	952006 00000	SPANNHÜLSE		
111	042600 10100	SCHLAUCH		
118	909534 00000	FILTERPATRONE C22115 (1x) ³⁾		
119	008900 22200	DICHTUNG		
120	040207 22200	FILTERDECKEL		
123	828600 99216	FEDER		
164	902100 22200	MOTORKUPPLUNG, Ø 38MM		
164	902101 22200	MOTORKUPPLUNG, Ø 42MM		
164	902102 22200	MOTORKUPPLUNG, Ø 48MM		
164	902103 22200	MOTORKUPPLUNG, Ø 1 5/8"		
164	902104 22200	MOTORKUPPLUNG, Ø 1 7/8"		
170	946107 00000	GEWINDESTIFT		
173	902200 20000	KUPPLUNGSRING		
187	500900 22200	MOTORFLANSCH, B5/300		
187	500901 22200	MOTORFLANSCH, B5/350		
187	500902 22200	MOTORFLANSCH, 10HP		

A INDEX	Pos.	Bestell Nr.	Beschreibung	DE
	187	500903 22200	MOTORFLANSCH, 15/20HP	
	193	946945 00000	STIFTSCHRAUBE	
	194	947507 00000	UNTERLEGSCHEIBE	
	195	949455 00000	UNTERLEGSCHEIBE	
	196	947107 00000	SECHSKANTMUTTER	
	201	741303 00000	GUMMI-PUFFER	
	202	951022 00000	STIFTSCHRAUBE	
	203	945348 00000	INNENSECKSKANTSCHRAUBE	
	421	534001 99619	DRUCKSICHERHEITSVENTIL, 0.4-0.8 BAR	
	421	534002 99619	DRUCKSICHERHEITSVENTIL, 0.75-1.5 BAR	
	421	534003 99619	DRUCKSICHERHEITSVENTIL, 1.5-2.0 BAR	
	421	534000 99619	ABBLASEVENTIL, 0.13 BAR	
	425	535001 99619	VAKUUMSICHERHEITSVENTIL, 0.6-0.2 BAR (ABS.)	
	442	007400 99619	SCHALLDÄMPFERGEHÄUSE	
	444	945347 00000	INNENSECKSKANTSCHRAUBE, M8X150	
	448	945345 00000	INNENSECKSKANTSCHRAUBE, M8X110	
	451	007600 92000	SIEBROHR	
	452	907700 70000	DÄMPFER-MINERALWOLLE	
	453	607500 83000	DICHTUNG	
	454	007801 83000	FLANSCH	
	518	909541 00000	STAUBABSCHIEDER C2263/3 - OPTIONAL	
	523	934317 00000	FEDER - OPTIONAL	
		743303 00000	SPEZIALFETT (FETTPRESSE, 50g)	
¹⁾ Dichtungssatz - 54900022200 - Pos.: 33, 38, 89, 94, 119 ²⁾ Umbausatz ➔/0-72 - 57030022200 - Pos.: 118, 119, 120, 121, 122 ³⁾ erforderliche Bestellmenge / Wartung				

A INDEX	Pos.	Ident No.	Description	
()TLF 200-360	□	549000 22200	GASKET SET ¹⁾	
	◆	570300 22200	CONVERSION SET *TLF 250* ➔ *TLF 250/0-72 ²⁾	
	1	000100 22200	PUMP BODY	
	5	020000 22200	ROTOR	
	7	901367 01005	ROTOR VANES (KIT)	
	10	947812 00000	KEY	
	11	000700 22200	LID	
	12	000800 22200	LID	
	13	001100 22200	BEARING COVER	
	14	001000 22200	BEARING COVER	
	15	945320 00000	SOCKET HEAD SCREW	
	16	945230 00000	HEX-HEAD SCREW	
	17	948742 00000	STRAIGHT PIN	
	21	068900 91000	GREASE DISTRIBUTION WASHER	
	22	945270 00000	SHAFT END BOLD	
	23	949409 00000	WASHER	
	24	906649 00000	BALL BEARING NU 207/C3	
	25	906617 20000	BALL BEARING 3307-E-C3	
	27	511400 22200	SPACER SET	
	32	906577 00000	SHAFT-SEALING RING	
	33	911310 00000	SEAL	
	35	908100 22200	CONDUIT-GREASE	
	36	949001 00000	GREASE NIPPLE	
	38	003100 22200	GASKET	
	41	520800 22200	PROTECTIVE HOOD	
	48	945333 00000	SOCKET HEAD SCREW	
	50	011400 22200	DISTANCE-DISC	
	54	015100 22200	FOOT	
	57	945353 00000	SOCKET HEAD SCREW	
	58	948804 00000	RING SCREW	
	61	560200 22200	CONNECTION FLANGE	
	67	945350 00000	SOCKET HEAD SCREW	
	69	544503 22200	COUPLING WITH FAN	
	81	040105 22200	FILTER HOUSING	
	85	007800 52200	CONNECTING FLANGE	
	89	007900 22200	GASKET	
	93	951710 00000	SPRING DISC	
	94	003000 22200	GASKET	
	95	040206 22200	FILTER COVER	
	96	945336 00000	SOCKET HEAD SCREW	
	102	040106 22200	FILTER HOUSING	
	107	005600 22200	COVER	
	108	945330 00000	SOCKET HEAD SCREW	
	110	952006 00000	LOCATING PEG	
	111	042600 10100	TUBE FLEXIBLE	
	118	909534 00000	FILTER CARTRIDGE C22115 (1x) ³⁾	
	119	008900 22200	GASKET	
	120	040207 22200	FILTER COVER	
	123	828600 99216	SPRING	
	164	902100 22200	COUPLING MOTOR SIDE, Ø38MM	
	164	902101 22200	COUPLING MOTOR SIDE, Ø42MM	
	164	902102 22200	COUPLING MOTOR SIDE, Ø48MM	
	164	902103 22200	COUPLING MOTOR SIDE, Ø 1 5/8"	
	164	902104 22200	COUPLING MOTOR SIDE, Ø 1 7/8"	
	170	946107 00000	THREADED PIN	
	173	902200 20000	COUPLING RING	
	187	500900 22200	MOTOR FLANGE, B5/300	
	187	500901 22200	MOTOR FLANGE, B5/350	
	187	500902 22200	MOTOR FLANGE, 10HP	

A INDEX	Pos.	Ident No.	Description	
	187	500903 22200	MOTOR FLANGE, 15/20HP	
	193	946945 00000	STUD	
	194	947507 00000	WASHER	
	195	949455 00000	WASHER	
	196	947107 00000	HEX. NUT	
	201	741303 00000	RUBBER BUFFER	
	202	951022 00000	STUD	
	203	945348 00000	SOCKET HEAD SCREW	
	421	534001 99619	PRESSURE RELIEVE VALVE, 0.4-0.8 BAR	
	421	534002 99619	PRESSURE RELIEVE VALVE, 0.75-1.5 BAR	
	421	534003 99619	PRESSURE RELIEVE VALVE, 1.5-2.0 BAR	
	421	534000 99619	BLOW-OFF VALVE, 0.13 BAR	
	425	535001 99619	VACUUM RELIEF VALVE, 0.6-0.2 BAR (ABS.)	
	442	007400 99619	SILENCER HOUSING	
	444	945347 00000	SOCKET HEAD SCREW, M8X150	
	448	945345 00000	SOCKET HEAD SCREW, M8X110	
	451	007600 92000	STRAINER TUBE	
	452	907700 70000	SILENCER-MATERIAL	
	453	607500 83000	GASKET	
	454	007801 83000	CONNECTING FLANGE	
	518	909541 00000	DUST SEPARATOR C2263/3 - OPTIONAL	
	523	934317 00000	SPRING - OPTIONAL	
		743303 00000	SPECIAL GREASE (GREASE PRESS, 50g)	
¹⁾ Set of seals - 54900022200 - Pos.: 33, 38, 89, 94, 119 ²⁾ Conversion set ➔/0-72 - 57030022200 - Pos.: 118, 119, 120, 121, 122 ³⁾ necessary order quantity / maintenance				

A INDICE	Pos.	No. Identification	Designation	FR	
()TLF 200-360	□	549000 22200	JEU DE JOINTS ¹⁾		
	◆	570300 22200	ÉQUIPEMENT DE CONVERSION		
			TLF 250 ➔ *TLF 250/0-72 ²⁾		
	1	000100 22200	CORP DE POMPE		
	5	020000 22200	PISTON		
	7	901367 01005	PALETTE DE CHARBON (KIT)		
	10	947812 00000	CLAVETTE		
	11	000700 22200	COUVERCLE		
	12	000800 22200	COUVERCLE		
	13	001100 22200	COUVERCLE DE ROULEMENT		
	14	001000 22200	COUVERCLE DE ROULEMENT		
	15	945320 00000	VIS HEXAGONALE INTERNE		
	16	945230 00000	VIS HEXAGONALE		
	17	948742 00000	GOUPILLE CYLINDRIQUE		
	21	068900 91000	BAGUE DE TRANSPORT DE GRAISSE		
	22	945270 00000	VIS BOUT D'ARBRE		
	23	949409 00000	RONDELLE		
	24	906649 00000	ROULEMENT A BILLES NU 207/C3		
	25	906617 20000	ROULEMENT A BILLES 3307-E-C3		
	27	511400 22200	JEU DE DISQUES DE TOLERANCE		
	32	906577 00000	BAGUE D'ETANCHEITE		
	33	911310 00000	JOINT		
	35	908100 22200	TUYEAU DE GRAISSAGE		
	36	949001 00000	GRAISSEUR		
	38	003100 22200	JOINT		
	41	520800 22200	CARTER PROTECTEUR		
	48	945333 00000	VIS HEXAGONALE INTERNE		
	50	011400 22200	DISQUE AJUSTAGE		
	54	015100 22200	PIED		
	57	945353 00000	VIS HEXAGONALE INTERNE		
	58	948804 00000	PITON		
	61	560200 22200	BRIDE DE RACCORDEMENT		
	67	945350 00000	VIS HEXAGONALE INTERNE		
	69	544503 22200	ACCOUPLLEMENT AVEC VENTILATEUR		
	81	040105 22200	BOITE POUR FILTRE		
	85	007800 52200	BRIDE DE RACCORDEMENT		
	89	007900 22200	JOINT		
	93	951710 00000	DISQUE DE RESSORT		
	94	003000 22200	JOINT		
	95	040206 22200	COUVERCLE DU FILTRE		
	96	945336 00000	VIS HEXAGONALE INTERNE		
	102	040106 22200	BOITE POUR FILTRE		
	107	005600 22200	COUVERCLE DE FERMETURE		
	108	945330 00000	VIS HEXAGONALE INTERNE		
	110	952006 00000	DOVILLE DE ETRAGE		
	111	042600 10100	TUBE FLEXIBLE		
	118	909534 00000	CARTOUCHE FILTRANTE C22115 (1x) ³⁾		
	119	008900 22200	JOINT		
	120	040207 22200	COUVERCLE DU FILTRE		
	123	828600 99216	RESSORT		
	164	902100 22200	ACCOUPLLEMENT MOTEUR, Ø38MM		
	164	902101 22200	ACCOUPLLEMENT MOTEUR, Ø42MM		
	164	902102 22200	ACCOUPLLEMENT MOTEUR, Ø48MM		
	164	902103 22200	ACCOUPLLEMENT MOTEUR, Ø 1 5/8"		
	164	902104 22200	ACCOUPLLEMENT MOTEUR, Ø 1 7/8"		
	170	946107 00000	GOUPILLE FILETEE		
	173	902200 20000	ANNEAU D'ACCOUPLLEMENT		
	187	500900 22200	BRIDE MOTEUR, B5/300		
	187	500901 22200	BRIDE MOTEUR, B5/350		
	187	500902 22200	BRIDE MOTEUR, 10HP		

A INDICE	Pos.	No. Identification	Designation	FR	
	187	500903 22200	BRIDE MOTEUR, 15/20HP		
	193	946945 00000	PRISONNIER		
	194	947507 00000	RONDELLE		
	195	949455 00000	RONDELLE		
	196	947107 00000	ECROU A 6 PANS		
	201	741303 00000	AMORTISSEUR EN CAOUTCHOUC		
	202	951022 00000	PRISONNIER		
	203	945348 00000	VIS HEXAGONALE INTERNE		
	421	534001 99619	SOUPAPE DE SURERE PRESSION, 0.4-0.8 BAR		
	421	534002 99619	SOUPAPE DE SURERE PRESSION, 0.75-1.5 BAR		
	421	534003 99619	SOUPAPE DE SURERE PRESSION, 1.5-2.0 BAR		
	421	534000 99619	SILENCIEUX, 0.13 BAR		
	425	535001 99619	SOUPAPE DE SURETE VIDE, 0.6-0.2 BAR (ABS.)		
	442	007400 99619	CARCASSE SILENCIEUX		
	444	945347 00000	VIS HEXAGONALE INTERNE, M8X150		
	448	945345 00000	VIS HEXAGONALE INTERNE, M8X110		
	451	007600 92000	GRILLE POUR SILENCIEUX		
	452	907700 70000	MATERIAL POUR SILENCIEUX		
	453	607500 83000	JOINT		
	454	007801 83000	BRIDE DE RACCORDEMENT		
	518	909541 00000	SÉPARATEUR DE LA POUSSIÈRE - EN OPTION		
	523	934317 00000	RESSORT - EN OPTION		
		743303 00000	GRAISSE SPÉCIFIQUE (POMPE À GRAISSE, 50g)		



¹⁾ Jeu de joints - 54900022200 - Pos.: 33, 38, 89, 94, 119
²⁾ Équipement de conversion ➔ 0-72 - 57030022200 - Pos.: 118, 119, 120, 121, 122
³⁾ quantité nécessaire / entretien

A INDICE	Pos.	No. Identificazione	Designazione	IT	
()TLF 200-360	□	549000 22200	KIT GUARNIZIONI ¹⁾		
	◆	570300 22200	ATTREZZATURA PER LA TRASFORMAZIONE		
			TLF 250 ➔ *TLF 250/0-72 ²⁾		
	1	000100 22200	CARCASSA		
	5	020000 22200	ROTORE		
	7	901367 01005	PALETTE (KIT)		
	10	947812 00000	CHIAVETTA		
	11	000700 22200	COPERCHIO		
	12	000800 22200	COPERCHIO		
	13	001100 22200	COPERCHIO CUSCINETTO		
	14	001000 22200	COPERCHIO CUSCINETTO		
	15	945320 00000	VITE ESAGONALE INTERNA		
	16	945230 00000	VITE ESAGONALE		
	17	948742 00000	PERNO		
	21	068900 91000	ANELLO INGRASSAGGIO		
	22	945270 00000	VITE DI CHIUSURA ALBERO		
	23	949409 00000	RONDELLA		
	24	906649 00000	CUSCINETTO A SFERA NU 207/C3		
	25	906617 20000	CUSCINETTO A SFERA 3307-E-C3		
	27	511400 22200	SERIE DI DISCO A DISTANZA		
	32	906577 00000	GUARNIZIONE PER L'ALBERO		
	33	911310 00000	GUARNIZIONE		
	35	908100 22200	TUBETTO D'INGRASSAGGIO		
	36	949001 00000	RACCORDO DI LUBRIFICAZIONE		
	38	003100 22200	GUARNIZIONE		
	41	520800 22200	CARTER DI PROTEZIONE		
	48	945333 00000	VITE ESAGONALE INTERNA		
	50	011400 22200	DISCO DISTANZA		
	54	015100 22200	PIEDE		
	57	945353 00000	VITE ESAGONALE INTERNA		
	58	948804 00000	GANCIO		
	61	560200 22200	FLANGIA DI RACCORDE		
	67	945350 00000	VITE ESAGONALE INTERNA		
	69	544503 22200	GIUNTO CON VENTILATORE		
	81	040105 22200	CONTENITORE FILTRO		
	85	007800 52200	FLANGIA DI RACCORDO		
	89	007900 22200	GUARNIZIONE		
	93	951710 00000	DISCO A MOLLA		
	94	003000 22200	GUARNIZIONE		
	95	040206 22200	COPERCHIO FILTRO		
	96	945336 00000	VITE ESAGONALE INTERNA		
	102	040106 22200	CONTENITORE FILTRO		
	107	005600 22200	COPERCHIO		
	108	945330 00000	VITE ESAGONALE INTERNA		
	110	952006 00000	SPINE DI RISCONTRO		
	111	042600 10100	TUBO FLESSIBILE		
	118	909534 00000	CARTUCCIA FILTRO C22115 (1x) ³⁾		
	119	008900 22200	GUARNIZIONI		
	120	040207 22200	COPERCHIO FILTRO		
	123	828600 99216	MOLLA		
	164	902100 22200	GIUNTO MOTORE		
	164	902101 22200	GIUNTO MOTORE, Ø 42MM		
	164	902102 22200	GIUNTO MOTORE, Ø 48MM		
	164	902103 22200	GIUNTO MOTORE, Ø 1 5/8"		
	164	902104 22200	GIUNTO MOTORE, Ø 1 7/8"		
	170	946107 00000	SPINA FILETTATA		
	173	902200 20000	ANELLO GIUNTO		
	187	500900 22200	FLANGIA MOTORE, B5/300		
	187	500901 22200	FLANGIA MOTORE, B5/350		
	187	500902 22200	FLANGIA MOTORE, 10HP		

A INDICE	Pos.	No. Identificazione	Designazione	IT	
	187	500903 22200	FLANGIA MOTORE, 15/20HP		
	193	946945 00000	L'ASTA A VITE		
	194	947507 00000	RONDELLA		
	195	949455 00000	RONDELLA		
	196	947107 00000	DADO ESAGONALE		
	201	741303 00000	AMMORTIZZATORE IN GOMMA		
	202	951022 00000	L'ASTA A VITE		
	203	945348 00000	VITE ESAGONALE INTERNA		
	421	534001 99619	VALVOLA SICUREZZA PRESSIONE, 0.4-0.8 BAR		
	421	534002 99619	VALVOLA SICUREZZA PRESSIONE, 0.75-1.5 BAR		
	421	534003 99619	VALVOLA SICUREZZA PRESSIONE, 1.5-2.0 BAR		
	421	534000 99619	SILENZIATORE, 0.13 BAR		
	425	535001 99619	VALVOLA SICUREZZA VUOTO, 0.6-0.2 BAR (ABS.)		
	442	007400 99619	CARCASSA SILENZIATORE		
	444	945347 00000	VITE ESAGONALE INTERNA, M8X150		
	448	945345 00000	VITE ESAGONALE INTERNA, M8X110		
	451	007600 92000	TUBO-CRIVELLO		
	452	907700 70000	MATERIALE PER SILENZIATORE		
	453	607500 83000	GUARNIZIONE		
	454	007801 83000	FLANGIA DI RACCORDO		
	518	909541 00000	SEPARATORE DELLE POLVERI - OPTIONALE		
	523	934317 00000	MOLLA - OPTIONALE		
		743303 00000	GRASSO SPECIALE (INGRASSATORE A PISTOLA, 50g)		

¹⁾ Serie di guarnizione - 54900022200 - Pos.: 33, 38, 89, 94, 119
²⁾ Attrezzatura per la trasformazione ➔ 0-72 - 57030022200 - Pos.: 118, 119, 120, 121, 122
³⁾ quantità di ordinazione necessari / manutenzione



A INDICE	Pos.	No. De pedido	Descripción	ES	
					
()TLF 200-360	□	549000 22200	JUEGO DE JUNTA ¹⁾		
	◆	570300 22200	EQUIPO PARA LA CONVERSIÓN *TLF 250* → *TLF 250/0-72 ²⁾		
	1	000100 22200	CARCASA		
	5	020000 22200	ÉMBOLO		
	7	901367 01005	DESPLAZADOR DE CARBÓN (KIT)		
	10	947812 00000	LENGÜETA DE AJUSTE		
	11	000700 22200	TAPA LATERAL		
	12	000800 22200	TAPA LATERAL		
	13	001100 22200	TAPA DE COJINETE		
	14	001000 22200	TAPA DE COJINETE		
15	945320 00000	TORNILLO HEXAGONAL INTERIOR			
16	945230 00000	TORNILLO DE CABEZA HEXAGONAL			
17	948742 00000	PASADOR ENTALLADO DE AJUSTE			
21	068900 91000	ANILLO DE TRANSPORTE DE GRASA			
22	945270 00000	TORNILLO TERMINAL DE ÁRBOL			
23	949409 00000	ARANDELA			
24	906649 00000	COJINETE DE RODAMIENTO NU 207/C3			
25	906617 20000	COJINETE DE RODAMIENTO 3307-E-C3			
27	511400 22200	JUEGO DE ARANDELAS DE AJUSTE			
32	906577 00000	ANILLO DE JUNTA DE ÁRBOL			
33	911310 00000	MANGUERA DE JUNTA			
35	908100 22200	TUBO DE PRESIÓN DE GRASA			
36	949001 00000	BOQUILLA DE LUBRICACIÓN			
38	003100 22200	JUNTA			
41	520800 22200	CAPERUZA CONDUCTORA DE AIRE COMPLETA.			
48	945333 00000	TORNILLO HEXAGONAL INTERIOR			
50	011400 22200	ARANDELA DISTANCIADORA			
54	015100 22200	PIE			
57	945353 00000	TORNILLO HEXAGONAL INTERIOR			
58	948804 00000	TORNILLO DE CÁNCAMO			
61	560200 22200	FAROL COMPLETO.			
67	945350 00000	TORNILLO HEXAGONAL INTERIOR			
69	544503 22200	MITAD DE ACOPLAMIENTO CON VENTILADOR			
81	040105 22200	CARCASA DE FILTRO			
85	007800 52200	BRIDA DE EMPALME			
89	007900 22200	JUNTA			
93	951710 00000	ARANDELA ELÁSTICA			
94	003000 22200	JUNTA			
95	040206 22200	TAPA DE FILTRO			
96	945336 00000	TORNILLO HEXAGONAL INTERIOR			
102	040106 22200	CARCASA DE FILTRO			
107	005600 22200	PLACA DE CIERRE			
108	945330 00000	TORNILLO HEXAGONAL INTERIOR			
110	952006 00000	CASQUILLO TENSOR			
111	042600 10100	MANGUERA			
118	909534 00000	CARTUCHO DE FILTRO C22115 (1x) ³⁾			
119	008900 22200	JUNTA DE GOMA			
120	040207 22200	TAPA DE FILTRO			
123	828600 99216	MUELLE			
164	902100 22200	ACOPAMIENTO DE MOTOR, Ø38MM			
164	902101 22200	ACOPAMIENTO DE MOTOR, Ø42MM			
164	902102 22200	ACOPAMIENTO DE MOTOR, Ø48MM			
164	902103 22200	ACOPAMIENTO DE MOTOR, Ø 1 5/8"			
164	902104 22200	ACOPAMIENTO DE MOTOR, Ø 1 7/8"			
170	946107 00000	VARILLA ROSCADA			
173	902200 20000	ANILLO DE ACOPLAMIENTO			
187	500900 22200	BRIDA DE MOTOR, B5/300			
187	500901 22200	BRIDA DE MOTOR, B5/350			
187	500902 22200	BRIDA DE MOTOR, 10HP			

A INDICE	Pos.	No. De pedido	Descripción	ES	
					
	187	500903 22200	BRIDA DE MOTOR, 15/20HP		
	193	946945 00000	ESPÁRRAGO		
	194	947507 00000	ARANDELA		
	195	949455 00000	ARANDELA		
	196	947107 00000	TUERCA HEXAGONAL		
	201	741303 00000	AMORTIGUADOR DE GOMA		
	202	951022 00000	ESPÁRRAGO		
	203	945348 00000	TORNILLO DE CABEZA INTERIOR HEXAGONAL		
	421	534001 99619	VÁLVULA DE SEGURIDAD DE PRESIÓN, 0.4-0.8 BAR		
	421	534002 99619	VÁLVULA DE SEGURIDAD DE PRESIÓN, 0.75-1.5 BAR		
	421	534003 99619	VÁLVULA DE SEGURIDAD DE PRESIÓN, 1.5-2.0 BAR		
	421	534000 99619	VÁLVULA DE BARRIDO, 0.13 BAR		
	425	535001 99619	VÁLVULA ASEGURADORA DE VACÍO, 0.6-0.2 BAR (ABS.)		
	442	007400 99619	CARCASA DE SILENCIADOR		
	444	945347 00000	TORNILLO HEXAGONAL INTERIOR, M8X150		
	448	945345 00000	TORNILLO HEXAGONAL INTERIOR, M8X110		
	451	007600 92000	TUBO DE CRIBA		
	452	907700 70000	LANA MINERAL DE AMORTIGUADOR		
	453	607500 83000	JUNTA		
	454	007801 83000	BRIDA DE EMPALME		
	518	909541 00000	SEPARADOR DE POLVO - OPCIONAL		
	523	934317 00000	MUELLE - OPCIONAL		
		743303 00000	GRASA ESPECIAL (PISTOLA DE GRASA, 50g)		

¹⁾ Junta completa - 54900022200 - Pos.: 33, 38, 89, 94, 119
²⁾ Equipo para la conversión → 0-72 - 57030022200 - Pos.: 118, 119, 120, 121, 122
³⁾ cantidad necesario / mantenimiento

()TLF 200 ()TLF 250 ()TLF 360	Variante 	Pos. ²⁾	Bestell Nr. / Ident No. / No. Identification / No. Identificazione / No. De pedido		Beschreibung / Description / Designation / Designazione / Desripcion
① VTLF 250 SK VTLF 360 SK DVTLF 250 SK - mit Spülkühler - with special cooler - avec refroidisseur spécial - con radiatore speciale - con refrigerador especial		1	000101 22200	000100-22200	GEHÄUSE / PUMP BODY / CORP DE POMPE / CARCASSA / CARCASA
		50	011401 22200	011400-22200	DISTANZSCHEIBE / DISTANCE-DISK / DISQUE AJUSTAGE / DISCO DISTANZA / ARANDELA DISTANCIADORA
		202	951035 00000	954022-00000	STIFTSCHRAUBE / STUD / PRISONNIER / L'ASTA A VITE / ESPÁRRAGO
		203	945128 00000	945348-00000	SECHSKANTSCHRAUBE / HEX-HEAD SCREW / VIS HEXAGONALE / VITE ESAGONALE / TORNILLO DE CABEZA HEXAGONAL
		370	011400 22200		DISTANZSCHEIBE / DISTANCE-DISK / DISQUE AJUSTAGE / DISCO DISTANZA / ARANDELA DISTANCIADORA
		371	945341 00000		INNENSECHSKANTSCHRAUBE / SOCKETHEAD SCREW / VIS HEXAGONALE INTERNE / VITE ESAGONALE INTERNA / TORNILLO HEXAGONAL INTERIOR
		374	560500 22200		KÜHLER, KOMPLETT / COOLER, COMPLETE / REFRROIDISSEUR, COMPLET / RAFFREDDATORE, COMPLETE / REFRIGERADOR COMPLETO
		425	535002 99619	535001-99619	SICHERHEITSENTIL 0.1 BAR (ABS.) / RELIEF VALVE / SOUPAPE DE SURETE / VALVOLA SICUREZZA / VÁLVULA ASEGURADORA
		502	945347 00000		INNENSECHSKANTSCHRAUBE / SOCKETHEAD SCREW / VIS HEXAGONALE INTERNE / VITE ESAGONALE INTERNA / TORNILLO HEXAGONAL INTERIOR
		503	040202 22200		FILTERDECKEL / FILTER COVER / COUVERCLE DU FILTRE / COPERCHIO FILTRO / TAPA DE FILTRO
		504	009000 27000		FEDER / SPRING / RESSORT / MOLLA / MUELLE
		505	948705 00000		KERBNAGEL / SLOTTED PIN / GOUPILLE A ENCOCHE / PERNO / CLAVO ESTRIADO
		506	912832 00000		STOPFEN / PLUG / BOUCHON / TAPPO / TAPÓN
		507	909510 00000		FILTERPATRONE / FILTER CARTRIDGE / CARTOUCHE FILTRANTE / CARTUCCIA FILTRO / CARTUCHO DE FILTRO
	511	008901 22200		DICHTUNG / GASKET / JOINT / GUARNIZIONE / JUNTA	
	512	008902 22200		DICHTUNG / GASKET / JOINT / GUARNIZIONE / JUNTA	
	513	040102 22200		FILTERGEHÄUSE / FILTER HOUSING / BOITE POUR FILTRE / CONTENITORE FILTRO / CARCASA DE FILTRO	
② DVTLF 250 KSK - mit Kühler und Spülkühler - with special cooler - avec refroidisseur spécial - con radiatore speciale - con refrigerador especial		1	000101 22200	000100-22200	GEHÄUSE / PUMP BODY / CORP DE POMPE / CARCASSA / CARCASA
		50	011401 22200	011400-22200	DISTANZSCHEIBE / DISTANCE-DISK / DISQUE AJUSTAGE / DISCO DISTANZA / ARANDELA DISTANCIADORA
		202	951035 00000	954022-00000	STIFTSCHRAUBE / STUD / PRISONNIER / L'ASTA A VITE / ESPÁRRAGO
		203	945128 00000	945348-00000	SECHSKANTSCHRAUBE / HEX-HEAD SCREW / VIS HEXAGONALE / VITE ESAGONALE / TORNILLO DE CABEZA HEXAGONAL
		370	011400 22200		DISTANZSCHEIBE / DISTANCE-DISK / DISQUE AJUSTAGE / DISCO DISTANZA / ARANDELA DISTANCIADORA
		371	945341 00000		INNENSECHSKANTSCHRAUBE / SOCKETHEAD SCREW / VIS HEXAGONALE INTERNE / VITE ESAGONALE INTERNA / TORNILLO HEXAGONAL INTERIOR
		374	560500 22200		KÜHLER, KOMPLETT / COOLER, COMPLETE / REFRROIDISSEUR, COMPLET / RAFFREDDATORE, COMPLETE / REFRIGERADOR COMPLETO
		425	535002 99619	535001-99619	SICHERHEITSENTIL 0.1 BAR (ABS.) / RELIEF VALVE / SOUPAPE DE SURETE / VALVOLA SICUREZZA / VÁLVULA ASEGURADORA
		502	945347 00000		INNENSECHSKANTSCHRAUBE / SOCKETHEAD SCREW / VIS HEXAGONALE INTERNE / VITE ESAGONALE INTERNA / TORNILLO HEXAGONAL INTERIOR
		503	040202 22200		FILTERDECKEL / FILTER COVER / COUVERCLE DU FILTRE / COPERCHIO FILTRO / TAPA DE FILTRO
		504	009000 27000		FEDER / SPRING / RESSORT / MOLLA / MUELLE
		505	948705 00000		KERBNAGEL / SLOTTED PIN / GOUPILLE A ENCOCHE / PERNO / CLAVO ESTRIADO
		506	912832 00000		STOPFEN / PLUG / BOUCHON / TAPPO / TAPÓN
		507	909510 00000		FILTERPATRONE / FILTER CARTRIDGE / CARTOUCHE FILTRANTE / CARTUCCIA FILTRO / CARTUCHO DE FILTRO
	511	008901 22200		DICHTUNG / GASKET / JOINT / GUARNIZIONE / JUNTA	
	512	008902 22200		DICHTUNG / GASKET / JOINT / GUARNIZIONE / JUNTA	
	513	040102 22200		FILTERGEHÄUSE / FILTER HOUSING / BOITE POUR FILTRE / CONTENITORE FILTRO / CARCASA DE FILTRO	
	621	560202 22200		KÜHLER, KOMPLETT / COOLER, COMPLETE / REFRROIDISSEUR, COMPLET / RAFFREDDATORE, COMPLETE / REFRIGERADOR COMPLETO	

²⁾ variantenabhängige Bauteile / variant-dependent components / composants variante-dependantes / componenti variante-dispendenti / componentes variante-dependientes

()TLF 200 ()TLF 250 ()TLF 360	Variante 	Pos. ²⁾	Bestell Nr. / Ident No. / No. Identification / No. Identificazione / No. De pedido		Beschreibung / Description / Designation / Designazione / Desripcion
					
③ DTLF 250/0-44 - ohne Ansaugfilter - without suction filter - sans filtre d'aspiration - senza filtro d'aspirazione - sin filtro de aspiración		110		952006-00000	SPANNHÜLSE / LOCATING PEG / DOVILLE DE ETRAGE / SPINE DI RISCONTRO / CASQUILLO TENSOR
		111		042600-10100	SCHLAUCH / TUBE FLEXIBLE / TUBE FLEXIBLE / TUBO FLESSIBILE / MANGUERA
		118		909534-00000	FILTERPATRONE / FILTER CARTRIDGE / CARTOUCHE FILTRANTE / CARTUCCIA FILTRO / CARTUCHO DE FILTRO
		123		828600-99216	FEDER / SPRING / RESSORT / MOLLA / MUELLE
④ DTLF 250/0-72 VTLF 250/0-72 DVTLF 250/0-72 - größere Filter - bigger filters - plus grand filtres - filtri più grandi - filtros más grandes		118	909559 00000	909534-00000	FILTERPATRONE / FILTER CARTRIDGE / CARTOUCHE FILTRANTE / CARTUCCIA FILTRO / CARTUCHO DE FILTRO
		120	040205 22200	040206-22200	FILTERDECKEL / FILTER COVER / COUVERCLE DU FILTRE / COPERCHIO FILTRO / TAPA DE FILTRO
		121	946968 00000	945336-00000	SCHRAUBE / SCREW / VIS / VITE / TORNILLO
		122	921501 50000		HANDGRIFF / KNOB / BOUTON / MANOPOLA / PERILLA
⑤ DTLF 250/6 VTLF 250/6 - Korrosionsschutz - corrosion protection - protection contre la corrosion - protezione anti-corrosione - protección contra la corrosión		1	000111 22200	000100-22200	GEHÄUSE / PUMP BODY / CORP DE POMPE / CARCASSA / CARCASA
		5	020011 22200	020000-22200	KOLBEN / ROTOR / PISTON / ROTORE / ÉMBOLO
		11	000711 22200	000700-22200	SEITENDECKEL / LID LATERAL / COUVERCLE LATÉRAL / COPERCHIO LATERALE / TAPA LATERAL
		12	000811 22200	000800-22200	SEITENDECKEL / LID LATERAL / COUVERCLE LATÉRAL / COPERCHIO LATERALE / TAPA LATERAL
⑥ VTLF 200/6-73 VTLF 250/6-73 - Korrosionsschutz - corrosion protection - protection contre la corrosion - protezione anti-corrosione - protección contra la corrosión		1	000111 22200	000100-22200	GEHÄUSE / PUMP BODY / CORP DE POMPE / CARCASSA / CARCASA
		5	020011 22200	020000-22200	KOLBEN / ROTOR / PISTON / ROTORE / ÉMBOLO
		11	000711 22200	000700-22200	SEITENDECKEL / LID LATERAL / COUVERCLE LATÉRAL / COPERCHIO LATERALE / TAPA LATERAL
		12	000811 22200	000800-22200	SEITENDECKEL / LID LATERAL / COUVERCLE LATÉRAL / COPERCHIO LATERALE / TAPA LATERAL
		118	909541 00000	909534-00000	FILTERPATRONE / FILTER CARTRIDGE / CARTOUCHE FILTRANTE / CARTUCCIA FILTRO / CARTUCHO DE FILTRO
⑦ VTLF 200/9 VTLF 250/9 - Korrosionsschutz - corrosion protection - protection contre la corrosion - protezione anti-corrosione - protección contra la corrosión		1	000111 22200	000100-22200	GEHÄUSE / PUMP BODY / CORP DE POMPE / CARCASSA / CARCASA
		5	020012 22200	020000-22200	KOLBEN / ROTOR / PISTON / ROTORE / ÉMBOLO
		7	901318 00005	901367-01005	(SATZ / KIT) SCHIEBER / VANES / PALETTE / PALETTE / EMPUJADOR
		11	000711 22200	000700-22200	SEITENDECKEL / LID LATERAL / COUVERCLE LATÉRAL / COPERCHIO LATERALE / TAPA LATERAL
		12	000811 22200	000800-22200	SEITENDECKEL / LID LATERAL / COUVERCLE LATÉRAL / COPERCHIO LATERALE / TAPA LATERAL

²⁾ variantenabhängige Bauteile / variant-dependent components / composants variante-dependantes / componenti variante-dispendenti / componentes variante-dependientes