

**DTLF / VTLF 400**  
**DTLF / VTLF 500**

**Ersatzteilliste**  
**Spare parts list**  
**Liste de pièces de rechange**  
**Listino pezzi di ricambio**  
**Lista de piezas de recambio**  
**Lista de peças sobresselentes**  
**Reserveonderdelenlijst**  
**Reservedelsliste**  
**Reservdelslista**

**Reservedelsliste**  
**Varaosaluettelo**  
**Wykaz części zamiennych**  
**Seznam náhradních dílů**  
**Tartalékalkatrész lista**  
**Κατάλογος ανταλλακτικών**  
**Yedek parça listesi**  
**Перечень запасных частей**  
**备用零件目录**  
**スペアパーツリスト**

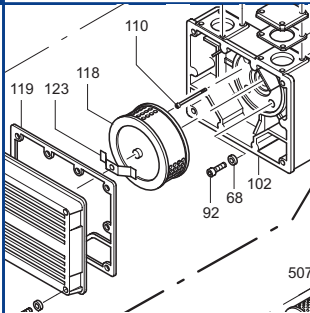

**SERVICE**

**BECKER**  
D-42279 Wuppertal  
www.becker-international.com

No. **A** year XXXX

type **VTLF 500-XX** Index Variante

frequency XXXX Hz

speed XXXX min<sup>-1</sup>

power required XXXX kW

inlet capacity XXXX m<sup>3</sup>/h

pressure + XXXX mbar

vacuum - XXXX mbar

Made in Germany

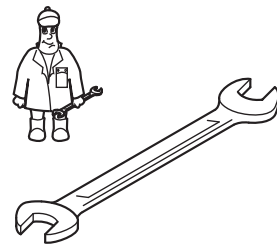
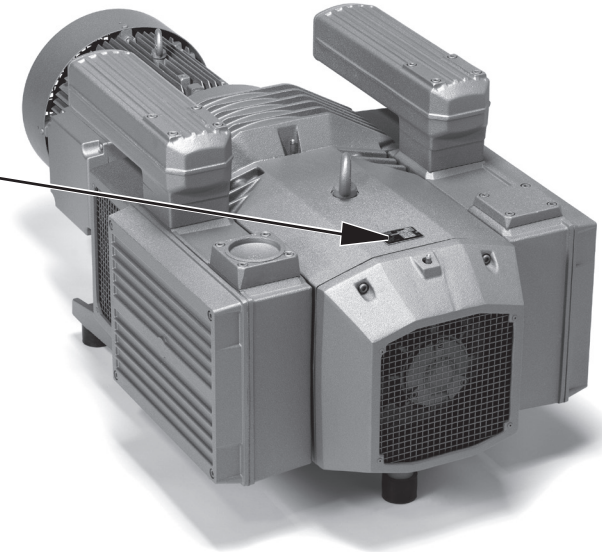

**Wartung**  
**Maintenance**  
**Entretien**  
**Manutenzione**  
**Mantenimiento**



Pos.	Menge <sup>2)</sup> Quantity Quantité Quantità Cantidad	Bestell-Nr. Ident No. No. Identification No. Identificazione No. de pedido	Bezeichnung Description Designation Designazione Descripción
□	1	549000 22500	Dichtungssatz, Complete set of seals, Jeu de joints, Kit di guarnizioni, Junta completa
7	SATZ/KIT	901373 01010	Schieber, Rotor Vane, Palette, Empujador
118	1 1 <sup>3)</sup>	909540 00000 909550 00000	Filterpatrone, Filter cartridge, Cartouche Filtrante, Cartuccia filtro, Cartucho de filtro
507	2 <sup>3)</sup>	909510 00000	Filterpatrone, Filter cartridge, Cartouche Filtrante, Cartuccia filtro, Cartucho de filtro

<sup>2)</sup> erforderliche Bestellmenge / necessary order quantity / quantité nécessaire / quantità di ordinazione necessari / cantidad necesario  
<sup>3)</sup> variantenabhängig / variant-dependent / variante-dependantes / variante-dispendenti / variante-dependientes

( )TLF 400  
 ( )TLF 500



**Standard**

**Variante**

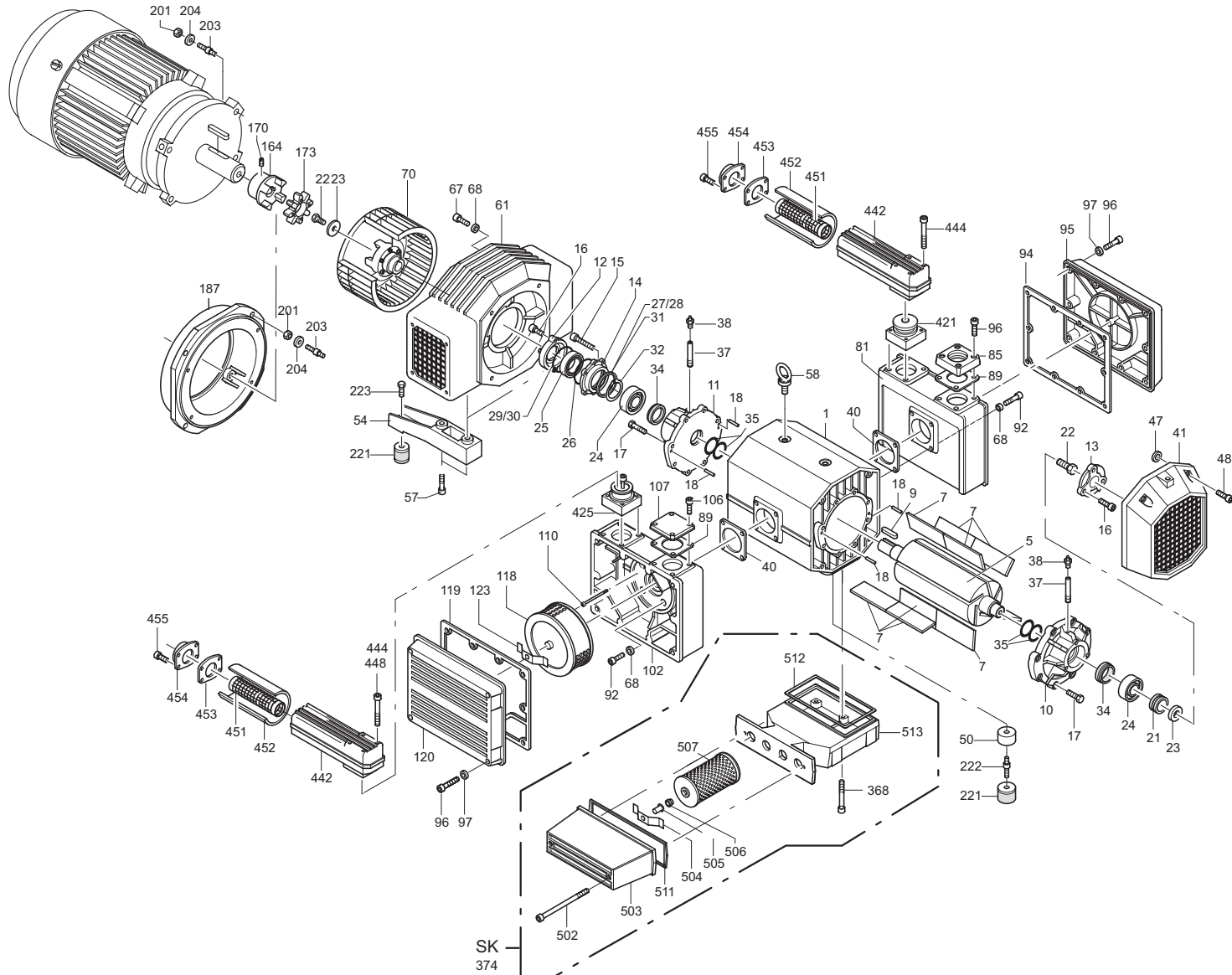
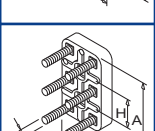
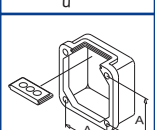
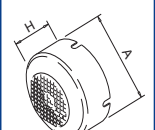
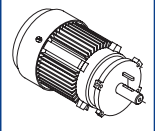

- ①  
VTLF 400 SK  
VTLF 500 SK
- ②  
VTLF 400/6  
VTLF 500/6  
DTLF 500/6
- ③  
VTLF 400/6-73  
VTLF 500/6-73



**SERVICE** ? 

INDEX	Pos.	Bestell Nr.	Beschreibung	
<b>( )TLF 400-500</b>	□	549000 22500	<b>DICHTUNGSSATZ</b> <sup>1)</sup>	
	1	000100 22500	GEHÄUSE	
	5	020000 22500	KOLBEN	
	7	901373 01010	<b>KOHLESCHIEBER (SATZ)</b>	
	9	947814 00000	PASSFEDER	
	10	000700 22500	SEITENDECKEL	
	11	000800 22500	SEITENDECKEL	
	12	001100 22500	LAGERDECKEL	
	13	001000 22500	LAGERDECKEL	
	14	001101 22500	LAGERDECKEL	
	15	945322 00000	INNENSECHSKANTSCHRAUBE	
	16	945319 00000	INNENSECHSKANTSCHRAUBE	
	17	945230 00000	SECHSKANTSCHRAUBE	
	18	948743 00000	KERBSTIFT	
	21	068900 22500	FETT-TRANSPORTRING	
	22	945270 00000	WELLENENDSCHRAUBE	
	23	968001 60000	DISTANZSCHEIBE	
	24	906614 00000	ZYLINDERROLLENLAGER (2x)	
	25	906636 00000	WÄLZLAGER	
26	913112 50100	O-RING		
27	911450 00000	ZWISCHENLEGRING 45X55X0,025		
28	911451 00000	ZWISCHENLEGRING 45X55X0,05		
29	911413 60000	ZWISCHENLEGRING 65X85X0,025		
30	911413 70000	ZWISCHENLEGRING 65X85X0,05		
31	917162 00000	AUSGLEICHSCHEIBE		
32	948265 00000	SICHERUNGSRING		
34	906580 00000	WELLENDICHRING		
35	911326 00000	DICHTUNGSSCHLAUCH		
37	008100 22200	FETTDRUCKROHR		
38	949001 00000	SCHMIERNIPPEL		
40	003100 22500	DICHTUNG		
41	520800 22500	LUFTLEITHAUBE KOMPL.		
47	009600 10100	GUMMIDÄMPFER		
48	945333 00000	INNENSECHSKANTSCHRAUBE		
50	068000 22500	DISTANZSTÜCK		
54	015100 22500	FUSS		
57	945382 00000	INNENSECHSKANTSCHRAUBE		
58	948804 00000	RINGSCHRAUBE		
61	560200 22500	LATERNE KOMPL.		
67	945361 00000	INNENSECHSKANTSCHRAUBE		
68	947507 00000	UNTERLEGSCHNEIBE		
70	544500 22500	KUPPLUNGSHÄLFTE MIT VENTILATOR		
81	040101 22500	FILTERGEHÄUSE		
85	007800 22500	GEWINDEFLENSCH		
89	007900 22500	DICHTUNG		
92	945362 00000	INNENSECHSKANTSCHRAUBE		
94	003000 22500	DICHTUNG		
95	040201 22500	FILTERDECKEL		
96	945338 00000	INNENSECHSKANTSCHRAUBE		
97	950308 00000	UNTERLEGSCHNEIBE		
102	040100 22500	FILTERGEHÄUSE		
106	945330 00000	INNENSECHSKANTSCHRAUBE		
107	005600 22500	VERSCHLUSSPLATTE		
110	945373 00000	INNENSECHSKANTSCHRAUBE		
118	909540 00000	<b>FILTERPATRONE C18133 (1x)</b> <sup>2)</sup>		
119	008900 22500	DICHTUNG		
120	040200 22500	FILTERDECKEL		
123	009000 27000	ANPRESSFEDER		
164	002100 22500	MOTORKUPPLUNG, Ø48MM		

INDEX	Pos.	Bestell Nr.	Beschreibung	
	164	002101 22500	MOTORKUPPLUNG, Ø55MM	
	164	002102 22500	MOTORKUPPLUNG, Ø60MM	
	170	946114 00000	GEWINDESTIFT	
	173	902230 00000	KUPPLUNGSSCHEIBE	
	187	500900 22500	MOTORFLANSCH, B5/350	
	187	500901 22500	MOTORFLANSCH, B5/400	
	187	500902 22500	MOTORFLANSCH, B5/450	
	201	947109 00000	SECHSKANTMUTTER	
	203	946962 00000	STIFTSCHRAUBE	
	204	947509 00000	U-SCHEIBE	
	221	741341 00000	GUMMIPUFFER	
	222	946961 00000	STIFTSCHRAUBE	
	223	945241 00000	SECHSKANTSCHRAUBE	
	421	533700 99620	DRUCKSICHERHEITSVENTIL, 1-1.7BAR	
	421	533702 99620	ABBLASEVENTIL, 0.15BAR	
	421	533703 99620	DRUCKSICHERHEITSVENTIL, <1BAR	
	425	533701 99620	VAKUUMSICHERHEITSVENTIL	
	442	007400 22500	SCHALLDÄMPFERGEHÄUSE	
	444	945384 00000	INNENSECHSKANTSCHRAUBE, M8X190	
	448	945346 00000	INNENSECHSKANTSCHRAUBE, M8X140	
	451	007601 16900	SIEBROHR	
	452	907700 90000	DÄMPFER	
	453	007501 16600	DICHTUNG	
	454	007800 16600	ANSCHLUSSFLANSCH	
	455	945320 00000	INNENSECHSKANTSCHRAUBE	
		743303 00000	<b>SPEZIALFETT (FETTPRESSE, 50g)</b>	

<sup>1)</sup> Dichtungssatz - 54900022500 - Pos.: 26, 35, 40, 89, 94, 119  
<sup>2)</sup> erforderliche Bestellmenge / Wartung

INDEX	Pos.	Ident No.	Description	
<b>( )TLF 400-500</b>	□	549000 22500	<b>GASKET SET <sup>1)</sup></b>	
	1	000100 22500	PUMP BODY	
	5	020000 22500	ROTOR	
	7	901373 01010	<b>ROTOR VANES (KIT)</b>	
	9	947814 00000	KEY	
	10	000700 22500	LID	
	11	000800 22500	LID	
	12	001100 22500	BEARING COVER	
	13	001000 22500	BEARING COVER	
	14	001101 22500	BEARING COVER	
	15	945322 00000	SOCKET HEAD SCREW	
	16	945319 00000	SOCKET HEAD SCREW	
	17	945230 00000	HEX-HEAD SCREW	
	18	948743 00000	GROOVED PIN	
	21	068900 22500	GREASE DISTRIBUTION WASHER	
	22	945270 00000	SHAFT END BOLD	
	23	968001 60000	DISTANCE DISC	
	24	906614 00000	BEARING	
25	906636 00000	BALL BEARING		
26	913112 50100	O-RING		
27	911450 00000	DISTANCE DISC 45X55X0,025		
28	911451 00000	DISTANCE DISC 45X55X0,05		
29	911413 60000	DISTANCE DISC 65X85X0,025		
30	911413 70000	DISTANCE DISC 65X85X0,05		
31	917162 00000	COMPENSATING DISC		
32	948265 00000	LOCKING RING		
34	906580 00000	SHAFT SEALING RING		
35	911326 00000	SEAL		
37	008100 22200	CONDUIT-GREASE		
38	949001 00000	GREASE NIPPLE		
40	003100 22500	GASKET		
41	520800 22500	PROTECTIVE HOOD		
47	009600 10100	DOMPENER		
48	945333 00000	SOCKET HEAD SCREW		
50	068000 22500	SPACING COLLAR		
54	015100 22500	FOOT		
57	945382 00000	SOCKET HEAD SCREW		
58	948804 00000	RING SCREW		
61	560200 22500	CONNECTION FLANGE		
67	945361 00000	SOCKET HEAD SCREW		
68	947507 00000	WASHER		
70	544500 22500	COUPLING WITH FAN		
81	040101 22500	FILTER HOUSING		
85	007800 22500	CONNECTION FLANGE		
89	007900 22500	GASKET		
92	945362 00000	SOCKET HEAD SCREW		
94	003000 22500	GASKET		
95	040201 22500	FILTER COVER		
96	945338 00000	SOCKET HEAD SCREW		
97	950308 00000	WASHER		
102	040100 22500	FILTER HOUSING		
106	945330 00000	SOCKET HEAD SCREW		
107	005600 22500	COVER		
110	945373 00000	SOCKET HEAD SCREW		
118	909540 00000	<b>FILTER CARTRIDGE C18133 (1x) <sup>2)</sup></b>		
119	008900 22500	GASKET		
120	040200 22500	FILTER COVER		
123	009000 27000	LEAF SPRING		
164	002100 22500	COUPLING MOTOR SIDE, Ø48MM		

INDEX	Pos.	Ident No.	Description	
	164	002101 22500	COUPLING MOTOR SIDE, Ø55MM	
	164	002102 22500	COUPLING MOTOR SIDE, Ø60MM	
	170	946114 00000	THREADED PIN	
	173	902230 00000	COUPLING DISC	
	187	500900 22500	MOTOR FLANGE, B5/350	
	187	500901 22500	MOTOR FLANGE, B5/400	
	187	500902 22500	MOTOR FLANGE, B5/450	
	201	947109 00000	HEX. NUT	
	203	946962 00000	STUD	
	204	947509 00000	WASHER	
	221	741341 00000	RUBBER BUFFER	
	222	946961 00000	STUD	
	223	945241 00000	HEX. HEAD SCREW	
	421	533700 99620	PRESSURE RELIEVE VALVE, 1-1.7BAR	
	421	533702 99620	BLOW-OFF VALVE, 0.15BAR	
	421	533703 99620	PRESSURE RELIEVE VALVE, <1BAR	
	425	533701 99620	VACUUM RELIEF VALVE	
	442	007400 22500	SILENCER HOUSING	
	444	945384 00000	SOCKET HEAD SCREW, M8X190	
	448	945346 00000	SOCKET HEAD SCREW, M8X140	
	451	007601 16900	SIEVE-TUBE	
	452	907700 90000	SILENCER SPONGE	
	453	007501 16600	GASKET	
	454	007800 16600	CONNECTING FLANGE	
	455	945320 00000	SOCKET HEAD SCREW	
		743303 00000	<b>SPECIAL GREASE (GREASE PRESS, 50g)</b>	
<sup>1)</sup> Set of seals - 54900022500 - Pos.: 26, 35, 40, 89, 94, 119 <sup>2)</sup> necessary order quantity / maintenance				

INDICE	Pos.	No. Identification	Designation
()TLF 400-500	□	549000 22500	JEU DE JOINTS <sup>1)</sup>
	1	000100 22500	CARCASSE
	5	020000 22500	PISTON
	7	901373 01010	PALETTE DE CHARBON (KIT)
	9	947814 00000	CLAVETTE
	10	000700 22500	COUVERCLE
	11	000800 22500	COUVERCLE
	12	001100 22500	COUVERCLE DE ROULEMENT
	13	001000 22500	COUVERCLE DE ROULEMENT
	14	001101 22500	COUVERCLE DE ROULEMENT
	15	945322 00000	VIS HEXAGONALE INTERNE
	16	945319 00000	VIS HEXAGONALE INTERNE
	17	945230 00000	VIS HEXAGONALE
	18	948743 00000	GOUPILLE CANNELEE
	21	068900 22500	BAGUE DE TRANSPORT DE GRAISSE
	22	945270 00000	VIS BOUT D'ARBRE
	23	968001 60000	DISQUE AJUSTAGE
	24	906614 00000	ROULEMENT
	25	906636 00000	ROULEMENT A BILLES
	26	913112 50100	ANNEAU-O
	27	911450 00000	BAGUE 45X55X0,025
	28	911451 00000	BAGUE 45X55X0,05
	29	911413 60000	BAGUE 65X85X0,025
	30	911413 70000	BAGUE 65X85X0,05
	31	917162 00000	DISQUE DE COMPENSATION
	32	948265 00000	BAGUE DE SURETE
	34	906580 00000	BAGUE D'ETANCHEITE P.L'AXE
	35	911326 00000	JOINT
	37	008100 22200	TUYEAU DE GRAISSAGE
	38	949001 00000	GRAISSEUR
	40	003100 22500	JOINT
	41	520800 22500	CARTER PROTECTEUR
	47	009600 10100	AMORTISSEUR
	48	945333 00000	VIS HEXAGONALE INTERNE
	50	068000 22500	DONILLE D'ECARMENT
	54	015100 22500	PIED
	57	945382 00000	VIS HEXAGONALE INTERNE
	58	948804 00000	PITON
	61	560200 22500	BRIDE DE RACCORDEMENT
	67	945361 00000	VIS HEXAGONALE INTERNE
	68	947507 00000	RONDELLE
	70	544500 22500	ACCOUPLLEMENT AVEC VENTILATEUR
	81	040101 22500	BOITE POUR FILTRE
	85	007800 22500	BRIDE DE RACCORDEMENT
	89	007900 22500	JOINT
	92	945362 00000	VIS HEXAGONALE INTERNE
	94	003000 22500	JOINT
	95	040201 22500	COUVERCLE DU FILTRE
	96	945338 00000	VIS HEXAGONALE INTERNE
	97	950308 00000	RONDELLE
	102	040100 22500	BOITE POUR FILTRE
	106	945330 00000	VIS HEXAGONALE INTERNE
	107	005600 22500	COUVERCLE DE FERMETURE
	110	945373 00000	VIS HEXAGONALE INTERNE
	118	909540 00000	CARTOUCHE FILTRANTE C18133 (1x) <sup>2)</sup>
	119	008900 22500	JOINT
	120	040200 22500	COUVERCLE DU FILTRE
	123	009000 27000	RESSORT-JAME
	164	002100 22500	ACCOUPLLEMENT MOTEUR, Ø48MM

INDICE	Pos.	No. Identification	Designation
	164	002101 22500	ACCOUPLLEMENT MOTEUR, Ø55MM
	164	002102 22500	ACCOUPLLEMENT MOTEUR, Ø60MM
	170	946114 00000	GOUPILLE FILETEE
	173	902230 00000	DISQUE D'ACCOUPLLEMENT
	187	500900 22500	BRIDE MOTEUR, B5/350
	187	500901 22500	BRIDE MOTEUR, B5/400
	187	500902 22500	BRIDE MOTEUR, B5/450
	201	947109 00000	ECROU A 6 PANS
	203	946962 00000	TOURILLON
	204	947509 00000	RONDELLE
	221	741341 00000	AMORTISSEUR EN CAOUTCHOUC
	222	946961 00000	PRISONNIER
	223	945241 00000	VIS HEXAGONALE
	421	533700 99620	SOUPAPE DE SURERE PRESSION, 1-1.7BAR
	421	533702 99620	SILENCIEUX, 0.15BAR
	421	533703 99620	SOUPAPE DE SURERE PRESSION, <1BAR
	425	533701 99620	SOUPAPE DE SURETE VIDE
	442	007400 22500	CARCASSE SILENCIEUX
	444	945384 00000	VIS HEXAGONALE INTERNE, M8X190
	448	945346 00000	VIS HEXAGONALE INTERNE, M8X140
	451	007601 16900	TUYAU-TAMIS
	452	907700 90000	MOUSSE POUR SILENCIEUX
	453	007501 16600	JOINT
	454	007800 16600	BRIDE DE RACCORDEMENT
	455	945320 00000	VIS HEXAGONALE INTERNE
		743303 00000	GRAISSE SPECIFIQUE (POMPE A GRAISSE, 50g)



<sup>1)</sup> Jeu de joints - 54900022500 - Pos.: 26, 35, 40, 89, 94, 119  
<sup>2)</sup> quantité nécessaire / entretien

INDICE	Pos.	No. Identificazione	Designazione
TLF 400-500	□	549000 22500	<b>KIT GUARNIZIONI <sup>1)</sup></b>
	1	000100 22500	CARCASSA
	5	020000 22500	ROTORE
	7	901373 01010	<b>PALETTE (KIT)</b>
	9	947814 00000	CHIAVETTA
	10	000700 22500	COPERCHIO
	11	000800 22500	COPERCHIO
	12	001100 22500	COPERCHIO CUSCINETTO
	13	001000 22500	COPERCHIO CUSCINETTO
	14	001101 22500	COPERCHIO CUSCINETTO
	15	945322 00000	VITE ESAGONALE INTERNA
	16	945319 00000	VITE ESAGONALE INTERNA
	17	945230 00000	VITE ESAGONALE
	18	948743 00000	SPINA INTAGLIATA
	21	068900 22500	ANELLO INGRASSAGGIO
	22	945270 00000	VITE DI CHIUSURA ALBERO
	23	968001 60000	DISCO DISTANZA
	24	906614 00000	CUSCINETTO
	25	906636 00000	CUSCINETTO A SFERA
26	913112 50100	ANELLO-O	
27	911450 00000	DISCO GIUOCO 45X55X0,025	
28	911451 00000	DISCO GIUOCO 45X55X0,05	
29	911413 60000	DISCO GIUOCO 65X85X0,025	
30	911413 70000	DISCO GIUOCO 65X85X0,05	
31	917162 00000	DISCO COMPENSATORE	
32	948265 00000	ANELLO DI SICUREZZA	
34	906580 00000	GUARNIZIONE PER L'ALBERO	
35	911326 00000	GUARNIZIONE	
37	008100 22200	TUBETTO D'INGRASSAGGIO	
38	949001 00000	RACCORDO DI LUBRIFICAZIONE	
40	003100 22500	GUARNIZIONE	
41	520800 22500	CARTER DI PROTEZIONE	
47	009600 10100	AMMORTIZZATORE	
48	945333 00000	VITE ESAGONALE INTERNA	
50	068000 22500	BOCCOLA DISTANZIATRICE	
54	015100 22500	PIEDE	
57	945382 00000	VITE ESAGONALE INTERNA	
58	948804 00000	GANCIO	
61	560200 22500	FLANGIA DI RACCORDE	
67	945361 00000	VITE ESAGONALE INTERNA	
68	947507 00000	RONDELLA	
70	544500 22500	GIUNTO CON VENTILATORE	
81	040101 22500	CONTENITORE FILTRO	
85	007800 22500	FLANGIA DI RACCORDE	
89	007900 22500	GUARNIZIONE	
92	945362 00000	VITE ESAGONALE INTERNA	
94	003000 22500	GUARNIZIONE	
95	040201 22500	COPERCHIO FILTRO	
96	945338 00000	VITE ESAGONALE INTERNA	
97	950308 00000	RONDELLA	
102	040100 22500	CONTENITORE FILTRO	
106	945330 00000	VITE ESAGONALE INTERNA	
107	005600 22500	COPERCHIO	
110	945373 00000	VITE ESAGONALE INTERNA	
118	909540 00000	<b>CARTUCCIA FILTRO C18133 (1x) <sup>2)</sup></b>	
119	008900 22500	GUARNIZIONI	
120	040200 22500	COPERCHIO FILTRO	
123	009000 27000	MOLLA	
164	002100 22500	GUINTO MOTORE, Ø48MM	



INDICE	Pos.	No. Identificazione	Designazione
	164	002101 22500	GUINTO MOTORE, Ø55MM
	164	002102 22500	GUINTO MOTORE, Ø60MM
	170	946114 00000	SPINA FILETTATURA
	173	902230 00000	DISCO GIUNTO
	187	500900 22500	FLANGIA MOTORE, B5/350
	187	500901 22500	FLANGIA MOTORE, B5/400
	187	500902 22500	FLANGIA MOTORE, B5/450
	201	947109 00000	DADO ESAGONALE
	203	946962 00000	VITE PRIGIONIERA
	204	947509 00000	RONDELLA PIANA
	221	741341 00000	AMMORTIZZATORE IN GOMMA
	222	946961 00000	L'ASTA A VITE
	223	945241 00000	VITE ESAGONALE
	421	533700 99620	VALVOLA SICUREZZA PRESSIONE, 1-1.7BAR
	421	533702 99620	SILENZIATORE, 0.15BAR
	421	533703 99620	VALVOLA SICUREZZA PRESSIONE, <1BAR
	425	533701 99620	VALVOLA SICUREZZA VUOTO
	442	007400 22500	CARCASSA SILEZIATORE
	444	945384 00000	VITE ESAGONALE INTERNA, M8X190
	448	945346 00000	VITE ESAGONALE INTERNA, M8X140
	451	007601 16900	TUBO-CRIVELLO
	452	907700 90000	MATERIALE PER SILENZIATORE
	453	007501 16600	GUARNIZIONE
	454	007800 16600	FLANGIA DI RACCORDO
	455	945320 00000	VITE ESAGONALE INTERNA
		 743303 00000	<b>GRASSO SPECIALE (INGRASSATORE A PISTOLA, 50g)</b>

<sup>1)</sup> Serie di guarnizione - 54900022500 - Pos.: 26, 35, 40, 89, 94, 119  
<sup>2)</sup> quantità di ordinazione necessari / manutenzione

INDICE	Pos.	No. De pedido	Descripción	
()TLF 400-500	□	549000 22500	JUEGO DE JUNTA <sup>1)</sup>	
	1	000100 22500	CARCASA	
	5	020000 22500	ÉMBOLO	
	7	901373 01010	DESPLAZADOR DE CARBÓN (KIT)	
	9	947814 00000	LENGÜETA DE AJUSTE	
	10	000700 22500	TAPA LATERAL	
	11	000800 22500	TAPA LATERAL	
	12	001100 22500	TAPA DE COJINETE	
	13	001000 22500	TAPA DE COJINETE	
	14	001101 22500	TAPA DE COJINETE	
	15	945322 00000	TORNILLO HEXAGONAL INTERIOR	
	16	945319 00000	TORNILLO HEXAGONAL INTERIOR	
	17	945230 00000	TORNILLO DE CABEZA HEXAGONAL	
	18	948743 00000	PASADOR ENTALLADO	
	21	068900 22500	ANILLO DE TRANSPORTE DE GRASA	
	22	945270 00000	TORNILLO TERMINAL DE ÁRBOL	
	23	968001 60000	ARANDELA DISTANCIADORA	
	24	906614 00000	COJINETE DE RODILLOS CILÍNDRICO NU2211 EC	
	25	906636 00000	COJINETE DE RODAMIENTO 3209/C 3	
	26	913112 50100	JUNTA TÓRICA	
	27	911450 00000	ANILLO DE COLOCACIÓN INTERMEDIO 45X55X0.025	
	28	911451 00000	ANILLO DE COLOCACIÓN INTERMEDIO 45X55X0.05	
	29	911413 60000	ANILLO DE COLOCACIÓN INTERMEDIO 65X85X0.025	
	30	911413 70000	ANILLO DE COLOCACIÓN INTERMEDIO 65X85X0.05	
	31	917162 00000	ARANDELA DE COMPENSACIÓN	
	32	948265 00000	ANILLO DE ASEGURAMIENTO	
	34	906580 00000	ANILLO DE JUNTA DE ÁRBOL	
	35	911326 00000	MANGUERA DE JUNTA	
	37	008100 22200	TUBO DE PRESIÓN DE GRASA	
	38	949001 00000	BOQUILLA DE LUBRICACIÓN	
	40	003100 22500	JUNTA	
	41	520800 22500	CAPERUZA GUÍA DE AIRE COMPLETA.	
	47	009600 10100	AMORTIGUADOR DE GOMA	
	48	945333 00000	TORNILLO HEXAGONAL INTERIOR	
	50	068000 22500	PIEZA DISTANCIADORA	
	54	015100 22500	PIE	
	57	945382 00000	TORNILLO HEXAGONAL INTERIOR	
	58	948804 00000	TORNILLO DE CÁNCAMO	
	61	560200 22500	FAROL COMPLETO	
	67	945361 00000	TORNILLO HEXAGONAL INTERIOR	
	68	947507 00000	ARANDELA	
	70	544500 22500	MITAD DE ACOPLAMIENTO CON VENTILADOR	
	81	040101 22500	CARCASA DE FILTRO	
	85	007800 22500	BRIDA ROSCADA	
	89	007900 22500	JUNTA	
	92	945362 00000	TORNILLO HEXAGONAL INTERIOR	
	94	003000 22500	JUNTA	
	95	040201 22500	TAPA DE FILTRO	
	96	945338 00000	TORNILLO HEXAGONAL INTERIOR	
	97	950308 00000	ARANDELA	
	102	040100 22500	CARCASA DE FILTRO	
	106	945330 00000	TORNILLO HEXAGONAL INTERIOR	
	107	005600 22500	PLACA DE CIERRE	
	110	945373 00000	TORNILLO HEXAGONAL INTERIOR	
	118	909540 00000	<b>CARTUCHO C18133 (1x) <sup>2)</sup></b>	
	119	008900 22500	JUNTA DE GOMA	
	120	040200 22500	TAPA DE FILTRO	
	123	009000 27000	MUELLE DE PRESIÓN	
	164	002100 22500	MITAD DE MOTOR DE ACOPLAMIENTO, Ø48MM	

INDICE	Pos.	No. De pedido	Descripción	
	164	002101 22500	MITAD DE MOTOR DE ACOPLAMIENTO, Ø55MM	
	164	002102 22500	MITAD DE MOTOR DE ACOPLAMIENTO, Ø60MM	
	170	946114 00000	VARILLA ROSCADA	
	173	902230 00000	DISCO DE ACOPLAMIENTO	
	187	500900 22500	BRIDA DE MOTOR, B5/350	
	187	500901 22500	BRIDA DE MOTOR, B5/400	
	187	500902 22500	BRIDA DE MOTOR, B5/450	
	201	947109 00000	TUERCA HEXAGONAL	
	203	946962 00000	ESPÁRRAGO	
	204	947509 00000	ARANDELA	
	221	741341 00000	AMORTIGUADOR DE GOMA	
	222	946961 00000	ESPÁRRAGO	
	223	945241 00000	TORNILLO DE CABEZA HEXAGONAL	
	421	533700 99620	VÁLVULA DE SEGURIDAD DE PRESIÓN, 1-1.7BAR	
	421	533702 99620	VÁLVULA DE BARRIDO, 0.15BAR	
	421	533703 99620	VÁLVULA DE SEGURIDAD DE PRESIÓN, <1BAR	
	425	533701 99620	VÁLVULA ASEGURADORA DE VACÍO	
	442	007400 22500	CARCASA DE SILENCIADOR	
	444	945384 00000	TORNILLO HEXAGONAL INTERIOR, M8X190	
	448	945346 00000	TORNILLO HEXAGONAL INTERIOR, M8X140	
	451	007601 16900	TUBO DE CRIBA	
	452	907700 90000	AMORTIGUADOR	
	453	007501 16600	JUNTA	
	454	007800 16600	BRIDA DE EMPALME	
	455	945320 00000	TORNILLO HEXAGONAL INTERIOR	
		743303 00000	<b>GRASA ESPECIAL (PISTOLA DE GRASA, 50g)</b>	

<sup>1)</sup> Junta completa - 54900022500 - Pos.: 26, 35, 40, 89, 94, 119  
<sup>2)</sup> cantidad necesario / mantenimiento

( )TLF 400 ( )TLF 500	Variante 	Pos. <sup>2)</sup>	Bestell Nr. / Ident No. / No. Identification / No. Identificazione / No. De pedido		Beschreibung / Description / Designation / Designazione / Desripcion
					
① VTFL 400 SK VTFL 500 SK - mit Spülkühler - with special cooler - avec refroidisseur spécial - con radiatore speciale - con refrigerador especial		1	000101 22500	000100-22500	GEHÄUSE / PUMP BODY / CORP DE POMPE / CARCASSA / CARCASA
		368	945341 00000		INNENSECHSKANTSCHRAUBE / SOCKET HEAD SCREW / VIS HEXAGONALE INTERNE / VITE ESAGONALE INTERNA / TORNILLO HEXAGONAL INTERIOR
		374	560500 22200		KÜHLER, KOMPLETT / COOLER, COMPLETE / REFRIGERISSEUR, COMPLET / RAFFREDDATORE, COMPLETE / REFRIGERADOR COMPLETO
		502	945347 00000		INNENSECHSKANTSCHRAUBE / SOCKET HEAD SCREW / VIS HEXAGONALE INTERNE / VITE ESAGONALE INTERNA / TORNILLO HEXAGONAL INTERIOR
		503	040202 22200		FILTERDECKEL / FILTER COVER / COUVERCLE DU FILTRE / COPERCHIO FILTRO / TAPA DE FILTRO
		504	009000 27000		FEDER / SPRING / RESSORT / MOLLA / MUELLE
		505	948705 00000		KERBNAGEL / SLOTTED PIN / GOUPILLE A ENCOCHE / PERNO / CLAVO ESTRIADO
		506	912832 00000		STOPFEN / PLUG / BOUCHON / TAPPO / TAPÓN
		507	909510 00000		<b>FILTERPATRONE / FILTER CARTRIDGE / CARTOUCHE FILTRANTE / CARTUCCIA FILTRO / CARTUCHO DE FILTRO</b>
		511	008901 22200		DICHTUNG / GASKET / JOINT / GUARNIZIONE / JUNTA
		512	008902 22200		DICHTUNG / GASKET / JOINT / GUARNIZIONE / JUNTA
	513	040102 22200		FILTERGEHÄUSE / FILTER HOUSING / BOITE POUR FILTRE / CONTENITORE FILTRO / CARCASA DE FILTRO	
② VTFL 400/6 VTFL 500/6 DTLF 500/6 - Korrosionsschutz - corrosion protection - protection contre la corrosion - protezione anti-corrosione - protección contra la corrosión		1	000111 22500	000100-22500	GEHÄUSE / PUMP BODY / CORP DE POMPE / CARCASSA / CARCASA
		5	020011 22500	020000-22500	KOLBEN / ROTOR / PISTON / ROTORE / ÉMBOLO
		10	000711 22500	000700-22500	SEITENDECKEL / LID LATERAL / COUVERCLE LATÉRAL / COPERCHIO LATERALE / TAPA LATERAL
		11	000811 22500	000800-22500	SEITENDECKEL / LID LATERAL / COUVERCLE LATÉRAL / COPERCHIO LATERALE / TAPA LATERAL
③ VTFL 400/6-73 VTFL 500/6-73 - Korrosionsschutz - corrosion protection - protection contre la corrosion - protezione anti-corrosione - protección contra la corrosión		1	000111 22500	000100-22500	GEHÄUSE / PUMP BODY / CORP DE POMPE / CARCASSA / CARCASA
		5	020011 22500	020000-22500	KOLBEN / ROTOR / PISTON / ROTORE / ÉMBOLO
		10	000711 22500	000700-22500	SEITENDECKEL / LID LATERAL / COUVERCLE LATÉRAL / COPERCHIO LATERALE / TAPA LATERAL
		11	000811 22500	000800-22500	SEITENDECKEL / LID LATERAL / COUVERCLE LATÉRAL / COPERCHIO LATERALE / TAPA LATERAL
		118	909550 00000	909540-00000	<b>FILTERPATRONE / FILTER CARTRIDGE / CARTOUCHE FILTRANTE / CARTUCCIA FILTRO / CARTUCHO DE FILTRO</b>

<sup>2)</sup> variantenabhängige Bauteile / variant-dependent components / composants variante-dependantes / componenti variante-dispendenti / componentes variante-dependientes