

Wartung
Maintenance
Entretien
Manutenzione
Mantenimiento

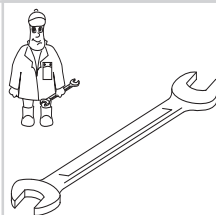

	Pos.	Menge ²⁾ Quantity Quantité Quantità Cantidad	Bestell-Nr. Ident No. No. Identification No. Identificazione No. de pedido	Bezeichnung Description Designation Designazione Descripción
U 4.100	□	1	549000 26100	Dichtungssatz, Complete set of seals, Jeu de joints, Kit di guarnizioni, Junta Completa
	5	SATZ (KIT)	900512 00003	Schieber, Rotor Vane, Palette, Silenciador
	83	1	965416 00000	Luftentölelement, Oil separating element, Element separation huile, Cartuccia separatore olio, Elemento de desaceitar de aire

²⁾ erforderliche Bestellmenge / necessary order quantity / quantité nécessaire / quantità di ordinazione necessari / cantidad necesario

Ersatzteilliste
Spare parts list
Liste de pièces de rechange
Listino pezzi di ricambio
Lista de piezas de recambio
Lista de peças sobresselentes
Reserveonderdelenlijst
Reservedelsliste
Reservdelslista

Reservedelsliste
Varaosaluettelo
Wykaz części zamiennych
Seznam náhradních dílů
Tartalékalkatrész lista
Κατάλογος ανταλλακτικών
Перечень запасных частей
备用零件目录
スペアパーツリスト

U 4.100



28006900000 06/2010

Index-F



SERVICE

Made in Germany

BECKER

Baujahr/year: XXXX

No. F: XXXX

D-42279 Wuppertal

Typ: U 4.100-XX

Drehzahl / speed: XXXX min⁻¹

Leistungsbedarf / motor power required: XXXX kW

Saugvermögen / inlet capacity: XXXX m³/h

Saugdruck / vacuum: XXXX mbar

www.BF-1.com

Index Option

Service:

Tel: +49 (0)202 697-171

Fax: +49 (0)202 64 44 74

E-Mail: info@becker-international.com

 www.becker-international.com

F
Index**U 4.100**

Pos.	Bestell Nr.	Beschreibung	
□	549000 26100	DICHTUNGSSATZ ¹⁾	
1	000101 26200	GEHÄUSE	
3	020000 26200	KOLBEN	
5	900512 00003	SCHIEBER (SATZ)	
7	917609 00000	LAGERDICHTRING	
8	917501 00000	PASS-SCHEIBE	
9	906622 00000	WÄLZLAGER	
10	906528 00000	WELLENDICHTRING	
11	948207 00000	SEEGERRING	
12	912820 00000	VERSCHLUSSDECKEL	
15	000801 26200	SEITENDECKEL	
16	000701 26200	SEITENDECKEL	
17	912871 00000	VERSCHLUSS-SCHRAUBE	
18	902000 10600	GEBLÄSEKUPPLUNG	
21	945320 00000	INNENSECHSKANTSCHRAUBE	
22	948742 00000	PASSKERBSTIFT	
24	947732 00000	PASSFEDER	
28	952008 00000	SPANNHÜLSE	
29	951705 00000	TELLERFEDER	
30	902300 26200	VENTILATOR MIT NABE	
31	947713 00000	PASSFEDER	
32	901808 00000	WELLENENDSCHRAUBE	
33	947507 00000	UNTERLEGSCHEIBE	
41	007800 26200	GEWINDEFLANSCH	
42	533900 26200	VENTILPLATTE, KOMPLETT	
44	005000 26200	SIEB	
46	948219 02000	SEEGER-RING	
49	928602 60000	DRUCKFEDER	
52	945325 00000	INNENSECHSKANTSCHRAUBE	
54	951602 00000	RINGMUTTER	
55	945814 00000	GEWINDESTIFT	
57	951228 02000	VERSCHLUSS-SCHRAUBE	
63	509400 26200	KUGELSTÜCKSCHRAUBE	
64	001702 26200	ÖLBEHÄLTERDECKEL	
67	003701 26200	DECKEL	
69	951005 02000	STIFTSCHRAUBE	
70	948504 00000	TELLERFEDER	
71	947104 00000	SECHSKANTMUTTER	
74	305800 02000	ÜBERWURFMUTTER	
76	727502 99628	ABBLASEVENTIL	
83	965416 00000	LUFENTÖLELEMENT (1x) ²⁾	
89	921500 50000	HANDGRIFF	
93	945226 00000	SECHSKANTSCHRAUBE	
94	867800 99559	SCHWIMMER	
97	912300 00000	ANSCHLUSSCHRAUBE	
98	912871 00000	VERSCHLUSS-SCHRAUBE	
101	506000 26200	GROBABSCHIEDER KOMPLETT	
104	008001 26200	FILTERBLECH	
112	003703 26200	DECKEL	
120	916800 10000	SCHRAUBDECKEL	
130	945387 00000	INNENSECHSKANTSCHRAUBE	
131	945319 00000	INNENSECHSKANTSCHRAUBE	
132	945323 00000	INNENSECHSKANTSCHRAUBE	
133	945319 00000	INNENSECHSKANTSCHRAUBE	
134	945324 00000	INNENSECHSKANTSCHRAUBE	
141	012211 26200	LEITUNG	
143	012202 26200	LEITUNG	
148	948401 00000	HOHLSCHRAUBE	
150	012209 26200	LEITUNG	
151	012205 26200	LEITUNG	

F
Index**U 4.100**

Pos.	Bestell Nr.	Beschreibung	
152	009400 19000	KUGELSTÜCKSCHRAUBE	
154	012900 19000	VERSCHLUSS-SCHRAUBE	
157	960202 26200	KÜHLER	
158	012210 26200	LEITUNG	
159	948402 00000	HOHLSCHRAUBE	
181	018300 26200	ABDECKHAUBE	
183	922400 60000	SCHUTZGITTER	
186	568001 10700	ZWISCHENSTÜCK	
187	568100 10700	STÜTZE KOMPL.	
188	949408 00000	U-SCHEIBE	
190	001800 20000	WELLENABSCHLUSS-SCHRAUBE	
192	901809 00000	SCHRAUBE	
193	949451 00000	U-SCHEIBE	
197	741310 60000	GUMMIPUFFER	
214	950700 10000	LÜSTERKLEMME	
215	946304 00000	SCHRAUBE	
216	943400 90000	TEMPERATURFÜHLER	
233	537500 10700	VENTIL, KOMPL.	
242	902101 10600	MOTORKUPPLUNGSHÄLFTE Ø28MM	
245	945117 00000	SECHSKANTSCHRAUBE	
246	948507 00000	FEDERRING	
248	902200 10600	KUPPLUNGSRING	
250	902100 26100	MOTORKUPPLUNG (US)	
251	037900 26200	ZWISCHENFLANSCH (US)	
254	945232 00000	SECHSKANTSCHRAUBE (US)	
282	741103 99682	NIVEAUGEBER - OPTIONAL	
283	948086 00000	DICHTUNG	
301	002407 26200	ÖLBEHÄLTER	
302	013301 26200	PRALLBLECH	
303	945211 00000	SECHSKANTSCHRAUBE	
304	951221 00100	VERSCHLUSS-SCHRAUBE	
306	907309 00000	ÖLSCHAUGLAS	
307	951220 00100	VERSCHLUSS-SSCHRAUBE	
310	912300 00000	ANSCHLUSS-SCHRAUBE	
311	912305 00000	ANSCHLUSS-SCHRAUBE	
312	912306 00000	ANSCHLUSS-SCHRAUBE	
314	003300 10700	DÜSE	
318	952005 00000	SPANNHÜLSE	

¹⁾ Dichtungssatz - 54900026100 - Pos.: 25, 26, 37, 38, 47, 58, 77, 79, 80, 121, 129, 149, 153, 160, 308

OPTIONAL

U 4.100 SA/K -25 Sonderausführung - mit Öl-Wasser-Kühler
-51 Sonderausführung - mit Ölbadheizung, Niveau-Geber und Thermostat
-54 Sonderausführung - mit zusätzlicher Ölblassebohrung
-58 Sonderausführung (Ventilator)
U 4.100 F Sonderausführung - ohne Kühler
U 4.100 F/K -25 Sonderausführung - mit Öl-Wasser-Kühler
-51 Sonderausführung - mit Ölbadheizung, Niveau-Geber und Thermostat
-58 Sonderausführung (Ventilator)

Abweichende Positionen zum Standardgerät - siehe Anhang 

F
Index**U 4.100**

Pos.	Ident No.	Description
□	549000 26100	COMPLETE SET OF SEALS ¹⁾
1	000101 26200	PUMP BODY
3	020000 26200	ROTOR
5	900512 00003	ROTOR VANE IN PLASTIC (KIT)
7	917609 00000	GASKET
8	917501 00000	DISTANCE DISC
9	906622 00000	BEARING
10	906528 00000	SHAFT SEALING RING
11	948207 00000	SEEGER CIRCLIP
12	912820 00000	CAP
15	000801 26200	SIDE SHIELD
16	000701 26200	SIDE SHIELD
17	912871 00000	LOCKING SCREW
18	902000 10600	COUPLING PUMP
21	945320 00000	HEX HEAD SCREW
22	948742 00000	GROOVED PIN
24	947732 00000	KEY
28	952008 00000	LOCATING PEG
29	951705 00000	SPRING DISC
30	902300 26200	FAN
31	947713 00000	KEY
32	901808 00000	SHAFT END BOLD
33	947507 00000	WASHER
41	007800 26200	FLANGE
42	533900 26200	VALVE PLATE
44	005000 26200	SIEVE
46	948219 02000	LOCKING RING
49	928602 60000	PRESSURE SPRING
52	945325 00000	SOCKET HEAD SCREW
54	951602 00000	RING UNIT
55	945814 00000	THREADED PIN
57	951228 02000	LOCKING SCREW
63	509400 26200	HOLLOW HOLDING SCREW
64	001702 26200	OIL TANK COVER
67	003701 26200	COVER
69	951005 02000	STUD
70	948504 00000	SPRING COLLAR
71	947104 00000	HEX.NUT
74	305800 02000	COUPLING NUT
76	727502 99628	BLOW-OFF VALVE
83	965416 00000	OIL SEPARATING ELEMENT (1x) ²⁾
89	921500 50000	HANDLE
93	945226 00000	HEX. HEAD SCREW
94	867800 99559	FLOAT
97	912300 00000	CONNECTING SCREW
98	912871 00000	LOCKING SCREW
101	506000 26200	COARSE SEPARATOR
104	008001 26200	SCREEN
112	003703 26200	COVER
120	916800 10000	COVER
130	945387 00000	SOCKET HEAD SCREW
131	945319 00000	SOCKET HEAD SCREW
132	945323 00000	SOCKET HEAD SCREW
133	945319 00000	SOCKET HEAD SCREW
134	945324 00000	SOCKET HEAD SCREW
141	012211 26200	PIPE
143	012202 26200	PIPE
148	948401 00000	HOLLOW SCREW
150	012209 26200	PIPE
151	012205 26200	PIPE

**F**
Index**U 4.100**

Pos.	Ident No.	Description
152	009400 19000	HOLLOW HOLDING SCREW
154	012900 19000	LOCKING SCREW
157	960202 26200	COOLER
158	012210 26200	PIPE
159	948402 00000	HOLLOW SCREW
181	018300 26200	COVERING HOOD
183	922400 60000	PROTECTIVE SHEET
186	568001 10700	INTERMEDIATE PIECE
187	568100 10700	SUPPORT PILLAR
188	949408 00000	WASHER
190	001800 20000	SCREW
192	901809 00000	SCREW
193	949451 00000	WASHER
197	741310 60000	RUBBER BUFFER
214	950700 10000	CLAMP
215	946304 00000	HEX-HEAD SCREW
216	943400 90000	TEMPERATURE PROBE
233	537500 10700	VALVE
242	902101 10600	COUPLING MOTOR SIDE Ø28MM
245	945117 00000	HEX-HEAD SCREW
246	948507 00000	SPRING WASHER
248	902200 10600	GEAR RIM
250	902100 26100	COUPLING MOTOR SIDE (US)
251	037900 26200	FLANGES (US)
254	945232 00000	HEX-HEAD SCREW (US)
282	741103 99682	OIL LEVEL CONTROL - OPTIONAL
283	948086 00000	GASKET
301	002407 26200	OIL TANK
302	013301 26200	DEFLECTING PLATE
303	945211 00000	HEX-HEAD SCREW
304	951221 00100	LOCKING SCREW
306	907309 00000	OIL SIGHT GLASS
307	951220 00100	LOCKING SCREW
310	912300 00000	CONNECTING SCREW
311	912305 00000	CONNECTING SCREW
312	912306 00000	CONNECTING SCREW
314	003300 10700	NOZZLE
318	952005 00000	LOCATING PEG

¹⁾ Set of seals - 54900026100 - Pos.: 25, 26, 37, 38, 47, 58, 77, 79, 80, 121, 129, 149, 153, 160, 308²⁾ necessary order quantity / maintenance**OPTIONAL**

U 4.100 SA/K -25	Special design – with oil-to-water heat exchanger
-51	Special design – with oil bath heating, level transmitter and heat valve
-54	Special design – with additional oil draining bore hole
-58	Special design (Fan)
U 4.100 F	Special design – without cooling apparatus
U 4.100 F/K -25	Special design – with oil-to-water heat exchanger
-51	Special design – with oil bath heating, level transmitter and heat valve
-58	Special design (Fan)

Items different from standard appliance see appendix (back of drawing) 

F
Index**U 4.100**

Pos.	No. Identification	Designation
□	549000 26100	JEU DE JOINTS ¹⁾
1	000101 26200	CARCASSE
3	020000 26200	PISTON
5	900512 00003	PALETTE ON PLASTIQUE (KIT)
7	917609 00000	JOINT
8	917501 00000	DISQUE DE TOLERANCE
9	906622 00000	ROULEMENT
10	906528 00000	BAGUE D'ETANCHEITE
11	948207 00000	FREIN D'AXES SEEGER
12	912820 00000	COUVERCLE
15	000801 26200	COUVERCLE
16	000701 26200	COUVERCLE
17	912871 00000	BOUCHON
18	902000 10600	ACCOUPEMENT POMPE
21	945320 00000	VIS HEXAGONALE INTERNE
22	948742 00000	GOUPILLE CANNELEE
24	947732 00000	CLAVETTE
28	952008 00000	DOVILLE DE ETRAGE
29	951705 00000	DISQUE DE RESSORT
30	902300 26200	VENTILATEUR
31	947713 00000	CLAVETTE
32	901808 00000	VIS BOUT D'ARBRE
33	947507 00000	RONDELLE
41	007800 26200	BRIDE
42	533900 26200	CLAPET
44	005000 26200	FILTRE
46	948219 02000	BAGUE DE SURETE
49	928602 60000	RESSORT DE PRESSION
52	945325 00000	VIS HEXAGONALE INTERNE
54	951602 00000	ECROU A ANNEAU
55	945814 00000	GOUPILLE FILETEE
57	951228 02000	BOUCHON
63	509400 26200	VIS CREUSE DE FIXATION
64	001702 26200	COUVERCLE RESERVOIR D'HUILE
67	003701 26200	COUVERCLE
69	951005 02000	PRISONNIER
70	948504 00000	RONDELLE À RESSORT
71	947104 00000	ECROU A 6PANS
74	305800 02000	ECROU
76	727502 99628	SILENCIEUX
83	965416 00000	ELEMENT SEPARATION HUILE (1x) ²⁾
89	921500 50000	POIGNEE
93	945226 00000	VIS HEXAGONALE
94	867800 99559	PIED CAOUTCHOVE
97	912300 00000	VIS DE RACCORD
98	912871 00000	BOUCHON
101	506000 26200	SEPARATEUR A GROS
104	008001 26200	TAMIS
112	003703 26200	COUVERCLE
120	916800 10000	COUVERCLE
130	945387 00000	VIS HEXAGONALE INTERNE
131	945319 00000	VIS HEXAGONALE INTERNE
132	945323 00000	VIS HEXAGONALE INTERNE
133	945319 00000	VIS HEXAGONALE INTERNE
134	945324 00000	VIS HEXAGONALE INTERNE
141	012211 26200	TUYAU
143	012202 26200	TUYAU
148	948401 00000	VIS CREUSE
150	012209 26200	TUYAU
151	012205 26200	TUYAU

F
Index**U 4.100**

Pos.	No. Identification	Designation
152	009400 19000	VIS CREUSE DE FIXATION
154	012900 19000	BUCHON
157	960202 26200	REFROIDISSEUR
158	012210 26200	TUYAU
159	948402 00000	VIS CREUSE
181	018300 26200	CARTER
183	922400 60000	TOLE DE PROTECTION
186	568001 10700	BRIDE
187	568100 10700	SUPPORT INTERMEDIAIRE
188	949408 00000	RONDELLE
190	001800 20000	VIS
192	901809 00000	VIS
193	949451 00000	RONDELLE
197	741310 60000	AMORTISSEUR EN CAOUTCHOUC
214	950700 10000	BORNE
215	946304 00000	VIS HEXAGONALE
216	943400 90000	PALPEUR DE TEMPERATURE
233	537500 10700	SOUPAPE
242	902101 10600	ACCOUPEMENT MOTEUR Ø28MM
245	945117 00000	VIS HEXAGONALE
246	948507 00000	ANNEAU RESSORT
248	902200 10600	ACCOUPEMENT ROTEX
250	902100 26100	ACCOUPEMENT MOTEUR (US)
251	037900 26200	BRIDES (US)
254	945232 00000	VIS HEXAGONALE (US)
282	741103 99682	INDICATEUR DE NIVEAU - EN OPTION
283	948086 00000	JOINT
301	002407 26200	RESERVOIR D'HUILE
302	013301 26200	DEFLECTEUR
303	945211 00000	VIS HEXAGONALE
304	951221 00100	BOUCHON
306	907309 00000	VERRE REGARD
307	951220 00100	BOUCHON
310	912300 00000	VIS DE RACCORD
311	912305 00000	VIS DE RACCORD
312	912306 00000	VIS DE RACCORD
314	003300 10700	GICLEUR
318	952005 00000	DOUILLE DE ETRAGE

¹⁾ Jeu de joints - 54900026100 - Pos.: 25, 26, 37, 38, 47, 58, 77, 79, 80, 121, 129, 149, 153, 160, 308

²⁾ quantité nécessaire / entretien

EN OPTION

U 4.100 SA/K	-25	Fabrication spéciale – avec réfrigérant à l'huile et à l'eau
	-51	Fabrication – avec chauffage du bain d'huile, capteur de niveau et thermostat
	-54	Fabrication spéciale – avec trou de vidange d'huile
	-58	Fabrication spéciale (ventilateur)
U 4.100 F		Fabrication spéciale – sans réfrigérant
U 4.100 F/K	-25	Fabrication spéciale – avec réfrigérant à l'huile et à l'eau
	-51	Fabrication – avec chauffage du bain d'huile, capteur de niveau et thermostat
	-58	Fabrication spéciale (ventilateur)

Articles divergents vis-à-vis de l'appareil standard, voir annexe (dos du dessin / du plan)

F
Index**U 4.100**

Pos.	No. Identificazione	Designazione
□	549000 26100	KIT DI GUARNIZIONI ¹⁾
1	000101 26200	CARCASSA
3	020000 26200	ROTORE
5	900512 00003	PALETTE IN PLASTICA (KIT)
7	917609 00000	GUARNIZIONE
8	917501 00000	DISCO A DISTANZA
9	906622 00000	CUSCINETTO
10	906528 00000	ANELLO DI TENUTA
11	948207 00000	ANELLO ELASTICO DI SICUREZZA
12	912820 00000	COPERCHIO
15	000801 26200	COPERCHIO
16	000701 26200	COPERCHIO
17	912871 00000	VITE DI CHIUSURA
18	902000 10600	GIUNTO POMPA
21	945320 00000	VITE ESAGONALE INTERNA
22	948742 00000	SPINA INTAGLIATA
24	947732 00000	CHIAVETTA
28	952008 00000	SPINE DI RISCONTRO
29	951705 00000	DISCO A MOLLA
30	902300 26200	VENTILATORE
31	947713 00000	CHIAVETTA
32	901808 00000	VITE DI CHIUSURA ALBERO
33	947507 00000	RONDELLA
41	007800 26200	FLANGIA
42	533900 26200	SUPPORTO VALVOLA
44	005000 26200	FILTRO
46	948219 02000	ANELLO DI SICUREZZA
49	928602 60000	MOLLA DELLA PRESSIONE
52	945325 00000	VITE ESAGONALE INTERNA
54	951602 00000	GOLFARE CON FORO FILETTATO
55	945814 00000	SPINA FILETTATURA
57	951228 02000	VITE DI CHIUSURA
63	509400 26200	VITE PASSAGGIO OLIO
64	001702 26200	COPERCHIO SERBATOIO OLIO
67	003701 26200	COPERCHIO
69	951005 02000	L'ASTA VITE
70	948504 00000	RONDELLA A MOLLA
71	947104 00000	DADO ESAGONALE
74	305800 02000	DADO DI RISVOLTO
76	727502 99628	SILENZIATORE
83	965416 00000	CARTUCCIA SEPARATORE OLIO (1x) ²⁾
89	921500 50000	MANETTA
93	945226 00000	VITE ESAGONALE
94	867800 99559	GALLEGGIANTE
97	912300 00000	ATTACO FILETTATO
98	912871 00000	VITE DI CHIUSURA
101	506000 26200	SEPARATORE GROSSOLANO
104	008001 26200	STACCIO
112	003703 26200	COPERCHIO
120	916800 10000	COPERCHIO
130	945387 00000	VITE ESAGONALE INTERNA
131	945319 00000	VITE ESAGONALE INTERNA
132	945323 00000	VITE ESAGONALE INTERNA
133	945319 00000	VITE ESAGONALE INTERNA
134	945324 00000	VITE ESAGONALE INTERNA
141	012211 26200	CONDOTTO
143	012202 26200	CONDOTTO
148	948401 00000	VITE ESAGONALE
150	012209 26200	CONDOTTO
151	012205 26200	CONDOTTO

F
Index**U 4.100**

Pos.	No. Identificazione	Designazione
152	009400 19000	VITE PASSAGGIO OLIO
154	012900 19000	VITE DI CHIUSURA
157	960202 26200	RAFFREDDATORE
158	012210 26200	CONDOTTO
159	948402 00000	VITE ESAGONALE
181	018300 26200	CARTER
183	922400 60000	GRIGLIA DI PROTEZIONE
186	568001 10700	FLANGE
187	568100 10700	SUPPORTO
188	949408 00000	RONDELLA
190	001800 20000	VITE
192	901809 00000	VITE
193	949451 00000	RONDELLA
197	741310 60000	AMMORTIZZATORE IN GOMMA
214	950700 10000	MORSETTO
215	946304 00000	VITE ESAGONALE
216	943400 90000	TASTATORE TEMPERATURE
233	537500 10700	VALVOLA
242	902101 10600	GIUNTO MOTORE Ø28MM
245	945117 00000	VITE ESAGONALE
246	948507 00000	ANELLO A MOLLA
248	902200 10600	GIUNTO ROTEX
250	902100 26100	GIUNTO MOTORE (US)
251	037900 26200	FLANGE (US)
254	945232 00000	VITE ESAGONALE (US)
282	741103 99682	SONDA D'OLIO - OPZIONALE
283	948086 00000	GUARNIZIONE
301	002407 26200	SERBATOIO OLIO
302	013301 26200	DEFLETTORE
303	945211 00000	VITE ESAGONALE
304	951221 00100	VITE DI CHIUSURA
306	907309 00000	SPIA LIVELLO OLIO
307	951220 00100	VITE DI CHIUSURA
310	912300 00000	ATTACO FILETTATO
311	912305 00000	ATTACO FILETTATO
312	912306 00000	ATTACO FILETTATO
314	003300 10700	UGELLO
318	952005 00000	SPINE DI RISCONTRO

¹⁾ Serie di guarnizione - 54900026100 - Pos.: 25, 26, 37, 38, 47, 58, 77, 79, 80, 121, 129, 149, 153, 160, 308

OPZIONALE

U 4.100 SA/K	-25	Modello speciale - con radiatore ad olio - acqua
	-51	Modello - con riscaldamento a bagno d'olio, indicatore di livello e termostato
	-54	Modello speciale - con faro di scarico dell'olio aggiuntivo
	-58	Modello speciale (ventilatore)
U 4.100 F		Modello speciale - senza radiatore
U 4.100 F/K	-25	Modello speciale - con radiatore ad olio - acqua
	-51	Modello - con riscaldamento a bagno d'olio, indicatore di livello e termostato
	-58	Modello speciale (ventilatore)

Vedere allegato (retro del disegno) per le posizioni divergenti dall'apparecchio

F
Index**U 4.100**

Pos.	No. De pedido	Descripción	
□	549000 26100	JUEGO DE JUNTA ¹⁾	
1	000101 26200	CARCASA	
3	020000 26200	ÉMBOLO	
5	900512 00003	EMPUJADOR DE PLÁSTICO (KIT)	
7	917609 00000	ANILLO DE COJINETE DE JUNTA	
8	917501 00000	ARANDELA DE AJUSTE	
9	906622 00000	COJINETE DE RODAMIENTO	
10	906528 00000	ANILLO DE JUNTA DE ÁRBOL	
11	948207 00000	ANILLO DE RETENCIÓN ELÁSTICO	
12	912820 00000	TAPA DE CIERRE	
15	000801 26200	TAPA LATERAL	
16	000701 26200	TAPA LATERAL	
17	912871 00000	TORNILLO DE CIERRE	
18	902000 10600	ACOPLAMIENTO DE SOPLADO	
21	945320 00000	TORNILLO HEXAGONAL INTERIOR	
22	948742 00000	PASADOR ENTALLADO DE AJUSTE	
24	947732 00000	LENGÜETA DE AJUSTE	
28	952008 00000	CASQUILLO TENSOR	
29	951705 00000	ARANDELA ELÁSTICA	
30	902300 26200	ALETA DE VENTILADOR	
31	947713 00000	LENGÜETA DE AJUSTE	
32	901808 00000	TORNILLO TERMINAL DE ÁRBOL	
33	947507 00000	ARANDELA	
41	007800 26200	BRIDA ROSCADA	
42	533900 26200	PLACA DE VÁLVULA, COMPLETAO	
44	005000 26200	CRIBA	
46	948219 02000	ANILLO DE ASEGURAMIENTO	
49	928602 60000	MUELLE DE COMPRESIÓN	
52	945325 00000	TORNILLO HEXAGONAL INTERIOR	
54	951602 00000	TUERCA DE CÁNCAMO	
55	945814 00000	VARILLA ROSCADA	
57	951228 02000	TORNILLO DE CIERRE	
63	509400 26200	TORNILLO DE PIEZA ESFÉRICA	
64	001702 26200	TAPA DE RECIPIENTE DE ACEITE	
67	003701 26200	TAPA	
69	951005 02000	ESPÁRRAGO	
70	948504 00000	ARANDELA DE APOYO DEL RESORTE	
71	947104 00000	TUERCA HEXAGONAL	
74	305800 02000	SOBRETUERCA	
76	727502 99628	VÁLVULA DE BARRIDO	
83	965416 00000	ELEMENTO DE DESACEITAR DE AIRE (1x) ²⁾	
89	921500 50000	EMPUÑADURA	
93	945226 00000	TORNILLO DE CABEZA HEXAGONAL	
94	867800 99559	FLOTADOR	
97	912300 00000	TORNILLO DE EMPALME	
98	912871 00000	TORNILLO DE CIERRE	
101	506000 26200	SEPARADOR DE SÓLIDOS GRUESOS COMPLETO	
104	008001 26200	CHAPA DE FILTRO	
112	003703 26200	TAPA	
120	916800 10000	TAPA ROSCADA	
130	945387 00000	TORNILLO HEXAGONAL INTERIOR	
131	945319 00000	TORNILLO HEXAGONAL INTERIOR	
132	945323 00000	TORNILLO HEXAGONAL INTERIOR	
133	945319 00000	TORNILLO HEXAGONAL INTERIOR	
134	945324 00000	TORNILLO HEXAGONAL INTERIOR	
141	012211 26200	CONDUCTO	
143	012202 26200	CONDUCTO	
148	948401 00000	TORNILLO HUECO	
150	012209 26200	CONDUCTO	
151	012205 26200	CONDUCTO	

F
Index**U 4.100**

Pos.	No. De pedido	Descripción	
152	009400 19000	TORNILLO DE PIEZA ESFÉRICA	
154	012900 19000	TORNILLO DE CIERRE	
157	960202 26200	REFRIGERADOR	
158	012210 26200	CONDUCTO	
159	948402 00000	TORNILLO HUECO	
181	018300 26200	CAPERUZA DE RECUBRIMIENTO	
183	922400 60000	REJILLA DE PROTECCIÓN	
186	568001 10700	PIEZA INTERMEDIA	
187	568100 10700	APOYO COMPLETO.	
188	949408 00000	ARANDELA	
190	001800 20000	TORNILLO TERMINAL DE ÁRBOL	
192	901809 00000	TORNILLO	
193	949451 00000	ARANDELA	
197	741310 60000	AMORTIGUADOR DE GOMA	
214	950700 10000	TERMINAL DE CABLE	
215	946304 00000	TORNILLO DE SUJECIÓN	
216	943400 90000	SENSOR DE TEMPERATURA	
233	537500 10700	VÁLVULA COMPLETA	
242	902101 10600	MITAD DE MOTOR DE ACOPLAMIENTO, Ø28MM	
245	945117 00000	TORNILLO DE CABEZA HEXAGONAL	
246	948507 00000	ARANDELA DE MUELLE	
248	902200 10600	ANILLO DE ACOPLAMIENTO ROJO	
250	902100 26100	ACOPLAMIENTO DE MOTOR (US)	
251	037900 26200	BRIDA INTERMEDIA (US)	
254	945232 00000	TORNILLO DE CABEZA HEXAGONAL (US)	
282	741103 99682	GENERADOR DE NIVEL - OPCIONAL	
283	948086 00000	JUNTA	
301	002407 26200	RECIPIENTE DE ACEITE	
302	013301 26200	DEFLECTOR	
303	945211 00000	TORNILLO DE CABEZA HEXAGONAL	
304	951221 00100	TORNILLO DE CIERRE	
306	907309 00000	CRISTAL MIRILLA DE ACEITE	
307	951220 00100	TORNILLO DE CIERRE	
310	912300 00000	TORNILLO DE EMPALME	
311	912305 00000	TORNILLO DE EMPALME	
312	912306 00000	TORNILLO DE EMPALME	
314	003300 10700	TOBERA	
318	952005 00000	CASQUILLO TENSOR	

¹⁾ Junta completa - 54900026100 - Pos.: 25, 26, 37, 38, 47, 58, 77, 79, 80, 121, 129, 149, 153, 160, 308²⁾ cantidad necesario / mantenimiento**OPCIONAL**

U 4.100 SA/K -25	Versión especial – con refrigerador aceite-agua
-51	Versión – con calefacción de baño de aceite, codificador de nivel y termostato
-54	Versión especial – con perforación de salida de aceite adicional
-58	Versión especial (ventilador)
U 4.100 F	Versión especial – sin refrigerador
U 4.100 F/K -25	Versión especial – con refrigerador aceite-agua
-51	Versión – con calefacción de baño de aceite, codificador de nivel y termostato
-58	Versión especial (ventilador)

Para posiciones que derivan del aparato standard véase apéndice (lado trasero del plano) 

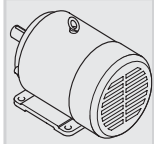

SERVICE ?

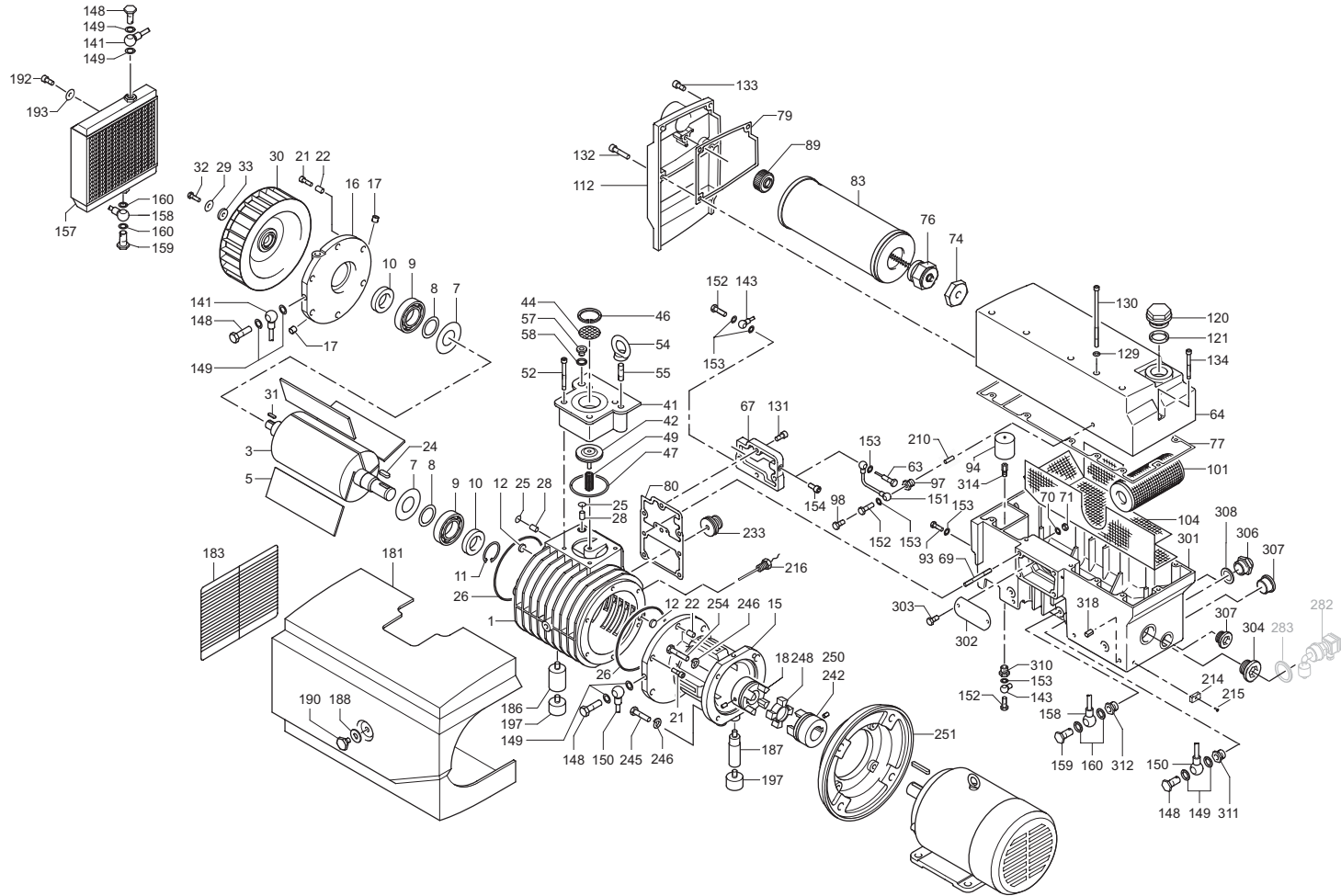
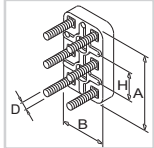
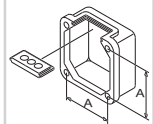
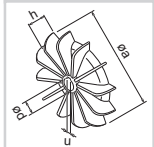
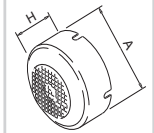



standard

U 4.100 F/K

U 4.100 SA/K

**optional
en option
opcionale
opcional**

optional en option optionale opcional 	Variante(n) Modifications Variantes	Pos ³⁾	Bestell Nr. / Ident No. / No. Identification / No. Identificazione / No. De pedido		Beschreibung / Description / Designation / Designazione / Desripcion
					
U 4.100 SA/XX U 4.100 F/XX	U 4.100 F	141 144 146 157 158 159 160 192 193	012203 26200 912305 00000	012211-26200 960202-26200 012210-26200 948402-00000 XXX 945318-00000 949203-00000	LEITUNG / PIPE / TUYAU / CONDOTTO / CONDUCTO LEITUNG / PIPE / TUYAU / CONDOTTO / CONDUCTO VERSCHLUSS-SCHRAUBE / LOCKING SCREW / BOUCHON / VITE DI CHIUSURA / TORNILLO DE CIERRE KUEHLER / COOLER / REFROIDISSEUR / RAFFREDDATORE / REFRIGERADOR LEITUNG / PIPE / TUYAU / CONDOTTO / CONDUCTO HOHLSCHRAUBE / HOLLOW SCREW / VIS CREUSE / VITE ESAGONALE / TORNILLO HUECO DICHTUNG / GASKET / JOINT / GUARNIZIONE / JUNTA SCHRAUBE / SCREW / VIS / VITE / TORNILLO U-SCHEIBE / WASHER / RONDELLE / RONDELLA / ARANDELA
	U 4.100 SA/K-25 U 4.100 F/K-25	29 30 31 32 33 98 141 150 155 157 158 181 192 193 197 198 211	912871 00000 012214 26200 012213 26200 948420 00000 960204 26200 012212 26200 018301 26200 741302 00000 945634 00000 967300 10000	951705-00000 902300-26200 947713-00000 901808-00000 947507-00000 012211-26200 012209-26200 960202-26200 012210-26200 018300-26200 945318-00000 949203-00000 741310-60000 948086 00000 002409 26200	FEDERSCHEIBE / SPRING DISC / DISQUE DE RESSORT / DISCO A MOLLA / ARANDELA ELÁSTICA VENTILATOR / FAN / VENTILATEUR / VENTILATORE / ALETA DE VENTILADOR PASSFEDER / KEY / CLAVETTE / CHIAVETTA / LENGÜETA DE AJUSTE WELLENENDSCHRAUBE / SHAFT END BOLD / VIS BOUT D'ARBRE / VITE DI CHIUSURA ALBERO / TORNILLO TERMINAL DE ÁRBOL U-SCHEIBE / WASHER / RONDELLE / RONDELLA / ARANDELA VERSCHLUSSSCHRAUBE / LOCKING SCREW / BOUCHON / VITE DI CHIUSURA / TORNILLO DE CIERRE LEITUNG / PIPE / TUYAU / CONDOTTO / CONDUCTO LEITUNG / PIPE / TUYAU / CONDOTTO / CONDUCTO HOHLSCHRAUBE / HOLLOW SCREW / VIS CREUSE / VITE ESAGONALE / TORNILLO HUECO KUEHLER / COOLER / REFROIDISSEUR / RAFFREDDATORE / REFRIGERADOR LEITUNG / PIPE / TUYAU / CONDOTTO / CONDUCTO HAUBE / PROTECTING HOOD / CARTER PROTECTEUR / CARTER DI PROTEZIONE / SOMBRERETE SCHRAUBE / SCREW / VIS / VITE / TORNILLO U-SCHEIBE / WASHER / RONDELLE / RONDELLA / ARANDELA GUMMIPUFFER / RUBBER BUFFER / AMORTISSEUR EN CAOUTCHOUC / AMMORTIZZATORE IN GOMMA / AMORTIGUADOR DE GOMA GEWINDESTIFT / THREADED PIN / GOUPILLE FILETEE / SPINA FILETTATURA / VARILLA ROSCADA L-VERSCHRAUBUNG / L-PIECE / L-PIECE / PEZZO A L / ATORNILLADURA
	U 4.100 SA/K-51 U 4.100 F/K-51	282 283 301 304 305 309 315 316 319	741103 99682 948086 00000 002409 26200 948011 00000 912314 00000 960203 26200 943400 70000 948070 00000	002407-26200 951221-00100	NIVEAUGEBER / LEVEL TRANSMITTER / CAPTEUR DE NIVEAU / INDICATORE DI LIVELLO / CODIFICADOR DE NIVEL DICHTUNG / GASKET / JOINT / GUARNIZIONI / ANILLO ÖLABSCHEIDERGEHÄUSE / HOUSING FOR OIL SEPARATION / CARCASSE POUR SEPARATION D'HUILLE / CARCASSA SEPARATORE OLIO / CARCASA SEPARADORA DE ACEITE VERSCHLUSS-SCHRAUBE / LOCKING SCREW / BOUCHON / VITE DI CHIUSURA / TORNILLO DE CIERRE DICHTUNG / GASKET / JOINT / GUARNIZIONE / JUNTA ANSCHLUSSSCHRAUBE / CONNECTION SCREW / VIS DE RACCORDEMENT / VITE DI RACCORDO / TORNILLO DE EMPALME ROHRHEIZKÖRPER / PIPE HEATER / CORPS DE CHAUFFE / SCALDIGLIA / CALEFACTOR TUBULAR TEMPERATUR-WÄCHTER / THERMOSTAT / THERMOSTAT / INTERRUPTORE TERMICO / TERMOSTATO DICHTUNG / GASKET / JOINT / GUARNIZIONE / JUNTA
	U 4.100 SA/K-54	301 307	002408 26200 951220 00100	002407-26200	ÖLABSCHEIDERGEHÄUSE / HOUSING FOR OIL SEPARATION / CARCASSE POUR SEPARATION D'HUILLE / CARCASSA SEPARATORE OLIO / CARCASA SEPARADORA DE ACEITE VERSCHLUSS-SCHRAUBE / LOCKING SCREW / BOUCHON / VITE DI CHIUSURA / TORNILLO DE CIERRE
	U 4.100 F/K-58 U 4.100 SA/K-58	29 30 32 33	502302 10700 901804 00000 949454 00000	951705-00000 902300-26200 901804-00000 947507-00000	FEDERSCHEIBE / LOCKING WASHER / RONDELLE À RESSORT / RONDELLA A MOLLA / ARANDELA DE RESORTE VENTILATOR / FAN / VENTILATEUR / VENTILATORE / VENTILADOR WELLENENDSCHRAUBE / SCREW / VIS / VITE / TORNILLO U-SCHEIBE / WASHER / RONDELLE / RONDELLA / ARANDELA

³⁾ variantenabhängige Bauteile / variant-dependent components / composants variante-dependantes / componenti variante-dispendenti / componentes variante-dependientes

