

# SV 5.300/1

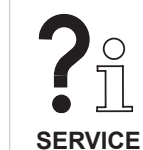
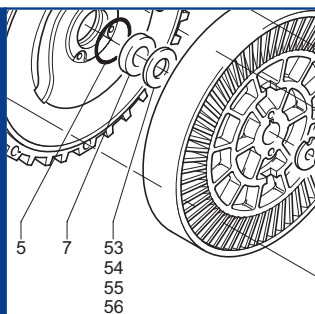

D-42279 Wuppertal  
 www.becker-international.com

year   
 No **A**

type **SV 5.300-XX**

frequency	<input type="text" value="XXXX"/>	Hz
speed	<input type="text" value="XXXX"/>	min <sup>-1</sup>
power required	<input type="text" value="XXXX"/>	kW
inlet capacity	<input type="text" value="XXXX"/>	m <sup>3</sup> /h
pressure +	<input type="text" value="XXXX"/>	mbar
vacuum -	<input type="text" value="XXXX"/>	mbar

Made in  Germany

Index Variante

**Ersatzteilliste**  
**Spare parts list**  
**Liste de pièces de rechange**  
**Listino pezzi di ricambio**  
**Lista de piezas de recambio**  
 Lista de peças sobresselentes  
 Reserveonderdelenlijst  
 Atsarginių dalių sąrašas  
 Varuosad nimekirja  
 Rezerves daļu saraksts

**Reservedelsliste**  
**Reservdelslista**  
**Varaosuettelo**  
**Reservedelsliste**  
**Wykaz części zamiennych**  
**Tartalékalkatrész lista**  
**Seznam náhradních dílů**  
**Seznam nadomestnih delov**  
**Zoznam náhradných dielov**  
**Rezervni dijelovi popis**

**Lista pieselor de schimb**  
**Páirteanna spártha liosta**  
**Κατάλογος ανταλλακτικών**  
**Yedek parça listesi**  
**Списък на резервните части**  
**Перечень запасных частей**  
**スペアパーツリスト**  
**예비 부품 목록**  
**备用零件目录**

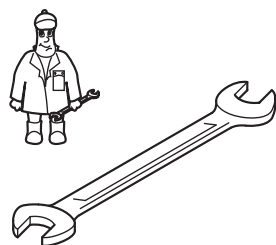

**Wartung**  
**Maintenance**  
**Entretien**  
**Manutenzione**  
**Mantenimiento**



SV 5.300/1 Standard



Variante



SV 5.300/1-XX

① /1-05  
Korrosionsschutz  
corrosion protection  
protection contre la corrosion  
protezione anti-corrosione  
protección contra la corrosión

② /1-18  
Korrosionsschutz  
corrosion protection  
protection contre la corrosion  
protezione anti-corrosione  
protección contra la corrosión

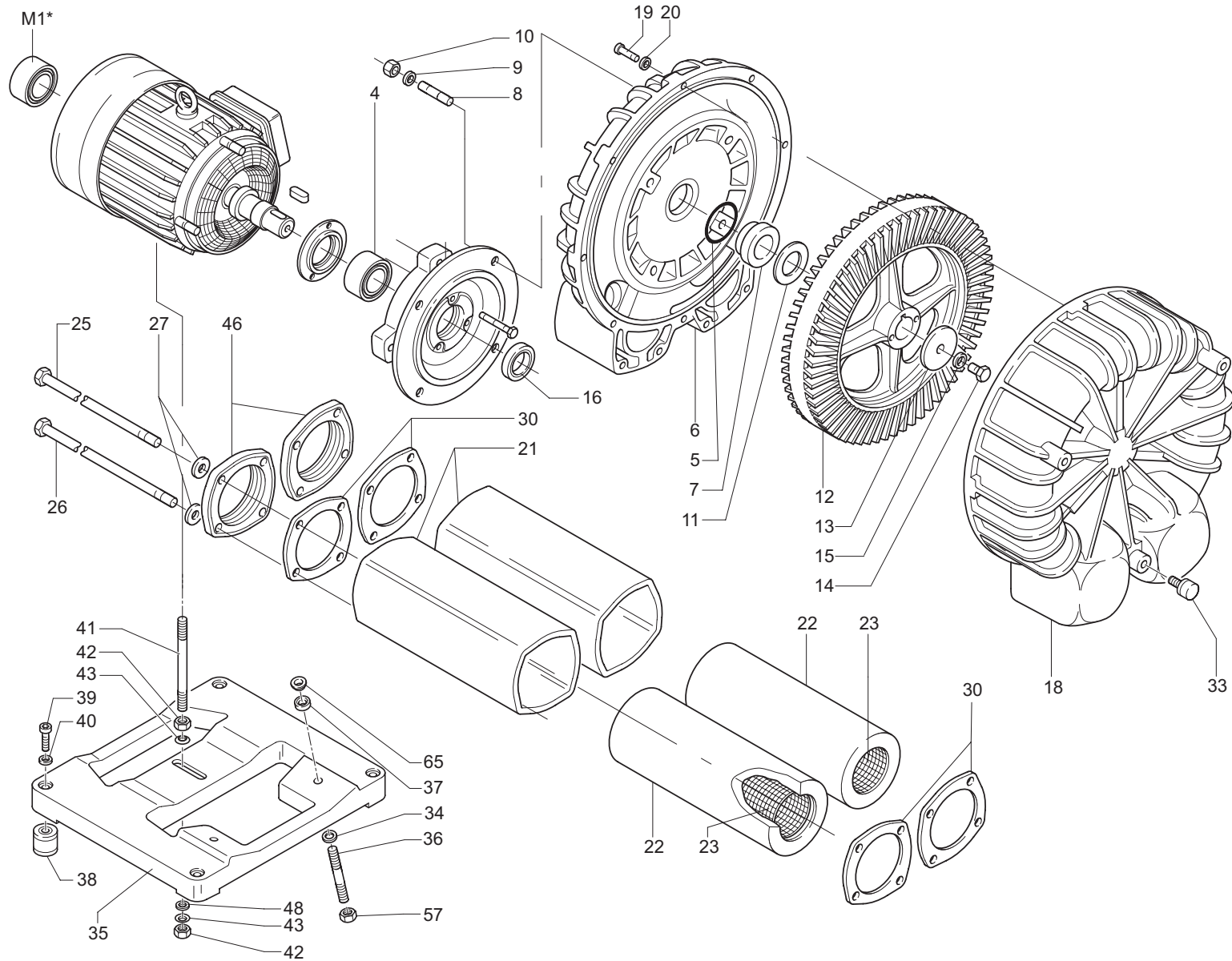

SERVICE ?

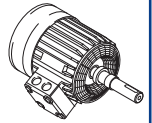

C = ?  $\mu$ F  
U = ? V

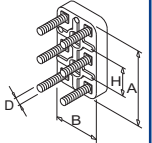
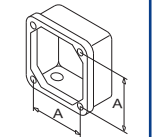
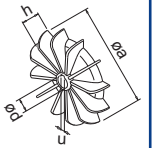
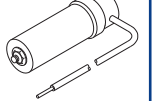

A INDEX	Pos.	Bestell Nr.	Beschreibung	
SV 5.300	4	906611 10000	WÄLZLAGER 3208 2 RS C3 TA	
	5	911317 00000	DICHTUNGSSCHLAUCH	
	6	000100 16600	GEHÄUSE	
	7	013901 16900	DISTANZBUCHSE	
	8	946937 00000	STIFTSCHRAUBE	
	9	951705 00000	FEDERSCHEIBE	
	10	947107 00000	SECHSKANTMUTTER	
	11	511400 16600	SATZ DISTANZSCHEIBEN	
	12	000600 16600	LAUFRAD	
	13	016800 16600	SPANNSCHEIBE	
	14	945243 00000	SECHSKANTSCHRAUBE	
	15	948509 00000	FEDERRING	
	16	906578 00000	WELLENDICHRING	
	18	000200 16600	GEHÄUSEDECKEL	
	19	945320 00000	INNENSECHSKANTSCHRAUBE	
	20	951703 00000	FEDERSCHEIBE	
	21	007420 16600	SCHALLDÄMPFERGEHÄUSE	
	22	007700 16600	DÄMPFER	
	23	007600 57000	SIEBROHR	
	25	003807 94000	ZUGANKERSCHRAUBE	
	26	003803 94000	ZUGANKERSCHRAUBE	
	27	951703 00000	FEDERSCHEIBE	
	30	007500 16600	DICHTUNG	
	33	741310 10000	GUMMIPUFFER	
	34	949450 00000	U-SCHEIBE	
	35	015100 16600	GERÄTEFUSS	
	36	951011 00000	STIFTSCHRAUBE	
	37	950352 00000	KEGELPFANNE	
	38	741302 00000	GUMMIPUFFER	
	39	945331 00000	INNENSECHSKANTSCHRAUBE	
	40	951707 00000	FEDERSCHEIBE	
	41	951051 00000	STIFTSCHRAUBE	
	42	947106 00000	SECHSKANTMUTTER	
43	951710 00000	FEDERSCHEIBE		
46	007800 16600	ANSCHLUSSFLANSCH		
48	949410 00000	U-SCHEIBE		
57	947105 00000	SECHSKANTMUTTER		
65	950351 00000	KUGELSCHIBE		
M1	906639 00000	MOTORLAGER 6306 <sup>1)</sup>		
M1	906635 00000	MOTORLAGER 6308 <sup>1)</sup>		
M1	906616 40000	MOTORLAGER 6208 <sup>1)</sup>		
M1	906615 50000	MOTORLAGER 6309 <sup>1)</sup>		
M1	906615 70000	MOTORLAGER 6310 <sup>1)</sup>		

<sup>1)</sup> motorabhängig / Lager sind mit Spezialfett gefüllt. Nur durch Original der Firma Gebr. Becker ersetzen.

A INDEX	Pos.	Ident No.	Description	
SV 5.300	4	906611 10000	BALL BEARING 3208 2 RS C3 TA	
	5	911317 00000	SEAL	
	6	000100 16600	PUMP BODY	
	7	013901 16900	SPACER	
	8	946937 00000	STUD	
	9	951705 00000	SPRING DISC	
	10	947107 00000	HEX. NUT	
	11	511400 16600	SET DISTANCE DISC	
	12	000600 16600	IMPELLER	
	13	016800 16600	CLAMPING DISC	
	14	945243 00000	HEX-HEAD SCREW	
	15	948509 00000	SPRING WASHER	
	16	906578 00000	SHAFT-SEALING RING	
	18	000200 16600	HOUSING LID	
	19	945320 00000	SOCKET HEAD SCREW	
	20	951703 00000	LOCKING WASHER	
	21	007420 16600	SILENCER HOUSING	
	22	007700 16600	SILENCER SPONGE	
	23	007600 57000	STRAINER TUBE	
	25	003807 94000	ANCHORING SCREW	
	26	003803 94000	ANCHORING SCREW	
	27	951703 00000	LOCKING WASHER	
	30	007500 16600	GASKET	
	33	741310 10000	RUBBER BUFFER	
	34	949450 00000	WASHER	
	35	015100 16600	FOOT	
	36	951011 00000	STUD	
	37	950352 00000	CONICAL SEAT	
	38	741302 00000	RUBBER BUFFER	
	39	945331 00000	SOCKET HEAD SCREW	
	40	951707 00000	SPRING DISC	
	41	951051 00000	STUD	
	42	947106 00000	HEX.NUT	
43	951710 00000	SPRING DISC		
46	007800 16600	CONNECTING FLANGE		
48	949410 00000	WASHER		
57	947105 00000	HEX.NUT		
65	950351 00000	SPHERICAL WASHER		
M1	906639 00000	BALL BEARING 6306 <sup>1)</sup>		
M1	906635 00000	BALL BEARING 6308 <sup>1)</sup>		
M1	906616 40000	BALL BEARING 6208 <sup>1)</sup>		
M1	906615 50000	BALL BEARING 6309 <sup>1)</sup>		
M1	906615 70000	BALL BEARING 6310 <sup>1)</sup>		

<sup>1)</sup> motor-dependent / Bearings are filled with special grease. Only be replaced by Gebrüder Beckers original.

A INDEX	Pos.	No. Identification	Designation		
SV 5.300	4	906611 10000	ROULEMENT A BILLES 3208 2 RS C3 TA		
	5	911317 00000	JOINT		
	6	000100 16600	CORP DE POMPE		
	7	013901 16900	DOUILLE		
	8	946937 00000	PRISONNIER		
	9	951705 00000	DISQUE DE RESSORT		
	10	947107 00000	ECROU A 6 PANS		
	11	511400 16600	JEU DISQUE DE TOLERANCE		
	12	000600 16600	ROUE		
	13	016800 16600	DISQUE DE SERRAGE		
	14	945243 00000	VIS HEXAGONALE		
	15	948509 00000	ANNEAU-RESSORT		
	16	906578 00000	BAGUE D'ETANCHEITE P.L'AXE		
	18	000200 16600	COUVERCLE		
	19	945320 00000	VIS HEXAGONALE INTERNE		
	20	951703 00000	RONDELLE À RESSORT		
	21	007420 16600	CARCASSE SILENCIEUX		
	22	007700 16600	MOUSSE POUR SILENCIEUX		
	23	007600 57000	GRILLE POUR SILENCIEUX		
	25	003807 94000	VIS D'ANCRAGE		
	26	003803 94000	VIS D'ANCRAGE		
	27	951703 00000	RONDELLE À RESSORT		
	30	007500 16600	JOINT		
	33	741310 10000	AMORTISSEUR EN CAOUTCHOUC		
	34	949450 00000	RONDELLE		
	35	015100 16600	PIED		
	36	951011 00000	PRISONNIER		
	37	950352 00000	RONDELLE A ROTULE CONCAVE		
	38	741302 00000	AMORTISSEUR EN CAOUTCHOUC		
	39	945331 00000	VIS HEXAGONALE INTERNE		
	40	951707 00000	DISQUE DE RESSORT		
	41	951051 00000	PRISONNIER		
	42	947106 00000	ECROU A 6 PANS		
43	951710 00000	DISQUE DE RESSORT			
46	007800 16600	BRIDE DE RACCORDEMENT			
48	949410 00000	RONDELLE			
57	947105 00000	ECROU A 6 PANS			
65	950351 00000	RONDELLE A PORTEE SPHERIQUE			
M1	906639 00000	ROULEMENT A BILLES 6306 <sup>1)</sup>			
M1	906635 00000	ROULEMENT A BILLES 6308 <sup>1)</sup>			
M1	906616 40000	ROULEMENT A BILLES 6208 <sup>1)</sup>			
M1	906615 50000	ROULEMENT A BILLES 6309 <sup>1)</sup>			
M1	906615 70000	ROULEMENT A BILLES 6310 <sup>1)</sup>			







<sup>1)</sup>dépendant du moteur / Les roulements sont remis d'une graisse spéciale. N'utiliser que de la graisse d'origine de Gebrüder Becker.

A INDEX	Pos.	No. Identificazione	Designazione		
SV 5.300	4	906611 10000	CUSCINETTO A SFERA 3208 2 RS C3 TA		
	5	911317 00000	GUARNIZIONE		
	6	000100 16600	CARCASSA		
	7	013901 16900	BOCCOLA		
	8	946937 00000	L'ASTA A VITE		
	9	951705 00000	DISCO A MOLLA		
	10	947107 00000	DADO ESAGONALE		
	11	511400 16600	SERIE DISCO GIUOCO		
	12	000600 16600	GIRANTE		
	13	016800 16600	DISCO DI FISSAGGIO		
	14	945243 00000	VITE ESAGONALE		
	15	948509 00000	ANELLO A MOLLA		
	16	906578 00000	GUARNIZIONE PER L'ALBERO		
	18	000200 16600	COPERCHIO		
	19	945320 00000	VITE ESAGONALE INTERNA		
	20	951703 00000	DISCO A MOLLA		
	21	007420 16600	CARCASSA SILENZIATORE		
	22	007700 16600	MATERIALE PER SILENZIATORE		
	23	007600 57000	TUBO-CRIVELLO		
	25	003807 94000	CHIAVARDA D'ANCORAGGIO		
	26	003803 94000	CHIAVARDA D'ANCORAGGIO		
	27	951703 00000	DISCO A MOLLA		
	30	007500 16600	GUARNIZIONE		
	33	741310 10000	AMMORTIZZATORE IN GOMMA		
	34	949450 00000	RONDELLA		
	35	015100 16600	PIASTRA DI APPOGGIO		
	36	951011 00000	L'ASTA A VITE		
	37	950352 00000	CROGIOLO		
	38	741302 00000	AMMORTIZZATORE IN GOMMA		
	39	945331 00000	VITE ESAGONALE INTERNA		
	40	951707 00000	DISCO A MOLLA		
	41	951051 00000	L'ASTA A VITE		
	42	947106 00000	DADO ESAGONALE		
43	951710 00000	DISCO A MOLLA			
46	007800 16600	FLANGIA DI RACCORDO			
48	949410 00000	RONDELLA			
57	947105 00000	DADO ESAGONALE			
65	950351 00000	CALOTTE			
M1	906639 00000	CUSCINETTO A SFERA 6306 <sup>1)</sup>			
M1	906635 00000	CUSCINETTO A SFERA 6308 <sup>1)</sup>			
M1	906616 40000	CUSCINETTO A SFERA 6208 <sup>1)</sup>			
M1	906615 50000	CUSCINETTO A SFERA 6309 <sup>1)</sup>			
M1	906615 70000	CUSCINETTO A SFERA 6310 <sup>1)</sup>			

<sup>1)</sup>dipende del motore / I cuscinetti sono riempiti di grasso speciale. Eseguire il reingrassaggio solo con grasso originale della Gebrüder Becker.

A INDICE	Pos.	No. De pedido	Descripción	
<b>SV 5.300</b>	4	906611 10000	COJINETE DE RODAMIENTO 3208 2 RS C3 TA	
	5	911317 00000	MANGUERA DE JUNTA	
	6	000100 16600	CARCASA	
	7	013901 16900	CASQUILLO DISTANCIADOR	
	8	946937 00000	ESPÁRRAGO	
	9	951705 00000	ARANDELA ELÁSTICA	
	10	947107 00000	TUERCA HEXAGONAL	
	11	511400 16600	JUEGO DE ARANDELAS DISTANCIADORAS	
	12	000600 16600	RUEDA CORREDERA	
	13	016800 16600	ARANDELA TENSORA	
	14	945243 00000	TORNILLO DE CABEZA HEXAGONAL	
	15	948509 00000	ARANDELA DE MUELLE	
	16	906578 00000	ANILLO DE JUNTA DE ÁRBOL	
	18	000200 16600	TAPA DE CARCASA	
	19	945320 00000	TORNILLO HEXAGONAL INTERIOR	
	20	951703 00000	ARANDELA ELÁSTICA	
	21	007420 16600	CARCASA DE SILENCIADOR	
	22	007700 16600	AMORTIGUADOR	
	23	007600 57000	TUBO DE CRIBA	
	25	003807 94000	TORNILLO DE ANCLAJE	
	26	003803 94000	TORNILLO DE ANCLAJE	
	27	951703 00000	ARANDELA ELÁSTICA	
	30	007500 16600	JUNTA	
	33	741310 10000	AMORTIGUADOR DE GOMA	
	34	949450 00000	ARANDELA	
	35	015100 16600	PIE DE APARATO	
	36	951011 00000	ESPÁRRAGO	
	37	950352 00000	CAZOLETA	
	38	741302 00000	AMORTIGUADOR DE GOMA	
	39	945331 00000	TORNILLO HEXAGONAL INTERIOR	
	40	951707 00000	ARANDELA ELÁSTICA	
	41	951051 00000	ESPÁRRAGO	
	42	947106 00000	TUERCA HEXAGONAL	
	43	951710 00000	ARANDELA ELÁSTICA	
	46	007800 16600	BRIDA DE EMPALME	
48	949410 00000	ARANDELA		
57	947105 00000	TUERCA HEXAGONAL		
65	950351 00000	ARANDELA ESFÉRICA		
M1	906639 00000	COJINETE DE RODAMIENTO 6306 <sup>1)</sup>		
M1	906635 00000	COJINETE DE RODAMIENTO 6308 <sup>1)</sup>		
M1	906616 40000	COJINETE DE RODAMIENTO 6208 <sup>1)</sup>		
M1	906615 50000	COJINETE DE RODAMIENTO 6309 <sup>1)</sup>		
M1	906615 70000	COJINETE DE RODAMIENTO 6310 <sup>1)</sup>		

<sup>1)</sup> dependiente del motor / Los rodamientos estan rellenos de grasa especial. Sólo reemplazar por grasa original de Gebrüder Becker.

SV5.300/1-XX Variante 	Pos. <sup>2)</sup>	Bestell Nr. / Ident No. / No. Identification / No. Identificazione / No. De pedido		Beschreibung / Description / Designation / Designazione / Desripcion
		  	  	
① /1-05 ② /1-18 Korrosionsschutz corrosion protection protection contre la corrosion protezione anti-corrosione protección contra la corrosión	6	000110 16600	<del>000100 16600</del>	GEHÄUSE / PUMP BODY / CORP DE POMPE / CARCASSA / CARCASA
	12	000610 16600	<del>000600 16600</del>	LAUFRAD / IMPELLER / ROUE / GIRANTE / RUEDA CORREDERA
	13	016810 16600	<del>016800 16600</del>	SPANNSCHEIBE / CLAMPING DISC / DISQUE DE SERRAGE / DISCO DI FISSAGGIO / ARANDELA TENSORA
	18	000210 16600	<del>948509 00000</del>	GEHÄUSEDECKEL / HOUSING LID / COUVERCLE / COPERCHIO / TAPA DE CARCASA
	21	007412 16600	<del>007420 16600</del>	SCHALLDÄMPFERGEHÄUSE / SILENCER HOUSING / CARCASSE SILENCIEUX / CARCASSA SILENZIATORE / CARCASA DE SILENCIADOR
	23	007610 57000	<del>007600 57000</del>	SIEBROHR / STRAINER TUBE / GRILLE POUR SILENCIEUX / TUBO-CRIVELLO / TUBO DE CRIBA

<sup>2)</sup> variantenabhängige Bauteile / variant-dependent components / composants variante-dependantes / componenti variante-dispendenti / componentes variante-dependientes