

X 4.10 DV X 4.16 DV

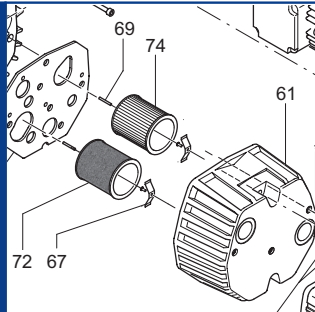

SERVICE

BECKER
D-42279 Wuppertal
www.becker-international.com

No. **A** year XXXX

type **X 4.10 DV-XX** Index Variante

frequency XXXX Hz
speed XXXX min⁻¹
power required XXXX kW
inlet capacity XXXX m³/h
pressure + XXXX mbar
vacuum - XXXX mbar

Made in Germany



Ersatzteilliste
Spare parts list
Liste de pièces de rechange
Listino pezzi di ricambio
Lista de piezas de recambio
Lista de peças sobresselentes
Reserveonderdelenlijst
Atsarginių dalių sąrašas
Varuosad nimekirja
Rezerves daļu saraksts

Reservdeliste
Reservdelista
Varaosuettelolo
Reservdeliste
Wykaz części zamiennych
Tartalékalkatrész lista
Seznam náhradních dílů
Seznam nadomestnih delov
Zoznam náhradných dielov
Rezervni dijelovi popis

Lista pieselor de schimb
Páirteanna spártha liosta
Κατάλογος ανταλλακτικών
Yedek parça listesi
Списък на резервните части
Перечень запасных частей
スペアパーツリスト
예비 부품 목록
备用零件目录

SERVICE
www.becker-international.com
Sales and service network

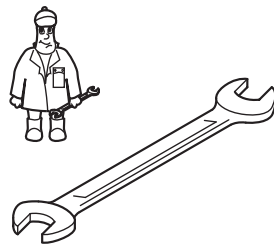

**Wartung
Maintenance
Entretien
Manutenzione
Mantenimiento**



Pos.	Menge ²⁾ Quantity Quantité Quantità Cantidad	Bestell-Nr. Ident No. No. Identification No. Identificazione No. de pedido	Bezeichnung Description Designation Designazione Descripción
X 4.10 DV			
24	SATZ/KIT	901398 00007	Schieber, Rotor Vane, Palette, Empujador
72	1	909518 01000	Filterpatrone, Filter cartridge, Cartouche Filtrante, Cartuccia filtro, Cartucho de filtro
74	1	909554 00000	Filterpatrone, Filter cartridge, Cartouche Filtrante, Cartuccia filtro, Cartucho de filtro
X 4.16 DV			
24	SATZ/KIT	901396 00007	Schieber, Rotor Vane, Palette, Empujador
72	1	909519 01000	Filterpatrone, Filter cartridge, Cartouche Filtrante, Cartuccia filtro, Cartucho de filtro
74	1	909542 00000	Filterpatrone, Filter cartridge, Cartouche Filtrante, Cartuccia filtro, Cartucho de filtro

²⁾ erforderliche Bestellmenge / necessary order quantity / quantité nécessaire / quantità di ordinazione necessari / cantidad necesario

X 4.10 DV
X 4.16 DV

Standard



Variante



X 4.10 DV/XX

①

- 1~ Einphasenwechselstrom
- 1~ single-phase AC
- 1~ AC monophasé
- 1~ AC monofase
- 1~ AC monofásica

X 4.16 DV/XX

②

- 1~ Einphasenwechselstrom
- 1~ single-phase AC
- 1~ AC monophasé
- 1~ AC monofase
- 1~ AC monofásica

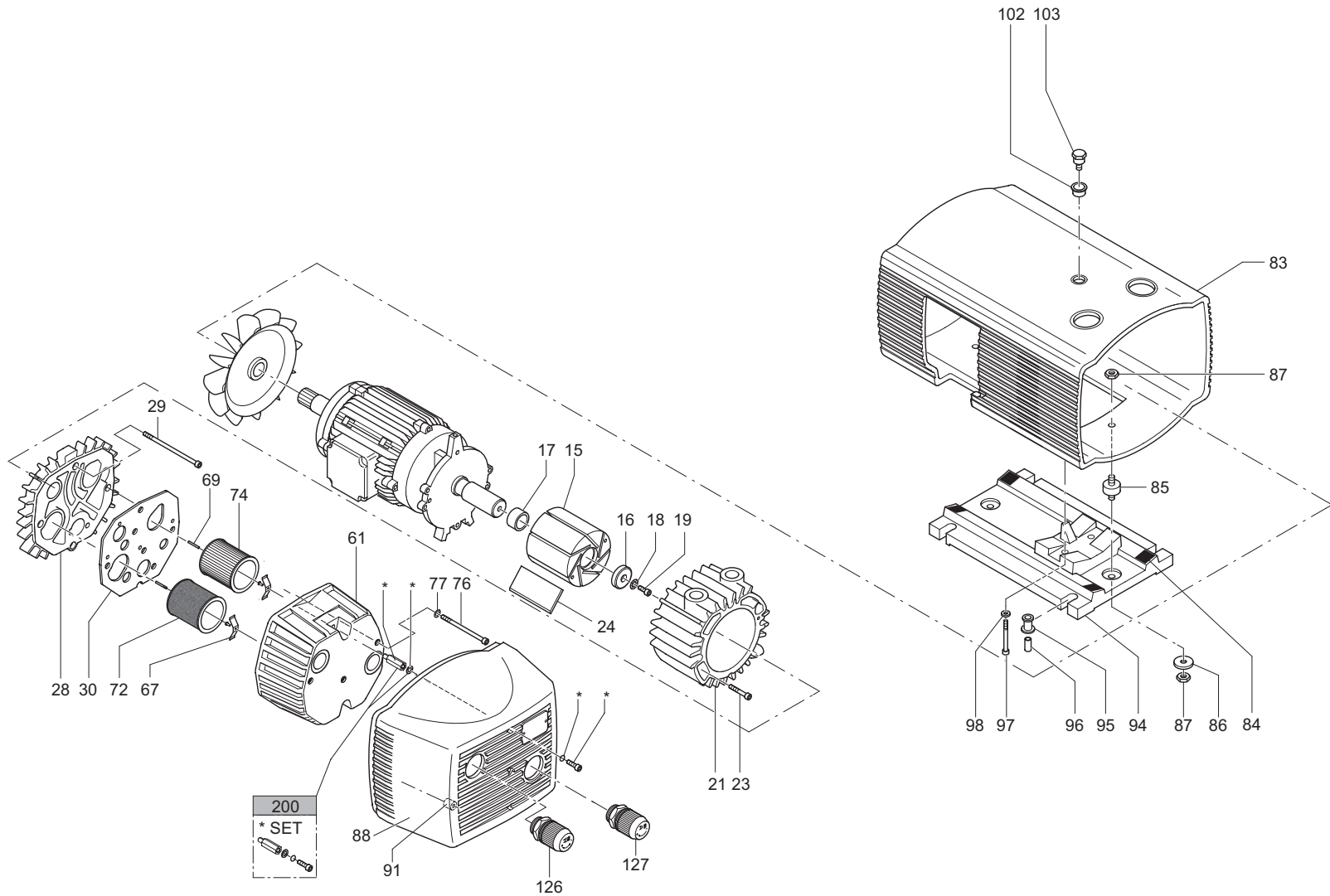

SERVICE ?

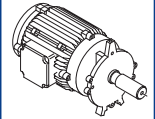

C = ? μ F
U = ? V

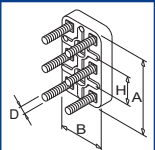
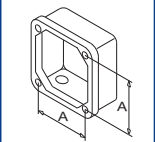
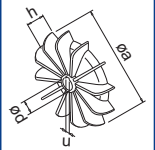
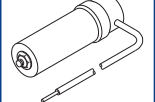

INDEX	Pos.	Bestell Nr.	Beschreibung	
X 4.10 DV	15	020000 50100	KOLBEN	
	16	016800 05000	SPANNSCHEIBE	
	17	911001 00000	STAR-TOLERANZRING	
	18	949203 00000	ZAHNSCHEIBE	
	19	945320 00000	INNENSECHSKANTSCHRAUBE	
	21	000100 16200	GEHÄUSE	
	23	945319 00000	INNENSECHSKANTSCHRAUBE	
	24	901398 00007	SCHIEBER-KOHL E (SATZ)	
	28	000700 16200	SEITENDECKEL	
	29	945364 00000	INNENSECHSKANTSCHRAUBE	
	30	008901 16200	DICHTUNG	
	61	004800 27300	FILTERDECKEL	
	67	009000 16300	ANPRESSFEDER	
	69	952009 00000	SPANNHÜLSE	
	72	909518 01000	FILTERPATRONE (1x) ¹⁾	
	74	909554 00000	PATRONE-"C"-ABSCHIEDER (1x) ¹⁾	
	76	945364 00000	INNENSECHSKANTSCHRAUBE	
	77	948021 00000	DICHTRING	
	83	006800 27300	GERÄTEHAUBE	
	84	060901 16300	DÄMPFUNGSSTREIFEN	
85	741310 50000	GUMMIPUFFER		
86	949402 00000	UNTERLEGSCHLEIBE		
87	947001 00000	SECHSKANTMUTTER		
88	006801 27400	FRONTHAUBE		
91	951922 00000	GUMMIFORMTEIL		
94	015100 27300	MOTORFUSS		
95	951921 00000	GUMMIFORMTEIL		
96	068000 27600	DISTANZSTÜCK		
97	945363 00000	INNENSECHSKANTSCHRAUBE		
98	949451 00000	UNTERLEGSCHLEIBE		
102	968104 00000	GUMMI-DISTANZSTÜCK		
103	029600 16300	BOLZEN		
126	736000 99613	VAKUUMREGULIERVENTIL		
127	728002 99611	DRUCKREGULIERVENTIL		
200	568000 27300	FRONTHAUBENBEFESTIGUNG (SATZ)		

¹⁾erforderliche Bestellmenge / Wartung

INDEX	Pos.	Bestell Nr.	Beschreibung	
X 4.16 DV	15	020000 50200	KOLBEN	
	16	016800 16300	SPANNSCHEIBE	
	17	911009 00000	STAR-TOLERANZRING	
	18	949203 00000	ZAHNSCHEIBE	
	19	945320 00000	INNENSECHSKANTSCHRAUBE	
	21	000105 16300	GEHÄUSE	
	23	945321 00000	INNENSECHSKANTSCHRAUBE	
	24	901396 00007	SCHIEBER-KOHL E (SATZ)	
	28	000705 16300	SEITENDECKEL	
	29	945372 00000	INNENSECHSKANTSCHRAUBE	
	30	008901 16300	DICHTUNG	
	61	004800 27400	FILTERDECKEL	
	67	009000 16300	ANPRESSFEDER	
	69	952009 00000	SPANNHÜLSE	
	72	909519 01000	FILTERPATRONE (1x) ¹⁾	
	74	909542 00000	PATRONE-"C"-ABSCHIEDER (1x) ¹⁾	
	76	945325 00000	INNENSECHSKANTSCHRAUBE	
	77	948021 00000	DICHTRING	
	83	006800 27400	GERÄTEHAUBE	
	84	060901 16300	DÄMPFUNGSSTREIFEN	
85	741310 50000	GUMMIPUFFER		
86	949402 00000	UNTERLEGSCHLEIBE		
87	947001 00000	SECHSKANTMUTTER		
88	006801 27400	FRONTHAUBE		
91	951922 00000	GUMMIFORMTEIL		
94	015100 27400	MOTORFUSS		
95	951921 00000	GUMMIFORMTEIL		
96	068000 27600	DISTANZSTÜCK		
97	945323 00000	INNENSECHSKANTSCHRAUBE		
98	949451 00000	UNTERLEGSCHLEIBE		
102	968104 00000	GUMMI-DISTANZSTÜCK		
103	029600 16300	BOLZEN		
126	736000 99613	VAKUUMREGULIERVENTIL		
127	728002 99611	DRUCKREGULIERVENTIL		
200	568000 27300	FRONTHAUBENBEFESTIGUNG (SATZ)		

¹⁾erforderliche Bestellmenge / Wartung

INDEX	Pos.	Ident No.	Description	
X 4.10 DV	15	020000 50100	ROTOR	
	16	016800 05000	CLAMPING DISC	
	17	911001 00000	STAR-TOLERANCE-RING	
	18	949203 00000	TOOTHED SPRING WASHER	
	19	945320 00000	SOCKET HEAD SCREW	
	21	000100 16200	PUMP BODY	
	23	945319 00000	SOCKET HEAD SCREW	
	24	901398 00007	CARBON VANES (KIT)	
	28	000700 16200	LID	
	29	945364 00000	SOCKET HEAD SCREW	
	30	008901 16200	GASKET	
	61	004800 27300	FILTER COVER	
	67	009000 16300	BLADE SPRING	
	69	952009 00000	LOCATING PIN	
	72	909518 01000	FILTER CARTRIDGE (1x) ¹⁾	
	74	909554 00000	FILTER CARTRIDGE (1x) ¹⁾	
	76	945364 00000	SOCKET HEAD SCREW	
	77	948021 00000	SEALING RING	
	83	006800 27300	PROTECTIVE HOOD	
	84	060901 16300	ELASTIC PAD	
85	741310 50000	RUBBER BUFFER		
86	949402 00000	WASHER		
87	947001 00000	HEX.NUT		
88	006801 27400	FRONT HOOD		
91	951922 00000	RUBBER ELEMENT		
94	015100 27300	FOOT		
95	951921 00000	RUBBER ELEMENT		
96	068000 27600	SPACING COLLAR		
97	945363 00000	SOCKET HEAD SCREW		
98	949451 00000	WASHER		
102	968104 00000	RUBBER SLEEVE		
103	029600 16300	BOLT		
126	736000 99613	VACUUM REGULATING VALVE		
127	728002 99611	PRESSURE REGULATING VALVE		
200	568000 27300	FRONT HOOD ATTACHMENT (KIT)		

¹⁾ necessary order quantity / maintenance

INDEX	Pos.	Ident No.	Description	
X 4.16 DV	15	020000 50200	ROTOR	
	16	016800 16300	CLAMPING DISC	
	17	911009 00000	STAR-TOLERANCE-RING	
	18	949203 00000	TOOTHED SPRING WASHER	
	19	945320 00000	SOCKET HEAD SCREW	
	21	000105 16300	PUMP BODY	
	23	945321 00000	SOCKET HEAD SCREW	
	24	901396 00007	CARBON VANES (KIT)	
	28	000705 16300	LID	
	29	945372 00000	SOCKET HEAD SCREW	
	30	008901 16300	GASKET	
	61	004800 27400	FILTER COVER	
	67	009000 16300	BLADE SPRING	
	69	952009 00000	LOCATING PIN	
	72	909519 01000	FILTER CARTRIDGE (1x) ¹⁾	
	74	909542 00000	FILTER CARTRIDGE (1x) ¹⁾	
	76	945325 00000	SOCKET HEAD SCREW	
	77	948021 00000	SEALING RING	
	83	006800 27400	PROTECTIVE HOOD	
	84	060901 16300	ELASTIC PAD	
85	741310 50000	RUBBER BUFFER		
86	949402 00000	WASHER		
87	947001 00000	HEX.NUT		
88	006801 27400	FRONT HOOD		
91	951922 00000	RUBBER ELEMENT		
94	015100 27400	FOOT		
95	951921 00000	RUBBER ELEMENT		
96	068000 27600	SPACING COLLAR		
97	945323 00000	SOCKET HEAD SCREW		
98	949451 00000	WASHER		
102	968104 00000	RUBBER SLEEVE		
103	029600 16300	BOLT		
126	736000 99613	VACUUM REGULATING VALVE		
127	728002 99611	PRESSURE REGULATING VALVE		
200	568000 27300	FRONT HOOD ATTACHMENT (KIT)		

¹⁾ necessary order quantity / maintenance

- INDICE	Pos.	No. Identification	Designation
X 4.10 DV	15	020000 50100	PISTON
	16	016800 05000	DISQUE DE SERRAGE
	17	911001 00000	BAGUE STAR
	18	949203 00000	DENT DISQUE
	19	945320 00000	VIS HEXAGONALE INTERNE
	21	000100 16200	CORP DE POMPE
	23	945319 00000	VIS HEXAGONALE INTERNE
	24	901398 00007	PALETTE DE CHARBON (KIT)
	28	000700 16200	COUVERCLE
	29	945364 00000	VIS HEXAGONALE INTERNE
	30	008901 16200	JOINT
	61	004800 27300	COUVERCLE DU FILTRE
	67	009000 16300	RESSORT-JAME
	69	952009 00000	DOVILLE DE ETRAGE
	72	909518 01000	CARTOUCHE FILTRANTE (1x)¹⁾
	74	909554 00000	CARTOUCHE FILTRANTE (1x)¹⁾
	76	945364 00000	VIS HEXAGONALE INTERNE
	77	948021 00000	JOINT
	83	006800 27300	CAPOT DE PROTECTION
	84	060901 16300	AMORTISSEUR
85	741310 50000	AMORTISSEUR EN CAOUTCHOUC	
86	949402 00000	RONDELLE	
87	947001 00000	ECROU A 6PANS	
88	006801 27400	CAPOT AVANT	
91	951922 00000	ELEMENT EN CAOUTCHOUC	
94	015100 27300	PIED	
95	951921 00000	ELEMENT EN CAOUTCHOUC	
96	068000 27600	DONILLE D'ECARMENT	
97	945363 00000	VIS HEXAGONALE INTERNE	
98	949451 00000	RONDELLE	
102	968104 00000	PIECE D'ECARTEMENT CAOUTCHOUC	
103	029600 16300	BOULON	
126	736000 99613	SOUPAPE REGLAGE VIDE	
127	728002 99611	SOUPAPE REGLAGE PRESS.	
200	568000 27300	PIÈCES DE FIXATION DU CAPOT AVANT (KIT)	

¹⁾ quantité nécessaire / entretien

- INDICE	Pos.	No. Identification	Designation
X 4.16 DV	15	020000 50200	PISTON
	16	016800 16300	DISQUE DE SERRAGE
	17	911009 00000	BAGUE STAR
	18	949203 00000	DENT DISQUE
	19	945320 00000	VIS HEXAGONALE INTERNE
	21	000105 16300	CORP DE POMPE
	23	945321 00000	VIS HEXAGONALE INTERNE
	24	901396 00007	PALETTE DE CHARBON (KIT)
	28	000705 16300	COUVERCLE
	29	945372 00000	VIS HEXAGONALE INTERNE
	30	008901 16300	JOINT
	61	004800 27400	COUVERCLE DU FILTRE
	67	009000 16300	RESSORT-JAME
	69	952009 00000	DOVILLE DE ETRAGE
	72	909519 01000	CARTOUCHE FILTRANTE (1x)¹⁾
	74	909542 00000	CARTOUCHE FILTRANTE (1x)¹⁾
	76	945325 00000	VIS HEXAGONALE INTERNE
	77	948021 00000	JOINT
	83	006800 27400	CAPOT DE PROTECTION
	84	060901 16300	AMORTISSEUR
85	741310 50000	AMORTISSEUR EN CAOUTCHOUC	
86	949402 00000	RONDELLE	
87	947001 00000	ECROU A 6PANS	
88	006801 27400	CAPOT AVANT	
91	951922 00000	ELEMENT EN CAOUTCHOUC	
94	015100 27400	PIED	
95	951921 00000	ELEMENT EN CAOUTCHOUC	
96	068000 27600	DONILLE D'ECARMENT	
97	945323 00000	VIS HEXAGONALE INTERNE	
98	949451 00000	RONDELLE	
102	968104 00000	PIECE D'ECARTEMENT CAOUTCHOUC	
103	029600 16300	BOULON	
126	736000 99613	SOUPAPE REGLAGE VIDE	
127	728002 99611	SOUPAPE REGLAGE PRESS.	
200	568000 27300	PIÈCES DE FIXATION DU CAPOT AVANT (KIT)	

¹⁾ quantité nécessaire / entretien

- INDICE	Pos.	No. Identificazione	Designazione	
X 4.10 DV	15	020000 50100	ROTORE	
	16	016800 05000	DISCO DI FISSAGGIO	
	17	911001 00000	STAR-ANELLO TOLLERANZA	
	18	949203 00000	DISCO A DENTE	
	19	945320 00000	VITE ESAGONALE INTERNA	
	21	000100 16200	CARCASSA	
	23	945319 00000	VITE ESAGONALE INTERNA	
	24	901398 00007	PALETTE DI CHARBONE (KIT)	
	28	000700 16200	COPERCHIO	
	29	945364 00000	VITE ESAGONALE INTERNA	
	30	008901 16200	GUARNIZIONE	
	61	004800 27300	COPERCHIO FILTRO	
	67	009000 16300	MOLLA	
	69	952009 00000	SPINE DI RISCONTRO	
	72	909518 01000	CARTUCCIA FILTRO (1x) ¹⁾	
	74	909554 00000	CARTUCCIA FILTRO (1x) ¹⁾	
	76	945364 00000	VITE ESAGONALE INTERNA	
	77	948021 00000	ANELLO GUARNIZIONE	
	83	006800 27300	COPERCHIO DI PROTEZIONE	
	84	060901 16300	AMORTIZZATORE	
85	741310 50000	AMMORTIZZATORE IN GOMMA		
86	949402 00000	RONDELLA		
87	947001 00000	DADO ESAGONALE		
88	006801 27400	COFANO		
91	951922 00000	ELEMENTO IN GOMMA		
94	015100 27300	PIEDE		
95	951921 00000	ELEMENTO IN GOMMA		
96	068000 27600	BOCCOLA DISTANZIATRICE		
97	945363 00000	VITE ESAGONALE INTERNA		
98	949451 00000	RONDELLA		
102	968104 00000	PEZZO DI SCOSTAM. IN GOMMA		
103	029600 16300	BULLONE		
126	736000 99613	VALVOLA REGOLAZIONE VUOTO		
127	728002 99611	VALVOLA REGOL. PRESS.		
200	568000 27300	PARTI DI FISSAGGIO DEL COFANO (KIT)		

¹⁾ quantità di ordinazione necessari / manutenzione

- INDICE	Pos.	No. Identificazione	Designazione	
X 4.16 DV	15	020000 50200	ROTORE	
	16	016800 16300	DISCO DI FISSAGGIO	
	17	911009 00000	STAR-ANELLO TOLLERANZA	
	18	949203 00000	DISCO A DENTE	
	19	945320 00000	VITE ESAGONALE INTERNA	
	21	000105 16300	CARCASSA	
	23	945321 00000	VITE ESAGONALE INTERNA	
	24	901396 00007	PALETTE DI CHARBONE (KIT)	
	28	000705 16300	COPERCHIO	
	29	945372 00000	VITE ESAGONALE INTERNA	
	30	008901 16300	GUARNIZIONE	
	61	004800 27400	COPERCHIO FILTRO	
	67	009000 16300	MOLLA	
	69	952009 00000	SPINE DI RISCONTRO	
	72	909519 01000	CARTUCCIA FILTRO (1x) ¹⁾	
	74	909542 00000	CARTUCCIA FILTRO (1x) ¹⁾	
	76	945325 00000	VITE ESAGONALE INTERNA	
	77	948021 00000	ANELLO GUARNIZIONE	
	83	006800 27400	COPERCHIO DI PROTEZIONE	
	84	060901 16300	AMORTIZZATORE	
85	741310 50000	AMMORTIZZATORE IN GOMMA		
86	949402 00000	RONDELLA		
87	947001 00000	DADO ESAGONALE		
88	006801 27400	COFANO		
91	951922 00000	ELEMENTO IN GOMMA		
94	015100 27400	PIEDE		
95	951921 00000	ELEMENTO IN GOMMA		
96	068000 27600	BOCCOLA DISTANZIATRICE		
97	945323 00000	VITE ESAGONALE INTERNA		
98	949451 00000	RONDELLA		
102	968104 00000	PEZZO DI SCOSTAM. IN GOMMA		
103	029600 16300	BULLONE		
126	736000 99613	VALVOLA REGOLAZIONE VUOTO		
127	728002 99611	VALVOLA REGOL. PRESS.		
200	568000 27300	PARTI DI FISSAGGIO DEL COFANO (KIT)		







¹⁾ quantità di ordinazione necessari / manutenzione

- ÍNDICE	Pos.	No. De pedido	Descripción	
X 4.10 DV	15	020000 50100	ÉMBOLO	
	16	016800 05000	ARANDELA TENSORA	
	17	911001 00000	ANILLO DE TOLERANCIA STAR	
	18	949203 00000	POLEA DENTADA	
	19	945320 00000	TORNILLO HEXAGONAL INTERIOR	
	21	000100 16200	CARCASA	
	23	945319 00000	TORNILLO HEXAGONAL INTERIOR	
	24	901398 00007	EMPUJADOR DE CARBÓN (KIT)	
	28	000700 16200	TAPA LATERAL	
	29	945364 00000	TORNILLO HEXAGONAL INTERIOR	
	30	008901 16200	JUNTA	
	61	004800 27300	TAPA DE FILTRO	
	67	009000 16300	MUELLE DE PRESIÓN	
	69	952009 00000	CASQUILLO TENSOR	
	72	909518 01000	CARTUCHO DE FILTRO (1x) ¹⁾	
	74	909554 00000	CARTUCHO DE FILTRO (1x) ¹⁾	
	76	945364 00000	TORNILLO HEXAGONAL INTERIOR	
	77	948021 00000	ANILLO DE JUNTA	
	83	006800 27300	CUBIERTA DEL APARATO	
	84	060901 16300	TIRAS DE AMORTIGUACIÓN	
85	741310 50000	AMORTIGUADOR DE GOMA		
86	949402 00000	ARANDELA		
87	947001 00000	TUERCA HEXAGONAL		
88	006801 27400	CUBIERTA FRONTAL		
91	951922 00000	PIEZA DE ORMA DE GOMA		
94	015100 27300	PIE DE MOTOR		
95	951921 00000	PIEZA DE ORMA DE GOMA		
96	068000 27600	PIEZA DISTANCIADORA		
97	945363 00000	TORNILLO HEXAGONAL INTERIOR		
98	949451 00000	ARANDELA		
102	968104 00000	PIEZA DE GOMA DISTANCIADORA		
103	029600 16300	BULÓN		
126	736000 99613	VÁLVULA REGULADORA DE VACÍO		
127	728002 99611	VÁLVULA REGULADORA DE PRESIÓN		
200	568000 27300	PIEZAS DE FIJACIÓN DE LA CUBIERTA FRONTAL (KIT)		

¹⁾ cantidad necesario / mantenimiento

- ÍNDICE	Pos.	No. De pedido	Descripción	
X 4.16 DV	15	020000 50200	ÉMBOLO	
	16	016800 16300	ARANDELA TENSORA	
	17	911009 00000	ANILLO DE TOLERANCIA STAR	
	18	949203 00000	POLEA DENTADA	
	19	945320 00000	TORNILLO HEXAGONAL INTERIOR	
	21	000105 16300	CARCASA	
	23	945321 00000	TORNILLO HEXAGONAL INTERIOR	
	24	901396 00007	EMPUJADOR DE CARBÓN (KIT)	
	28	000705 16300	TAPA LATERAL	
	29	945372 00000	TORNILLO HEXAGONAL INTERIOR	
	30	008901 16300	JUNTA	
	61	004800 27400	TAPA DE FILTRO	
	67	009000 16300	MUELLE DE PRESIÓN	
	69	952009 00000	CASQUILLO TENSOR	
	72	909519 01000	CARTUCHO DE FILTRO (1x) ¹⁾	
	74	909542 00000	CARTUCHO-"C"-SEPARADOR (1x) ¹⁾	
	76	945325 00000	TORNILLO HEXAGONAL INTERIOR	
	77	948021 00000	ANILLO DE JUNTA	
	83	006800 27400	CUBIERTA DEL APARATO	
	84	060901 16300	TIRAS DE AMORTIGUACIÓN	
85	741310 50000	AMORTIGUADOR DE GOMA		
86	949402 00000	ARANDELA		
87	947001 00000	TUERCA HEXAGONAL		
88	006801 27400	CUBIERTA FRONTAL		
91	951922 00000	PIEZA DE ORMA DE GOMA		
94	015100 27400	PIE DE MOTOR		
95	951921 00000	PIEZA DE ORMA DE GOMA		
96	068000 27600	PIEZA DISTANCIADORA		
97	945323 00000	TORNILLO HEXAGONAL INTERIOR		
98	949451 00000	ARANDELA		
102	968104 00000	PIEZA DE GOMA DISTANCIADORA		
103	029600 16300	BULÓN		
126	736000 99613	VÁLVULA REGULADORA DE VACÍO		
127	728002 99611	VÁLVULA REGULADORA DE PRESIÓN		
200	568000 27300	PIEZAS DE FIJACIÓN DE LA CUBIERTA FRONTAL (KIT)		

¹⁾ cantidad necesario / mantenimiento

X 4.10 DV X 4.16 DV	Variante 	Pos. ²⁾	Bestell Nr. / Ident No. / No. Identification / No. Identificazione / No. De pedido		Beschreibung / Description / Designation / Designazione / Descripcion
			  	  	
X 4.10 DV					
① 1~ Einphasenwechselstrom 1~ single-phase AC 1~ AC monophasé 1~ AC monofase 1~ AC monofásica		5	964233 00000		WINKEL / BRACKET / SUPPORT / SUPPORTO / SOPORTE
		6	945204 00000		SECHSKANTSCHRAUBE / HEX-HEAD SCREW / VIS HEXAGONALE / VITE ESAGONALE / TORNILLO DE CABEZA HEXAGONAL
		7	947102 00000		MUTTER / NUT / ECROU / DADO / TUERCA
		8	742002 40000		KABEL / CABLE / CABLE / CAVO / CABLE
		83	006802 27300	006800 27300	HAUBE / PROTECTING HOOD / CARTER PROTECTEUR / CARTER DI PROTEZIONE / CAPERUZA
X 4.16 DV					
② 1~ Einphasenwechselstrom 1~ single-phase AC 1~ AC monophasé 1~ AC monofase 1~ AC monofásica		5	964233 00000		WINKEL / BRACKET / SUPPORT / SUPPORTO / SOPORTE
		6	945204 00000		SECHSKANTSCHRAUBE / HEX-HEAD SCREW / VIS HEXAGONALE / VITE ESAGONALE / TORNILLO DE CABEZA HEXAGONAL
		7	947102 00000		MUTTER / NUT / ECROU / DADO / TUERCA
		8	742002 40000		KABEL / CABLE / CABLE / CAVO / CABLE
		83	006802 27400	006800 27400	HAUBE / PROTECTING HOOD / CARTER PROTECTEUR / CARTER DI PROTEZIONE / CAPERUZA

²⁾ variantenabhängige Bauteile / variant-dependent components / composants variante-dependantes / componenti variante-dispendenti / componentes variante-dependientes