

**SV 5.690/1**  
**SV 5.690/2**

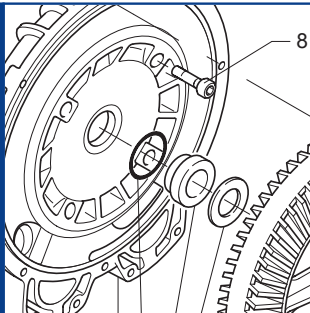

**SERVICE**

**BECKER**  
D-42279 Wuppertal  
www.becker-international.com

No. **A** year XXXX

type **SV 5.690-XX** Index Variante

frequency	XXXX	Hz
speed	XXXX	min <sup>-1</sup>
power required	XXXX	kW
inlet capacity	XXXX	m <sup>3</sup> /h
pressure +	XXXX	mbar
vacuum -	XXXX	mbar

Made in Germany

Ersatzteilliste  
Spare parts list  
Liste de pièces de rechange  
Listino pezzi di ricambio  
Lista de piezas de recambio  
Lista de peças sobresselentes  
Reserveonderdelenlijst  
Atsarginių dalių sąrašas  
Varuosad nimekirja  
Rezerves daļu saraksts

Reservedelsliste  
Reservdelslista  
Varaosaluettelo  
Reservedelsliste  
Wykaz części zamiennych  
Tartalékalkatrész lista  
Seznam náhradních dílů  
Seznam nadomestnih delov  
Zoznam náhradných dielov  
Rezervni dijelovi popis

Lista pieselor de schimb  
Páirteanna spártha liosta  
Κατάλογος ανταλλακτικών  
Yedek parça listesi  
Списък на резервните части  
Перечень запасных частей  
スペアパーツリスト  
예비 부품 목록  
备用零件目录

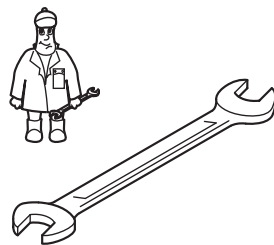

Wartung  
Maintenance  
Entretien  
Manutenzione  
Mantenimiento



SV 5.690/1 Standard  
SV 5.690/2



Variante



SV 5.690/1-XX

① /1-30  
ohne Schalldämpfer  
without silencer  
sans silencieux  
senza silenziatore  
sin silenciador

② /1-48  
Sonderausführung  
Special design  
Fabrication spéciale  
Modello speciale  
Versión especial

③ /2-510  
Sonderausführung  
Special design  
Fabrication spéciale  
Modello speciale  
Versión especial

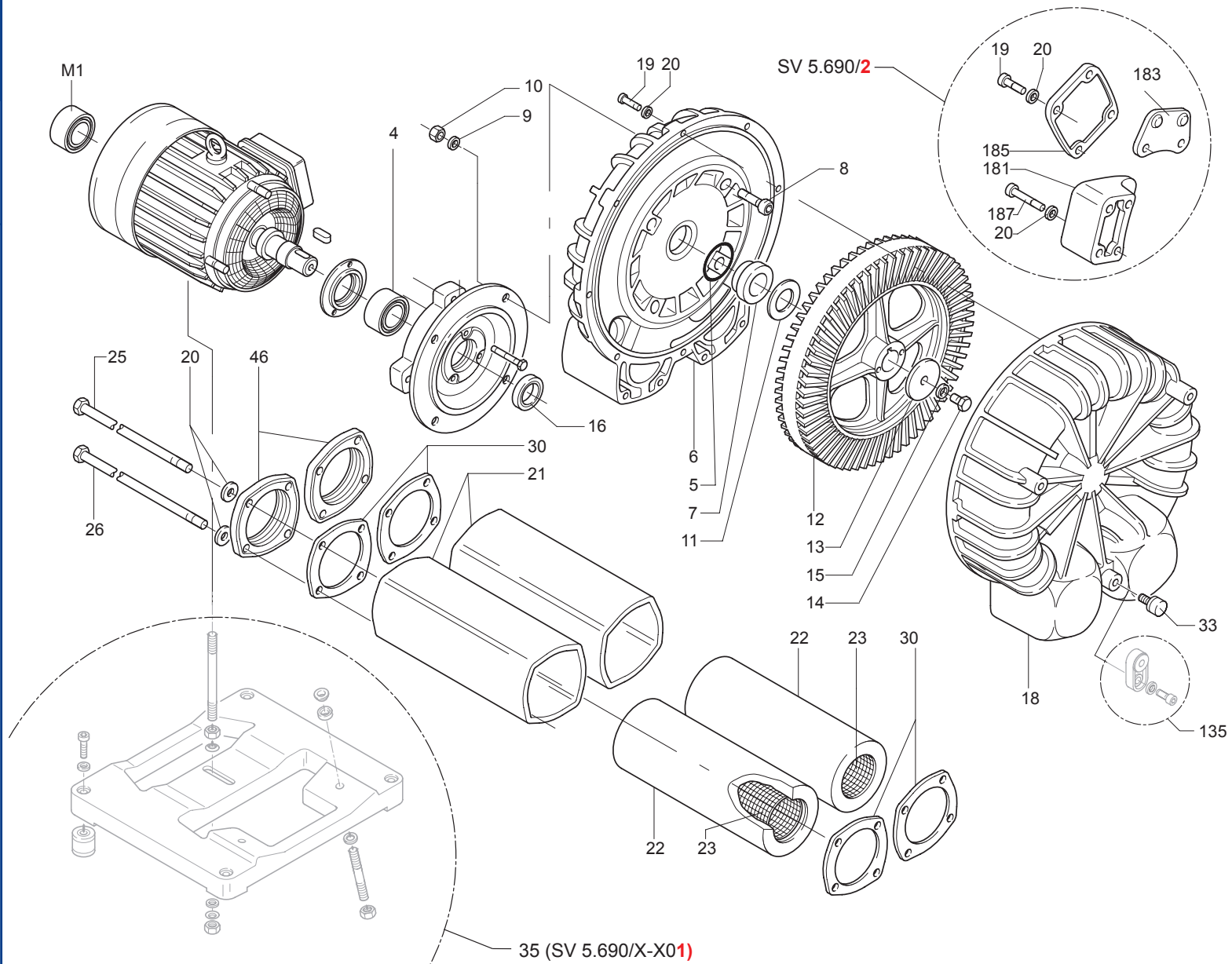

SERVICE ?

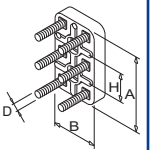
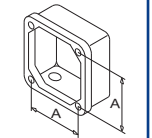
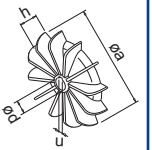
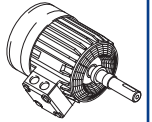

- INDEX	Pos.	Bestell Nr.	Beschreibung	
SV 5.690	4	906611 10000	WÄZLAGER 3208 2 RS C3 TA	
	5	911317 00000	DICHTUNGSSCHLAUCH	
	6	000102 16800	GEHÄUSE (SV5.690/1)	
	6	000103 16800	GEHÄUSE (SV5.690/2)	
	7	013901 16900	DISTANZBUCHSE	
	8	945361 00000	INNENSECHSKANTSCHRAUBE	
	9	951705 00000	FEDERSCHEIBE	
	10	947111 10000	SECHSKANTMÜTTER	
	11	511400 16600	SATZ DISTANZSCHEIBEN	
	12	000600 16900	LAUFRAD	
	13	016800 16900	SPANNSCHEIBE	
	14	945243 00000	SECHSKANTSCHRAUBE	
	15	948516 00000	FEDERING	
	16	906578 00000	WELLENDICHRING	
	18	000200 16800	GEHÄUSEDECKEL (SV5.690/1)	
	18	000203 16800	GEHÄUSEDECKEL (SV5.690/2)	
	19	945323 00000	INNENSECHSKANTSCHRAUBE	
	20	951703 00000	FEDERSCHEIBE	
	21	007420 16900	SCHALLDÄMPFERGEHÄUSE	
	22	007700 16900	DÄMPFER	
23	907610 16900	SIEBROHR		
25	003801 16900	ZUGANKERSCHRAUBE		
26	003803 16800	ZUGANKERSCHRAUBE		
30	007500 16900	DICHTUNG		
33	741310 10000	GUMMIPUFFER		
35	515103 16800	GERÄTEFUSS, KOMPL. / BG112 <sup>1)</sup>		
35	515100 16800	GERÄTEFUSS, KOMPL. / BG132 <sup>1)</sup>		
35	515101 16800	GERÄTEFUSS, KOMPL. / BG160 <sup>1)</sup>		
46	007800 16901	ANSCHLUSSFLANSCH		
135	515102 16800	FUSS, (3x) <sup>1)</sup>		
181	015500 16800	REDUZIERSTÜCK (SV5.690/2)		
183	005601 16800	DECKEL (SV5.690/2)		
185	005600 16800	DECKEL (SV5.690/2)		
187	945374 00000	INNENSECHSKANTSCHRAUBE (SV5.690/2)		
M1	906639 00000	MOTORLAGER 6306 <sup>2)</sup>		
M1	906635 00000	MOTORLAGER 6308 <sup>2)</sup>		
M1	906616 40000	MOTORLAGER 6208 <sup>2)</sup>		
M1	906615 50000	MOTORLAGER 6309 <sup>2)</sup>		
M1	906615 70000	MOTORLAGER 6310 <sup>2)</sup>		

<sup>1)</sup> optional

<sup>2)</sup> motorabhängig / Lager sind mit Spezialfett gefüllt. Nur durch Original der Firma Gebr. Becker ersetzen.

- INDEX	Pos.	Ident No.	Description	
SV 5.690	4	906611 10000	BALL BEARING 3208 2 RS C3 TA	
	5	911317 00000	SEAL	
	6	000102 16800	PUMP BODY (SV5.690/1)	
	6	000103 16800	PUMP BODY (SV5.690/2)	
	7	013901 16900	SPACER	
	8	945361 00000	SOCKET HEAD SCREW	
	9	951705 00000	SPRING DISC	
	10	947111 10000	HEX. NUT	
	11	511400 16600	SET DISTANCE DISC	
	12	000600 16900	IMPELLER	
	13	016800 16900	CLAMPING DISC	
	14	945243 00000	HEX-HEAD SCREW	
	15	948516 00000	SPRING WASHER	
	16	906578 00000	SHAFT-SEALING RING	
	18	000200 16800	HOUSING LID (SV5.690/1)	
	18	000203 16800	HOUSING LID (SV5.690/2)	
	19	945323 00000	SOCKET HEAD SCREW	
	20	951703 00000	LOCKING WASHER	
	21	007420 16900	SILENCER HOUSING	
	22	007700 16900	SILENCER SPONGE	
23	907610 16900	STRAINER TUBE		
25	003801 16900	ANCHORING SCREW		
26	003803 16800	ANCHORING SCREW		
30	007500 16900	GASKET		
33	741310 10000	RUBBER BUFFER		
35	515103 16800	FOOT, COMPL. / BG11 <sup>1)</sup>		
35	515100 16800	FOOT, COMPL. / BG132 <sup>1)</sup>		
35	515101 16800	FOOT, COMPL. / BG160 <sup>1)</sup>		
46	007800 16901	CONNECTING FLANGE		
135	515102 16800	FOOT, (3x) <sup>1)</sup>		
181	015500 16800	REDUCING PIECE (SV5.690/2)		
183	005601 16800	CAP (SV5.690/2)		
185	005600 16800	CAP (SV5.690/2)		
187	945374 00000	SOCKET HEAD SCREW (SV5.690/2)		
M1	906639 00000	BALL BEARING 6306 <sup>2)</sup>		
M1	906635 00000	BALL BEARING 6308 <sup>2)</sup>		
M1	906616 40000	BALL BEARING 6208 <sup>2)</sup>		
M1	906615 50000	BALL BEARING 6309 <sup>2)</sup>		
M1	906615 70000	BALL BEARING 6310 <sup>2)</sup>		

<sup>1)</sup> optional

<sup>2)</sup> motor-dependent / Bearings are filled with special grease. Only be replaced by Gebrüder Beckers original.

- INDEX	Pos.	No. Identification	Designation		
SV 5.690	4	906611 10000	ROULEMENT A BILLES 3208 2 RS C3 TA		
	5	911317 00000	JOINT		
	6	000102 16800	CORP DE POMPE (SV5.690/1)		
	6	000103 16800	CORP DE POMPE (SV5.690/2)		
	7	013901 16900	DOUILLE		
	8	945361 00000	VIS HEXAGONALE INTERNE		
	9	951705 00000	DISQUE DE RESSORT		
	10	947111 10000	ECROU A 6 PANS		
	11	511400 16600	JEU DISQUE DE TOLERANCE		
	12	000600 16900	ROUE		
	13	016800 16900	DISQUE DE SERRAGE		
	14	945243 00000	VIS HEXAGONALE		
	15	948516 00000	ANNEAU-RESSORT		
	16	906578 00000	BAGUE D'ETANCHEITE P.L'AXE		
	18	000200 16800	COUVERCLE (SV5.690/1)		
	18	000203 16800	COUVERCLE (SV5.690/2)		
	19	945323 00000	VIS HEXAGONALE INTERNE		
	20	951703 00000	RONDELLE À RESSORT		
	21	007420 16900	CARCASSE SILENCIEUX		
	22	007700 16900	MOUSSE POUR SILENCIEUX		
	23	907610 16900	GRILLE POUR SILENCIEUX		
	25	003801 16900	VIS D'ANCRAGE		
	26	003803 16800	VIS D'ANCRAGE		
	30	007500 16900	JOINT		
	33	741310 10000	AMORTISSEUR EN CAOUTCHOUC		
	35	515103 16800	PIED, COMPL. / BG112 <sup>1)</sup>		
	35	515100 16800	PIED, COMPL. / BG132 <sup>1)</sup>		
	35	515101 16800	PIED, COMPL. / BG160 <sup>1)</sup>		
	46	007800 16901	BRIDE DE RACCORDEMENT		
	135	515102 16800	PIED, (3x) <sup>1)</sup>		
181	015500 16800	PIECE DE REDUCTION (SV5.690/2)			
183	005601 16800	COUVERCLE (SV5.690/2)			
185	005600 16800	COUVERCLE (SV5.690/2)			
187	945374 00000	VIS HEXAGONALE INTERNE (SV5.690/2)			
M1	906639 00000	ROULEMENT A BILLES 6306 <sup>2)</sup>			
M1	906635 00000	ROULEMENT A BILLES 6308 <sup>2)</sup>			
M1	906616 40000	ROULEMENT A BILLES 6208 <sup>2)</sup>			
M1	906615 50000	ROULEMENT A BILLES 6309 <sup>2)</sup>			
M1	906615 70000	ROULEMENT A BILLES 6310 <sup>2)</sup>			

<sup>1)</sup> en option

<sup>2)</sup> dépendant du moteur / Les roulements sont remis d'une graisse spéciale. N'utiliser que de la graisse d'origine de Gebrüder Becker.

- INDEX	Pos.	No. Identificazione	Designazione		
SV 5.690	4	906611 10000	CUSCINETTO A SFERA 3208 2 RS C3 TA		
	5	911317 00000	GUARNIZIONE		
	6	000102 16800	CARCASSA (SV5.690/1)		
	6	000103 16800	CARCASSA (SV5.690/2)		
	7	013901 16900	BOCCOLA		
	8	945361 00000	VITE ESAGONALE INTERNA		
	9	951705 00000	DISCO A MOLLA		
	10	947111 10000	DADO ESAGONALE		
	11	511400 16600	SERIE DISCO GIUOCO		
	12	000600 16900	GIRANTE		
	13	016800 16900	DISCO DI FISSAGGIO		
	14	945243 00000	VITE ESAGONALE		
	15	948516 00000	ANELLO A MOLLA		
	16	906578 00000	GUARNIZIONE PER L'ALBERO		
	18	000200 16800	COPERCHIO (SV5.690/1)		
	18	000203 16800	COPERCHIO (SV5.690/2)		
	19	945323 00000	VITE ESAGONALE INTERNA		
	20	951703 00000	DISCO A MOLLA		
	21	007420 16900	CARCASSA SILENZIATORE		
	22	007700 16900	MATERIALE PER SILENZIATORE		
	23	907610 16900	TUBO-CRIVELLO		
	25	003801 16900	CHIAVARDA D'ANCORAGGIO		
	26	003803 16800	CHIAVARDA D'ANCORAGGIO		
	30	007500 16900	GUARNIZIONE		
	33	741310 10000	AMMORTIZZATORE IN GOMMA		
	35	515103 16800	PIASTRA DI APPOGGIO, COMPL. / BG112 <sup>1)</sup>		
	35	515100 16800	PIASTRA DI APPOGGIO, COMPL. / BG132 <sup>1)</sup>		
	35	515101 16800	PIASTRA DI APPOGGIO, COMPL. / BG160 <sup>1)</sup>		
	46	007800 16901	FLANGIA DI RACCORDO		
	135	515102 16800	PIASTRA, (3x) <sup>1)</sup>		
181	015500 16800	GIUNTO DI REDUZIONE (SV5.690/2)			
183	005601 16800	COPERCHIO (SV5.690/2)			
185	005600 16800	COPERCHIO (SV5.690/2)			
187	945374 00000	VITE ESAGONALE INTERNA (SV5.690/2)			
M1	906639 00000	CUSCINETTO A SFERA 6306 <sup>2)</sup>			
M1	906635 00000	CUSCINETTO A SFERA 6308 <sup>2)</sup>			
M1	906616 40000	CUSCINETTO A SFERA 6208 <sup>2)</sup>			
M1	906615 50000	CUSCINETTO A SFERA 6309 <sup>2)</sup>			
M1	906615 70000	CUSCINETTO A SFERA 6310 <sup>2)</sup>			







<sup>1)</sup> optionale

<sup>2)</sup> dipende del motore / I cuscinetti sono riempiti di grasso speciale. Eseguire il reingrassaggio solo con grasso originale della Gebrüder Becker.

INDICE	Pos.	No. De pedido	Descripción	
<b>SV 5.690</b>	4	906611 10000	COJINETE DE RODAMIENTO 3208 2 RS C3 TA	
	5	911317 00000	MANGUERA DE JUNTA	
	6	000102 16800	CARCASA (SV5.690/1)	
	6	000103 16800	CARCASA (SV5.690/2)	
	7	013901 16900	CASQUILLO DISTANCIADOR	
	8	945361 00000	TORNILLO HEXAGONAL INTERIOR	
	9	951705 00000	ARANDELA ELÁSTICA	
	10	947111 10000	TUERCA HEXAGONAL	
	11	511400 16600	JUEGO DE ARANDELAS DISTANCIADORAS	
	12	000600 16900	RUEDA CORREDERA	
	13	016800 16900	ARANDELA TENSORA	
	14	945243 00000	TORNILLO DE CABEZA HEXAGONAL	
	15	948516 00000	ARANDELA DE MUELLE	
	16	906578 00000	ANILLO DE JUNTA DE ÁRBOL	
	18	000200 16800	TAPA DE CARCASA (SV5.690/1)	
	18	000203 16800	TAPA DE CARCASA (SV5.690/2)	
	19	945323 00000	TORNILLO HEXAGONAL INTERIOR	
	20	951703 00000	ARANDELA ELÁSTICA	
	21	007420 16900	CARCASA DE SILENCIADOR	
	22	007700 16900	AMORTIGUADOR	
	23	907610 16900	TUBO DE CRIBA	
	25	003801 16900	TORNILLO DE ANCLAJE	
	26	003803 16800	TORNILLO DE ANCLAJE	
	30	007500 16900	JUNTA	
	33	741310 10000	AMORTIGUADOR DE GOMA	
	35	515103 16800	PIE DE APARATO, COMPL. / BG112 <sup>1)</sup>	
	35	515100 16800	PIE DE APARATO, COMPL. / BG132 <sup>1)</sup>	
	35	515101 16800	PIE DE APARATO, COMPL. / BG160 <sup>1)</sup>	
	46	007800 16901	BRIDA DE EMPALME	
	135	515102 16800	PIE, (3x) <sup>1)</sup>	
181	015500 16800	PIEZA DE REDUCCIÓN (SV5.690/2)		
183	005601 16800	TAPA (SV5.690/2)		
185	005600 16800	TAPA (SV5.690/2)		
187	945374 00000	TORNILLO HEXAGONAL INTERIOR (SV5.690/2)		
M1	906639 00000	COJINETE DE RODAMIENTO 6306 <sup>2)</sup>		
M1	906635 00000	COJINETE DE RODAMIENTO 6308 <sup>2)</sup>		
M1	906616 40000	COJINETE DE RODAMIENTO 6208 <sup>2)</sup>		
M1	906615 50000	COJINETE DE RODAMIENTO 6309 <sup>2)</sup>		
M1	906615 70000	COJINETE DE RODAMIENTO 6310 <sup>2)</sup>		

<sup>1)</sup> opcional

<sup>2)</sup> dependiente del motor / Los rodamientos estan rellenos de grasa especial. Sólo reemplazar por grasa original de Gebrüder Becker.

SV5.690/1-XX SV5.690/2-XX	Variante 	Pos. <sup>2)</sup>	Bestell Nr. / Ident No. / No. Identification / No. Identificazione / No. De pedido		Beschreibung / Description / Designation / Designazione / Desripcion
			  	  	
① /1-30 ohne Schalldämpfer without silencer sans silencieux senza silenziatore sin silenciador		12	000602 16900	<del>000600 16900</del>	LAUFRAD / IMPELLER / ROUE / GIRANTE / RUEDA CORREDERA
		21		<del>007420 16900</del>	SCHALLDÄMPFERGEHÄUSE / SILENCER HOUSING / CARCASSE SILENCIEUX / CARCASSA SILENZIATORE / CARCASA DE SILENCIADOR
		22		<del>007700 16900</del>	DÄMPFER / SILENCER SPONGE / MOUSSE POUR SILENCIEUX / MATERIALE PER SILENZIATORE / AMORTIGUADOR
		23		<del>007610 16900</del>	SIEBROHR / STRAINER TUBE / GRILLE POUR SILENCIEUX / TUBO-CRIVELLO / TUBO DE CRIBA
		25		<del>003801 16900</del>	ZUGANKERSCHRAUBE / ANCHORING SCREW / VIS D'ANCRAGE / CHIAVARDA D'ANCORAGGIO / TORNILLO DE ANCLAJE
		26		<del>003803 16800</del>	ZUGANKERSCHRAUBE / ANCHORING SCREW / VIS D'ANCRAGE / CHIAVARDA D'ANCORAGGIO / TORNILLO DE ANCLAJE
		27		<del>954703 00000</del>	FEDERSCHEIBE / LOCKING WASHER / RONDELLE À RESSORT / DISCO A MOLLA / ARANDELA ELÁSTICA
		30		<del>007500 16900</del>	DICHTUNG / GASKET / JOINT / GUARNIZIONE / JUNTA
		33		<del>741310 10000</del>	GUMMIPUFFER / RUBBER BUFFER / AMORTISSEUR EN CAOUTCHOUC / AMMORTIZZATORE IN GOMMA / AMORTIGUADOR DE GOMA
		46		<del>007800 16900</del>	ANSCHLUSSFLANSCH / CONNECTING FLANGE / BRIDE DE RACCORDEMENT / FLANGIA DI RACCORDO / BRIDA DE EMPALME
		50	062900 16900		ABDECKUNG / COVERING / REVÊTEMENT / RIVESTIMENTO / RECUBRIMIENTO
	54	945320 00000		INNENSECHSKANTSCHRAUBE / SOCKET HEAD SCREW / VIS HEXAGONALE INTERNE / VITE ESAGONALE INTERNA / TORNILLO HEXAGONAL INTERIOR	
② /1-48 Sonderausführung Special design Fabrication spéciale Modello speciale Versión especial		12	000601 16900	<del>000600 16900</del>	LAUFRAD / IMPELLER / ROUE / GIRANTE / RUEDA CORREDERA
③ /2-510 Sonderausführung Special design Fabrication spéciale Modello speciale Versión especial		21	007405 16900	<del>007420 16900</del>	1x SCHALLDÄMPFERGEHÄUSE / 1x SILENCER HOUSING / 1x CARCASSE SILENCIEUX / 1x CARCASSA SILENZIATORE / 1x CARCASA DE SILENCIADOR
		22	907702 00000	<del>007700 16900</del>	DÄMPFER / SILENCER SPONGE / MOUSSE POUR SILENCIEUX / MATERIALE PER SILENZIATORE / AMORTIGUADOR
		23	907600 30000 + 007602 57000	<del>007610 16900</del>	SIEBROHR / STRAINER TUBE / GRILLE POUR SILENCIEUX / TUBO-CRIVELLO / TUBO DE CRIBA

<sup>2)</sup> variantenabhängige Bauteile / variant-dependent components / composants variante-dependantes / componenti variante-dispendenti / componentes variante-dependientes