

U 4.100

Ersatzteilliste
 Spare parts list
 Liste de pièces de rechange
 Listino pezzi di ricambio
 Lista de piezas de recambio
 Reserveonderdelenlijst
 Reservdelistsite
 Reservdelistsita

Reservdelistsite
 Varaosaluettelo
 Wykaz części zamiennych
 Seznam náhradních dílů
 Tartalékalkatrész lista
 Κατάλογος ανταλλακτικών
 Yedek parça listesi
 Перечень запасных частей
 备用零件目录
 スペアパーツリスト

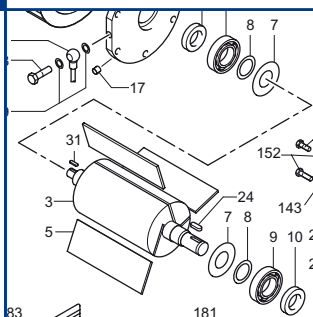

SERVICE

BECKER
D-42279 Wuppertal
www.becker-international.com

year

No. **H**

type **U 4.100-XX**

frequency Hz

speed min⁻¹

power required kW

inlet capacity m³/h

pressure + mbar

vacuum - mbar

Made in Germany

Index Variante

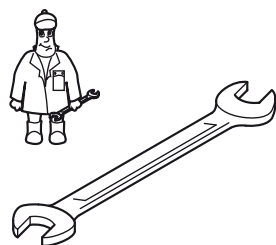
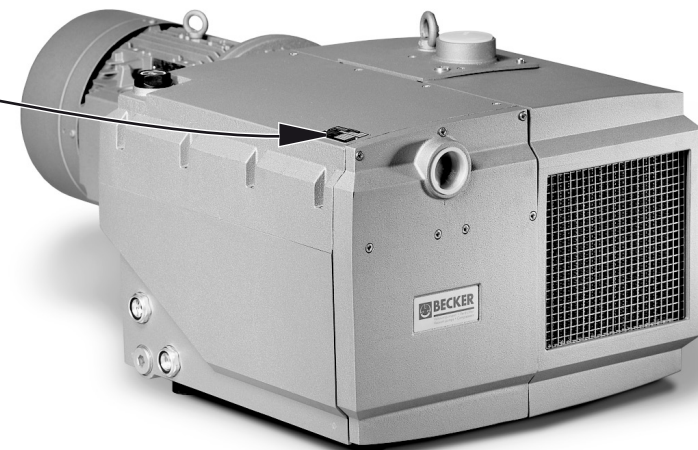

Pos.	Menge ²⁾ Quantity Quantité Quantità Cantidad	Bestell-Nr. Ident No. No. Identification No. Identificazione No. de pedido	Bezeichnung Description Designation Designazione Descripción
□	1	549000 26100	Dichtungssatz, Complete set of seals, Jeu de joints, Kit di guarnizioni, Junta Completa
5	SATZ/KIT	900512 00003	Schieber, Rotor Vane, Palette, Empujador
83	1	965416 00000	Luftentölelement, Oil separating element, Element separation huile, Cartuccia sepa-ratore olio, Elemento de desaceitar de aire

²⁾ erforderliche Bestellmenge / necessary order quantity / quantité nécessaire / quantità di ordinazione necessari / cantidad necesario

Wartung
Maintenance
Entretien
Manutenzione
Mantenimiento



U 4.100

Standard



Variante





U 4.100/XX

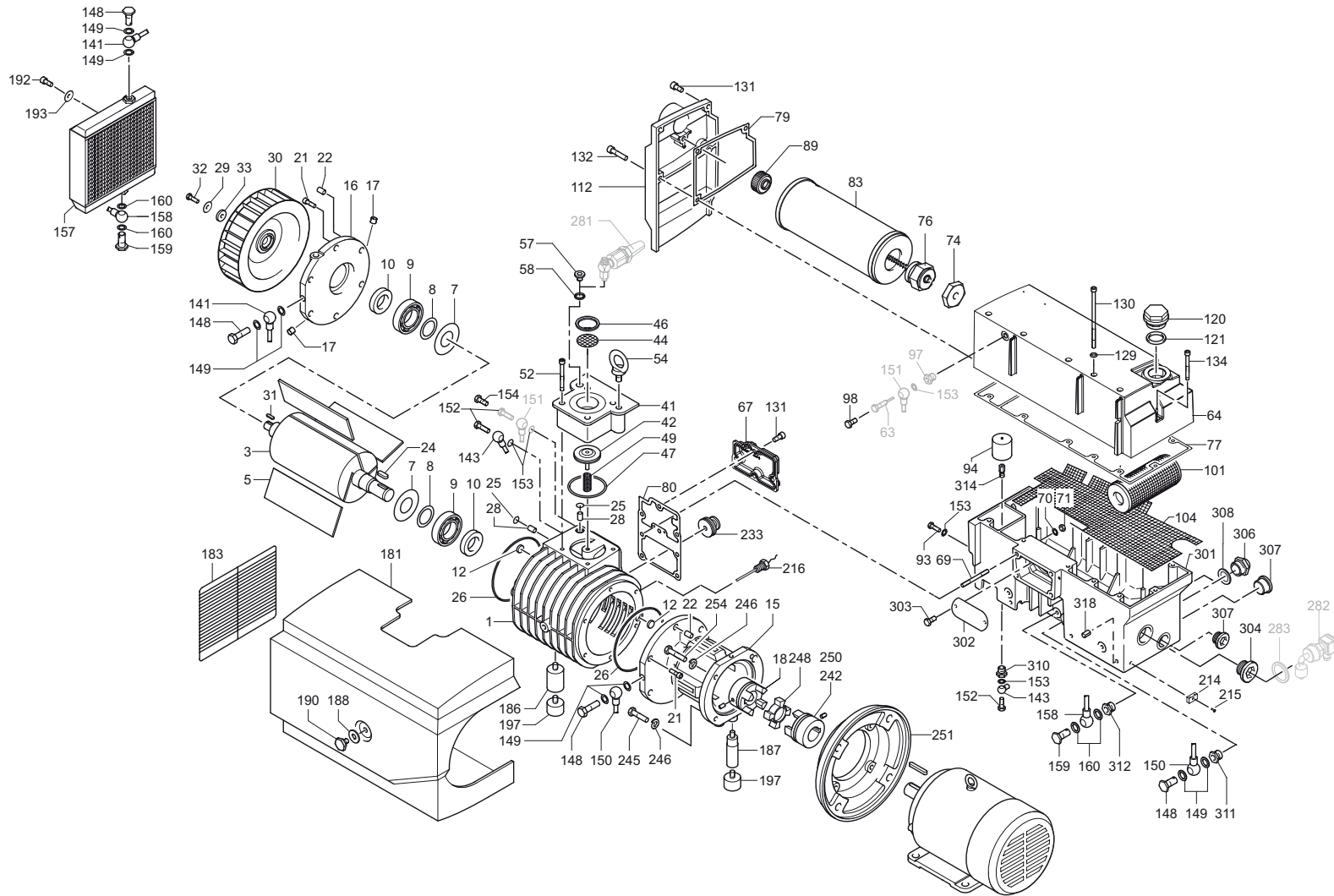

- ① U 4.100 F/K
- ②③ U 4.100 SA/K-25 + F/K-25
- ④⑤ U 4.100 SA/K-51 + F/K-51
- ⑥ U 4.100 SA/K-54
- ⑦⑧ U 4.100 SA/K-58 + F/K-58

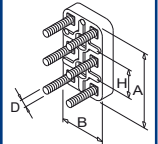
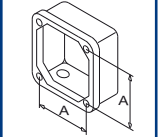
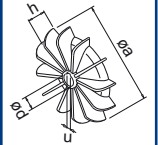
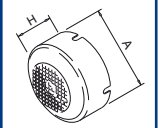
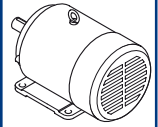

SERVICE ?



H INDEX	Pos.	Bestell Nr.	Beschreibung	
U 4.100	□	549000 26100	DICHTUNGSSATZ ¹⁾	
	1	000103 26200	GEHÄUSE	
	3	020000 26200	KOLBEN	
	5	900512 00003	SCHIEBER (SATZ) ²⁾	
	7	917609 00000	LAGERDICHTRING	
	8	917501 00000	PASS-SCHEIBE	
	9	906622 00000	WÄLZLAGER	
	10	906528 00000	WELLENDICHTRING	
	12	912820 00000	VERSCHLUSSDECKEL	
	15	000801 26200	SEITENDECKEL	
	16	000701 26200	SEITENDECKEL	
	17	912871 00000	VERSCHLUSS-SCHRAUBE	
	18	902000 10600	GEBLÄSEKUPPLUNG	
	21	945320 00000	INNENSECHSKANTSCHRAUBE	
	22	948742 00000	PASSKERBSTIFT	
	24	947732 00000	PASSFEDER	
	28	952008 00000	SPANNHÜLSE	
	29	951705 00000	FEDERSCHEIBE	
	30	902300 26200	VENTILATOR MIT NABE	
31	947713 00000	PASSFEDER		
32	901808 00000	WELLENENDSCHRAUBE		
33	947507 00000	UNTERLEGSCHLEIFE		
41	007801 26200	GEWINDEFLENSCH		
42	533900 26200	VENTILPLATTE, KOMPLETT		
44	005000 26200	SIEB		
46	948219 02000	SEEGER-RING		
49	928602 60000	DRUCKFEDER		
52	945325 00000	INNENSECHSKANTSCHRAUBE		
54	948802 00000	RINGSCHRAUBE		
57	951228 02000	VERSCHLUSS-SCHRAUBE		
64	001703 26200	ÖLBEHÄLTERDECKEL		
67	003704 26200	DECKEL		
69	951005 02000	STIFTSCHRAUBE		
70	917113 00000	TELLERFEDER		
71	947104 00000	SECHSKANTMUTTER		
74	305800 02000	ÜBERWURFMUTTER		
76	727506 99628	ABBLASEVENTIL		
83	965416 00000	LUFTENTÖLELEMENT (1x) ²⁾		
89	921500 50000	HANDGRIFF		
93	945226 00000	SECHSKANTSCHRAUBE		
94	867800 99559	SCHWIMMER		
98	912871 00000	VERSCHLUSS-SCHRAUBE		
101	506000 26200	GROBABSCHIEDER KOMPLETT		
104	008001 26200	FILTERBLECH		
112	003703 26200	DECKEL		
120	916800 10000	SCHRAUBDECKEL		
130	945387 00000	INNENSECHSKANTSCHRAUBE		
131	945319 00000	INNENSECHSKANTSCHRAUBE		
132	945323 00000	INNENSECHSKANTSCHRAUBE		
134	945324 00000	INNENSECHSKANTSCHRAUBE		
141	012211 26200	LEITUNG		
143	012218 26200	LEITUNG		
148	948401 00000	HOHLSCHRAUBE		
150	012209 26200	LEITUNG		
152	009400 19000	KUGELSTÜCKSCHRAUBE		
154	012900 19000	VERSCHLUSS-SCHRAUBE		
157	960202 26200	KÜHLER		
158	012210 26200	LEITUNG		
159	948402 00000	HOHLSCHRAUBE		

H INDEX	Pos.	Bestell Nr.	Beschreibung	
	181	018302 26200	ABDECKHAUBE	
	183	922400 60000	SCHUTZGITTER	
	186	568001 10700	ZWISCHENSTÜCK	
	187	568100 10700	STÜTZE KOMPL.	
	188	949408 00000	U-SCHLEIFE	
	190	945227 00000	WELLENABSCHLUSSSCHRAUBE	
	192	901809 00000	SCHRAUBE	
	193	949451 00000	U-SCHLEIFE	
	197	741310 60000	GUMMIPUFFER	
	214	950700 10000	LÜSTERKLEMMLE	
	215	946304 00000	SCHRAUBE	
	216	943400 90000	TEMPERATURFÜHLER	
	242	902101 10600	MOTORKUPPLUNGSHÄLFTE Ø28MM	
	245	945117 00000	SECHSKANTSCHRAUBE	
	246	948507 00000	FEDERRING	
	248	902200 10600	KUPPLUNGSRING	
	250	902100 26100	MOTORKUPPLUNG (US)	
	251	037900 26200	ZWISCHENFLANSCH (US)	
	254	945232 00000	SECHSKANTSCHRAUBE (US)	
	281	768706 99626	GASBALLASTVENTIL - OPTIONAL	
	282	741103 99682	NIVEAUGEBER - OPTIONAL	
	283	948086 00000	DICHTUNG	
	301	002407 26200	ÖLBEHÄLTER	
	302	013301 26200	PRALLBLECH	
	303	945211 00000	SECHSKANTSCHRAUBE	
	304	951221 00100	VERSCHLUSS-SCHRAUBE	
	306	907309 00000	ÖLSCHAUGLAS	
	307	951220 00100	VERSCHLUSS-SSCHRAUBE	
	310	912300 00000	ANSCHLUSS-SCHRAUBE	
	311	912305 00000	ANSCHLUSS-SCHRAUBE	
	312	912306 00000	ANSCHLUSS-SCHRAUBE	
	314	003300 10700	DÜSE	
	318	952005 00000	SPANNHÜLSE	
		960009 00000	BECKER LUBE M 100 (MINERALÖL) - 1L	
		960016 00100	BECKER LUBE S 100 (SYNTHETIKÖL) - 1L	
		960023 00100	BECKER LUBE SL 100 (LEBENSMITTELBEREICH) - 1L	

¹⁾ Dichtungssatz - 549000 26100 - Pos.: 25, 26, 47, 58, 77, 79, 80, 121, 129, 149, 153, 160, 283, 308, 319
²⁾ erforderliche Bestellmenge / Wartung

H INDEX	Pos.	Ident No.	Description	
U 4.100	□	549000 26100	SET OF SEALS ¹⁾	
	1	000103 26200	PUMP BODY	
	3	020000 26200	ROTOR	
	5	900512 00003	ROTOR VANE IN PLASTIC (KIT) ²⁾	
	7	917609 00000	GASKET	
	8	917501 00000	DISTANCE DISC	
	9	906622 00000	BEARING	
	10	906528 00000	SHAFT SEALING RING	
	12	912820 00000	CAP	
	15	000801 26200	SIDE SHIELD	
	16	000701 26200	SIDE SHIELD	
	17	912871 00000	LOCKING SCREW	
	18	902000 10600	COUPLING PUMP	
	21	945320 00000	HEX HEAD SCREW	
	22	948742 00000	GROOVED PIN	
	24	947732 00000	KEY	
	28	952008 00000	LOCATING PEG	
	29	951705 00000	LOCKING WASHER	
	30	902300 26200	FAN	
	31	947713 00000	KEY	
	32	901808 00000	SHAFT END BOLD	
	33	947507 00000	WASHER	
	41	007801 26200	FLANGE	
	42	533900 26200	VALVE PLATE	
	44	005000 26200	SIEVE	
	46	948219 02000	LOCKING RING	
	49	928602 60000	PRESSURE SPRING	
	52	945325 00000	SOCKET HEAD SCREW	
	54	948802 00000	EYE BOLT	
	57	951228 02000	LOCKING SCREW	
	64	001703 26200	OIL TANK COVER	
	67	003704 26200	COVER	
	69	951005 02000	STUD	
	70	917113 00000	SPRING COLLAR	
	71	947104 00000	HEX.NUT	
	74	305800 02000	COUPLING NUT	
	76	727506 99628	BLOW-OFF VALVE	
	83	965416 00000	OIL SEPARATING ELEMENT (1x) ²⁾	
	89	921500 50000	HANDLE	
	93	945226 00000	HEX. HEAD SCREW	
	94	867800 99559	FLOAT	
	98	912871 00000	LOCKING SCREW	
	101	506000 26200	COARSE SEPARATOR	
	104	008001 26200	SCREEN	
	112	003703 26200	COVER	
	120	916800 10000	COVER	
	130	945387 00000	SOCKET HEAD SCREW	
	131	945319 00000	SOCKET HEAD SCREW	
	132	945323 00000	SOCKET HEAD SCREW	
	134	945324 00000	SOCKET HEAD SCREW	
	141	012211 26200	PIPE	
	143	012218 26200	PIPE	
	148	948401 00000	HOLLOW SCREW	
	150	012209 26200	PIPE	
	152	009400 19000	HOLLOW HOLDING SCREW	
	154	012900 19000	LOCKING SCREW	
	157	960202 26200	COOLER	
	158	012210 26200	PIPE	
	159	948402 00000	HOLLOW SCREW	

H INDEX	Pos.	Ident No.	Description	
	181	018302 26200	COVERING HOOD	
	183	922400 60000	PROTECTIVE SHEET	
	186	568001 10700	INTERMEDIATE PIECE	
	187	568100 10700	SUPPORT PILLAR	
	188	949408 00000	WASHER	
	190	945227 00000	SCREW	
	192	901809 00000	SCREW	
	193	949451 00000	WASHER	
	197	741310 60000	RUBBER BUFFER	
	214	950700 10000	CLAMP	
	215	946304 00000	HEX-HEAD SCREW	
	216	943400 90000	TEMPERATURE PROBE	
	242	902101 10600	COUPLING MOTOR SIDE Ø28MM	
	245	945117 00000	HEX-HEAD SCREW	
	246	948507 00000	SPRING WASHER	
	248	902200 10600	GEAR RIM	
	250	902100 26100	COUPLING MOTOR SIDE (US)	
	251	037900 26200	FLANGES (US)	
	254	945232 00000	HEX-HEAD SCREW (US)	
	281	768706 99626	GAS BALLAST VALVE - OPTIONAL	
	282	741103 99682	OIL LEVEL CONTROL - OPTIONAL	
	283	948086 00000	GASKET	
	301	002407 26200	OIL TANK	
	302	013301 26200	DEFLECTING PLATE	
	303	945211 00000	HEX-HEAD SCREW	
	304	951221 00100	LOCKING SCREW	
	306	907309 00000	OIL SIGHT GLASS	
	307	951220 00100	LOCKING SCREW	
	310	912300 00000	CONNECTING SCREW	
	311	912305 00000	CONNECTING SCREW	
	312	912306 00000	CONNECTING SCREW	
	314	003300 10700	NOZZLE	
	318	952005 00000	LOCATING PEG	
		960009 00000	BECKER LUBE M 100 (MINERAL OIL) - 1L	
		960016 00100	BECKER LUBE S 100 (SYNTHETIC OIL) - 1L	
		960023 00100	BECKER LUBE SL 100 (FOOD SECTOR) - 1L	

¹⁾ Set of seals - 549000 26100 - Pos.: 25, 26, 47, 58, 77, 79, 80, 121, 129, 149, 153, 160, 283, 308, 319
²⁾ necessary order quantity / maintenance

H INDICE	Pos.	No. Identification	Designation	FR	
U 4.100	□	549000 26100	JEU DE JOINTS ¹⁾		
	1	000103 26200	CARCASSE		
	3	020000 26200	PISTON		
	5	900512 00003	PALETTE ON PLASTIQUE (KIT) ²⁾		
	7	917609 00000	JOINT		
	8	917501 00000	DISQUE DE TOLERANCE		
	9	906622 00000	ROULEMENT		
	10	906528 00000	BAGUE D'ETANCHEITE		
	12	912820 00000	COUVERCLE		
	15	000801 26200	COUVERCLE		
	16	000701 26200	COUVERCLE		
	17	912871 00000	BOUCHON		
	18	902000 10600	ACCOUPLLEMENT POMPE		
	21	945320 00000	VIS HEXAGONALE INTERNE		
	22	948742 00000	GOUILLE CANNELEE		
	24	947732 00000	CLAVETTE		
	28	952008 00000	DOVILLE DE ETRAGE		
	29	951705 00000	RONDELLE À RESSORT		
	30	902300 26200	VENTILATEUR		
	31	947713 00000	CLAVETTE		
	32	901808 00000	VIS BOUT D'ARBRE		
	33	947507 00000	RONDELLE		
	41	007801 26200	BRIDE		
	42	533900 26200	CLAPET		
	44	005000 26200	FILTRE		
	46	948219 02000	BAGUE DE SURETE		
	49	928602 60000	RESSORT DE PRESSION		
	52	945325 00000	VIS HEXAGONALE INTERNE		
	54	948802 00000	ANNEAU À VIS		
	57	951228 02000	BOUCHON		
	64	001703 26200	COUVERCLE RESERVOIR D'HUILE		
	67	003704 26200	COUVERCLE		
	69	951005 02000	PRISONNIER		
	70	917113 00000	RONDELLE À RESSORT		
	71	947104 00000	ECROU A 6PANS		
	74	305800 02000	ECROU		
	76	727506 99628	SILENCIEUX		
	83	965416 00000	ELEMENT SEPARATION HUILE (1x) ²⁾		
	89	921500 50000	POIGNEE		
	93	945226 00000	VIS HEXAGONALE		
	94	867800 99559	PIED CAOUTCHOVE		
	98	912871 00000	BOUCHON		
	101	506000 26200	SEPARATEUR A GROS		
	104	008001 26200	TAMIS		
	112	003703 26200	COUVERCLE		
	120	916800 10000	COUVERCLE		
	130	945387 00000	VIS HEXAGONALE INTERNE		
	131	945319 00000	VIS HEXAGONALE INTERNE		
	132	945323 00000	VIS HEXAGONALE INTERNE		
	134	945324 00000	VIS HEXAGONALE INTERNE		
	141	012211 26200	TUYAU		
	143	012218 26200	TUYAU		
	148	948401 00000	VIS CREUSE		
	150	012209 26200	TUYAU		
	152	009400 19000	VIS CREUSE DE FIXATION		
	154	012900 19000	BUCHON		
	157	960202 26200	REFROIDISSEUR		
	158	012210 26200	TUYAU		
	159	948402 00000	VIS CREUSE		

H INDICE	Pos.	No. Identification	Designation	FR	
	181	018302 26200	CARTER		
	183	922400 60000	TOLE DE PROTECTION		
	186	568001 10700	BRIDE		
	187	568100 10700	SUPPORT INTERMEDIAIRE		
	188	949408 00000	RONDELLE		
	190	945227 00000	VIS		
	192	901809 00000	VIS		
	193	949451 00000	RONDELLE		
	197	741310 60000	AMORTISSEUR EN CAOUTCHOUC		
	214	950700 10000	BORNE		
	215	946304 00000	VIS HEXAGONALE		
	216	943400 90000	PALPEUR DE TEMPERATURE		
	242	902101 10600	ACCOUPLLEMENT MOTEUR Ø28MM		
	245	945117 00000	VIS HEXAGONALE		
	246	948507 00000	ANNEAU RESSORT		
	248	902200 10600	ACCOUPLLEMENT ROTEX		
	250	902100 26100	ACCOUPLLEMENT MOTEUR (US)		
	251	037900 26200	BRIDES (US)		
	254	945232 00000	VIS HEXAGONALE (US)		
	281	768706 99626	L'ESTE D'AIR - EN OPTION		
	282	741103 99682	INDICATEUR DE NIVEAU - EN OPTION		
	283	948086 00000	JOINT		
	301	002407 26200	RESERVOIR D'HUILE		
	302	013301 26200	DEFLECTEUR		
	303	945211 00000	VIS HEXAGONALE		
	304	951221 00100	BOUCHON		
	306	907309 00000	VERRE REGARD		
	307	951220 00100	BOUCHON		
	310	912300 00000	VIS DE RACCORD		
	311	912305 00000	VIS DE RACCORD		
	312	912306 00000	VIS DE RACCORD		
	314	003300 10700	GICLEUR		
	318	952005 00000	DOUILLE DE ETRAGE		
		960009 00000	BECKER LUBE M 100 (HUILE MINÉRALE) - 1L		
		960016 00100	BECKER LUBE S 100 (L'HUILE SYNTHÉTIQUE) - 1L		
		960023 00100	BECKER LUBE SL 100 (SECTEUR DE L'ALIMENTATION) - 1L		

¹⁾ Jeu de joints - 549000 26100 - Pos.: 25, 26, 47, 58, 77, 79, 80, 121, 129, 149, 153, 160, 283, 308, 319

²⁾ quantité nécessaire / entretien

H INDICE	Pos.	No. Identificazione	Designazione	IT	
U 4.100	□	549000 26100	SERIE DI GUARNIZIONE ¹⁾		
	1	000103 26200	CARASSA		
	3	020000 26200	ROTORE		
	5	900512 00003	PALETTE IN PLASTICA (KIT) ²⁾		
	7	917609 00000	GUARNIZIONE		
	8	917501 00000	DISCO A DISTANZA		
	9	906622 00000	CUSCINETTO		
	10	906528 00000	ANELLO DI TENUTA		
	12	912820 00000	COPERCHIO		
	15	000801 26200	COPERCHIO		
	16	000701 26200	COPERCHIO		
	17	912871 00000	VITE DI CHIUSURA		
	18	902000 10600	GIUNTO POMPA		
	21	945320 00000	VITE ESAGONALE INTERNA		
	22	948742 00000	SPINA INTAGLIATA		
	24	947732 00000	CHIAVETTA		
	28	952008 00000	SPINE DI RISCONTRO		
	29	951705 00000	RONDELLA A MOLLA		
	30	902300 26200	VENTILATORE		
	31	947713 00000	CHIAVETTA		
	32	901808 00000	VITE DI CHIUSURA ALBERO		
	33	947507 00000	RONDELLA		
	41	007801 26200	FLANGIA		
	42	533900 26200	SUPPORTO VALVOLA		
	44	005000 26200	FILTRO		
	46	948219 02000	ANELLO DI SICUREZZA		
	49	928602 60000	MOLLA DELLA PRESSIONE		
	52	945325 00000	VITE ESAGONALE INTERNA		
	54	948802 00000	VITE AD ANELLO		
	57	951228 02000	VITE DI CHIUSURA		
	64	001703 26200	COPERCHIO SERBATOIO OLIO		
	67	003704 26200	COPERCHIO		
	69	951005 02000	L'ASTA A VITE		
	70	917113 00000	RONDELLA A MOLLA		
	71	947104 00000	DADO ESAGONALE		
	74	305800 02000	DADO DI RISVOLTO		
	76	727506 99628	SILENZIATORE		
	83	965416 00000	CARTUCCIA SEPARATORE OLIO (1x) ²⁾		
	89	921500 50000	MANETTA		
	93	945226 00000	VITE ESAGONALE		
	94	867800 99559	GALLEGGIANTE		
	98	912871 00000	VITE DI CHIUSURA		
	101	506000 26200	SEPARATORE GROSSOLANO		
	104	008001 26200	STACCIO		
	112	003703 26200	COPERCHIO		
	120	916800 10000	COPERCHIO		
	130	945387 00000	VITE ESAGONALE INTERNA		
	131	945319 00000	VITE ESAGONALE INTERNA		
	132	945323 00000	VITE ESAGONALE INTERNA		
	134	945324 00000	VITE ESAGONALE INTERNA		
	141	012211 26200	CONDOTTO		
	143	012218 26200	CONDOTTO		
	148	948401 00000	VITE ESAGONALE		
	150	012209 26200	CONDOTTO		
	152	009400 19000	VITE PASSAGGIO OLIO		
	154	012900 19000	VITE DI CHIUSURA		
	157	960202 26200	RAFFREDDATORE		
	158	012210 26200	CONDOTTO		
	159	948402 00000	VITE ESAGONALE		

H INDICE	Pos.	No. Identificazione	Designazione	IT	
	181	018302 26200	CARTER		
	183	922400 60000	GRIGLIA DI PROTEZIONE		
	186	568001 10700	FLANGE		
	187	568100 10700	SUPPORTO		
	188	949408 00000	RONDELLA		
	190	945227 00000	VITE		
	192	901809 00000	VITE		
	193	949451 00000	RONDELLA		
	197	741310 60000	AMMORTIZZATORE IN GOMMA		
	214	950700 10000	MORSETTO		
	215	946304 00000	VITE ESAGONALE		
	216	943400 90000	TASTATORE TEMPERATURE		
	242	902101 10600	GIUNTO MOTORE Ø28MM		
	245	945117 00000	VITE ESAGONALE		
	246	948507 00000	ANELLO A MOLLA		
	248	902200 10600	GIUNTO ROTEX		
	250	902100 26100	GIUNTO MOTORE (US)		
	251	037900 26200	FLANGE (US)		
	254	945232 00000	VITE ESAGONALE (US)		
	281	768706 99626	VALVOLA DI ZAVORATRICE - OPZIONALE		
	282	741103 99682	SONDA D'OLIO - OPZIONALE		
	283	948086 00000	GUARNIZIONE		
	301	002407 26200	SERBATOIO OLIO		
	302	013301 26200	DEFLETTORE		
	303	945211 00000	VITE ESAGONALE		
	304	951221 00100	VITE DI CHIUSURA		
	306	907309 00000	SPIA LIVELLO OLIO		
	307	951220 00100	VITE DI CHIUSURA		
	310	912300 00000	ATTACO FILETTATO		
	311	912305 00000	ATTACO FILETTATO		
	312	912306 00000	ATTACO FILETTATO		
	314	003300 10700	UGELLO		
	318	952005 00000	SPINE DI RISCONTRO		
		960009 00000	BECKER LUBE M 100 (OLIO MINERALE) - 1L		
		960016 00100	BECKER LUBE S 100 (OLIO SINTETICO) - 1L		
		960023 00100	BECKER LUBE SL 100 (SETTORE ALIMENTARE) - 1L		

¹⁾ Serie di guarnizione - 549000 26100 - Pos.: 25, 26, 47, 58, 77, 79, 80, 121, 129, 149, 153, 160, 283, 308, 319

²⁾ quantità di ordinazione necessari / manutenzione

H INDICE	Pos.	No. De pedido	Descripción	
U 4.100	□	549000 26100	JUNTA COMPLETA ¹⁾	
	1	000103 26200	CARCASA	
	3	020000 26200	ÉMBOLO	
	5	900512 00003	EMPUJADOR DE PLÁSTICO (KIT) ²⁾	
	7	917609 00000	ANILLO DE COJINETE DE JUNTA	
	8	917501 00000	ARANDELA DE AJUSTE	
	9	906622 00000	COJINETE DE RODAMIENTO	
	10	906528 00000	ANILLO DE JUNTA DE ÁRBOL	
	12	912820 00000	TAPA DE CIERRE	
	15	000801 26200	TAPA LATERAL	
	16	000701 26200	TAPA LATERAL	
	17	912871 00000	TORNILLO DE CIERRE	
	18	902000 10600	ACOPLAMIENTO DE SOPLADO	
	21	945320 00000	TORNILLO HEXAGONAL INTERIOR	
	22	948742 00000	PASADOR ENTALLADO DE AJUSTE	
	24	947732 00000	LENGÜETA DE AJUSTE	
	28	952008 00000	CASQUILLO TENSOR	
	29	951705 00000	ARANDELA DE RESORTE	
	30	902300 26200	VENTILADOR CON CUBO	
31	947713 00000	LENGÜETA DE AJUSTE		
32	901808 00000	TORNILLO TERMINAL DE ÁRBOL		
33	947507 00000	ARANDELA		
41	007801 26200	BRIDA ROSCADA		
42	533900 26200	PLACA DE VÁLVULA,COMPLETAO		
44	005000 26200	CRIBA		
46	948219 02000	ANILLO DE ASEGURAMIENTO		
49	928602 60000	MUELLE DE COMPRESIÓN		
52	945325 00000	TORNILLO HEXAGONAL INTERIOR		
54	948802 00000	TORNILLO CON ANILLA		
57	951228 02000	TORNILLO DE CIERRE		
64	001703 26200	TAPA DE RECIPIENTE DE ACEITE		
67	003704 26200	TAPA		
69	951005 02000	ESPÁRRAGO		
70	917113 00000	ARANDELA DE APOYO DEL RESORTE		
71	947104 00000	TUERCA HEXAGONAL		
74	305800 02000	SOBRETUERCA		
76	727506 99628	VÁLVULA DE BARRIDO		
83	965416 00000	ELEMENTO DE DESACEITAR DE AIRE (1x) ²⁾		
89	921500 50000	EMPUÑADURA		
93	945226 00000	TORNILLO DE CABEZA HEXAGONAL		
94	867800 99559	FLOTADOR		
98	912871 00000	TORNILLO DE CIERRE		
101	506000 26200	SEPARADOR DE SÓLIDOS GRUESOS COMPLETO		
104	008001 26200	CHAPA DE FILTRO		
112	003703 26200	TAPA		
120	916800 10000	TAPA ROSCADA		
130	945387 00000	TORNILLO HEXAGONAL INTERIOR		
131	945319 00000	TORNILLO HEXAGONAL INTERIOR		
132	945323 00000	TORNILLO HEXAGONAL INTERIOR		
134	945324 00000	TORNILLO HEXAGONAL INTERIOR		
141	012211 26200	CONDUCTO		
143	012218 26200	CONDUCTO		
148	948401 00000	TORNILLO HUECO		
150	012209 26200	CONDUCTO		
152	009400 19000	TORNILLO DE PIEZA ESFÉRICA		
154	012900 19000	TORNILLO DE CIERRE		
157	960202 26200	REFRIGERADOR		
158	012210 26200	CONDUCTO		
159	948402 00000	TORNILLO HUECO		







H INDICE	Pos.	No. De pedido	Descripción	
	181	018302 26200	CAPERUZA DE RECUBRIMIENTO	
	183	922400 60000	REJILLA DE PROTECCIÓN	
	186	568001 10700	PIEZA INTERMEDIA	
	187	568100 10700	APOYO COMPLETO.	
	188	949408 00000	ARANDELA	
	190	945227 00000	TORNILLO TERMINAL DE ÁRBOL	
	192	901809 00000	TORNILLO	
	193	949451 00000	ARANDELA	
	197	741310 60000	AMORTIGUADOR DE GOMA	
	214	950700 10000	TERMINAL DE CABLE	
	215	946304 00000	TORNILLO DE SUJECIÓN	
	216	943400 90000	SENSOR DE TEMPERATURA	
	242	902101 10600	MITAD DE MOTOR DE ACOPLAMIENTO, Ø28MM	
	245	945117 00000	TORNILLO DE CABEZA HEXAGONAL	
	246	948507 00000	ARANDELA DE MUELLE	
	248	902200 10600	ANILLO DE ACOPLAMIENTO ROJO	
	250	902100 26100	ACOPLAMIENTO DE MOTOR (US)	
	251	037900 26200	BRIDA INTERMEDIA (US)	
	254	945232 00000	TORNILLO DE CABEZA HEXAGONAL (US)	
	281	768706 99626	VÁLVULA DE LASTRE DE GAS - OPCIONAL	
	282	741103 99682	GENERADOR DE NIVEL - OPCIONAL	
	283	948086 00000	JUNTA	
	301	002407 26200	RECIPIENTE DE ACEITE	
	302	013301 26200	DEFLECTOR	
	303	945211 00000	TORNILLO DE CABEZA HEXAGONAL	
	304	951221 00100	TORNILLO DE CIERRE	
	306	907309 00000	CRISTAL MIRILLA DE ACEITE	
	307	951220 00100	TORNILLO DE CIERRE	
	310	912300 00000	TORNILLO DE EMPALME	
	311	912305 00000	TORNILLO DE EMPALME	
	312	912306 00000	TORNILLO DE EMPALME	
	314	003300 10700	TOBERA	
	318	952005 00000	CASQUILLO TENSOR	
		960009 00000	BECKER LUBE M 100 (ACEITE MINERAL) - 1L	
		960016 00100	BECKER LUBE S 100 (ACEITE SINTÉTICO) - 1L	
		960023 00100	BECKER LUBE SL 100 (SECTOR ALIMENTARIO) - 1L	

¹⁾ Junta completa - 549000 26100 - Pos.: 25, 26, 47, 58, 77, 79, 80, 121, 129, 149, 153, 160, 283, 308, 319

²⁾ cantidad necesario / mantenimiento

U 4.100	Variante 	Pos. ²⁾	Bestell Nr. / Ident No. / No. Identification / No. Identificazione / No. De pedido		Beschreibung / Description / Designation / Designazione / Desripcion
① U 4.100 F/K		63	509400 26200		KUGELSTÜCKSCHRAUBE / HOLLOW HOLDING SCREW / VIS CREUSE DE FIXATION / VITE PASSAGGIO OLIO / TORNILLO DE PIEZA ESFÉRICA
		97	912300 00000		ANSCHLUSSSCHRAUBE / CONNECTION SCREW / VIS DE RACCORDEMENT / VITE DI RACCORDO / TORNILLO DE EMPALME
		98		912874-00000	VERSCHLUSS-SCHRAUBE / LOCKING SCREW / BOUCHON / VITE DI CHIUSURA / TORNILLO DE CIERRE
		151	012219 26200		LEITUNG / PIPE / TUYAU / CONDOTTO / CONDUCTO
		154		012900-19000	VERSCHLUSS-SCHRAUBE / LOCKING SCREW / BOUCHON / VITE DI CHIUSURA / TORNILLO DE CIERRE
		233	537500 26200		VENTIL, KOMPL. / VALVE / SOUPAPE / VALVOLA / VÁLVULA COMPLETA
② U 4.100 SA/K-25 ③ U 4.100 F/K-25 - mit Öl-Wasser-Kühler - with oil-to-water heat exchanger - avec réfrigérant à l'huile et à l'eau - con radiatore ad olio - acqua - con refrigerador aceite-agua		29		951705-00000	FEDERSCHEIBE / SPRING DISC / DISQUE DE RESSORT / DISCO A MOLLA / ARANDELA ELÁSTICA
		30		902300-26200	VENTILATOR / FAN / VENTILATEUR / VENTILATORE / ALETA DE VENTILADOR
		31		947713-00000	PASSFEDER / KEY / CLAVETTE / CHIAVETTA / LANGÜETA DE AJUSTE
		32		901808-00000	WELLENENDSCHRAUBE / SHAFT END BOLD / VIS BOUT D'ARBRE / VITE DI CHIUSURA ALBERO / TORNILLO TERMINAL DE ÁRBOL
		33		947507-00000	U-Scheibe / WASHER / RONDELLE / RONDELLA / ARANDELA
		141	012214 26200	012211-26200	LEITUNG / PIPE / TUYAU / CONDOTTO / CONDUCTO
		150	012213 26200	012209-26200	LEITUNG / PIPE / TUYAU / CONDOTTO / CONDUCTO
		155	948420 00000		HOHLSCHRAUBE / HOLLOW SCREW / VIS CREUSE / VITE ESAGONALE / TORNILLO HUECO
		157	960204 26200	960202-26200	KUEHLER / COOLER / REFROIDISSEUR / RAFFREDDATORE / REFRIGERADOR
		158	012212 26200	012210-26200	LEITUNG / PIPE / TUYAU / CONDOTTO / CONDUCTO
		181	018311 26200	018302-26200	HAUBE / HOOD / CARTER / CARTER / CAPERUZA
		192		901809-00000	WELLENENDSCHRAUBE / SCREW / VIS / VITE / TORNILLO
		193		949451-00000	U-SCHEIBE / WASHER / RONDELLE / RONDELLA / ARANDELA
		197	741302 00000	741310-60000	GUMMIPUFFER / RUBBERBUFFER / AMORTISSEUR EN CAOUTCHOUC / AMMORTIZZATORE IN GOMMA / AMORTIGUADOR DE GOMA
		198	945634 00000		GEWINDESTIFT / STUD / PRISONNIER / L'ASTAA VITE / ESPÁRRAGO
211	969438 00000		WINKELSTÜCK / ELBOW / COUDE / GOMITO / CODO		
④ U 4.100 SA/K-51 ⑤ U 4.100 F/K-51 - mit Ölbadheizung, Niveau-Geber und Thermostat - with oil bath heating, level transmitter and heat valve - avec chauffage du bain d'huile, capteur de niveau et thermostat - con riscaldamento a bagno d'olio, indicatore di livello e termostato - con calefacción de baño de aceite, codificador de nivel y termostato		282	741103 99682		NIVEAUGEBER / LEVEL TRANSMITTER / CAPTEUR DE NIVEAU / INDICATORE DI LIVELLO / CODIFICADOR DE NIVEL
		283	948086 00000		DICHTUNG / GASKET / JOINT / GUARNIZIONI / ANILLO
		301	002409 26200	002407-26200	ÖLABSCHEIDERGEHÄUSE / HOUSING FOR OIL SEPARATION / CARCASSE POUR SEPARATION D'HUILLE / CARCASSA SEPARATORE OLIO / CARCASA SEPARADORA DE ACEITE
		304		951221-00100	VERSCHLUSS-SCHRAUBE / LOCKING SCREW / BOUCHON / VITE DI CHIUSURA / TORNILLO DE CIERRE
		305	948029 00000		DICHTUNG / GASKET / JOINT / GUARNIZIONE / JUNTA
		309	912314 00000		ANSCHLUSSSCHRAUBE / CONNECTION SCREW / VIS DE RACCORDEMENT / VITE DI RACCORDO / TORNILLO DE EMPALME
		315	960203 26200		ROHRHEIZKÖRPER / PIPE HEATER / CORPS DE CHAUFFE / SCALDIGLIA / CALEFACTOR TUBULAR
		316	943400 70000		TEMPERATUR-WÄCHTER / THERMOSTAT / THERMOSTAT / INTERRUPTORE TERMICO / TERMOSTATO
		319	948070 00000		DICHTUNG / GASKET / JOINT / GUARNIZIONE / JUNTA

²⁾ variantenabhängige Bauteile / variant-dependent components / composants variante-dependantes / componenti variante-dispendenti / componentes variante-dependientes

U 4.100	Variante 	Pos. ²⁾	Bestell Nr. / Ident No. / No. Identification / No. Identificazione / No. De pedido		Beschreibung / Description / Designation / Designazione / Descripcion
			  	  	
⑥ U 4.100 SA/K-54 - mit zusätzlicher Ölablassbohrung - with additional oil draining bore hole - avec trou de vidange d'huile - con foro di scarico dell'olio aggiuntivo - con perforación de salida de aceite adicional		301	002408 26200	002407 26200	ÖLABSCHEIDERGEHÄUSE / HOUSING FOR OIL SEPARATION / CARCASSE POUR SEPARATION D'HUILLE / CARCASSA SEPARATORE OLIO / CARCASA SEPARADORA DE ACEITE
		307	951220 00100		VERSCHLUSSSCHRAUBE / LOCKING SCREW / BOUCHON / VITE DI CHIUSURA / TORNILLO DE CIERRE
⑦ U 4.100 SA/K-58 ⑧ U 4.100 F/K-58 - Ventilator - Fan - ventilateur - ventilatore - ventilador		29		951705-00000	FEDERSCHEIBE / LOCKING WASHER / RONDELLE À RESSORT / RONDELLA A MOLLA / ARANDELA DE RESORTE
		30	502302 10700	902300 26200	VENTILATOR / FAN / VENTILATEUR / VENTILATORE / VENTILADOR
		32	901804 00000	901808 00000	WELLENENDSCHRAUBE / SCREW / VIS / VITE / TORNILLO
		33	949454 00000	947507 00000	U-SCHEIBE / WASHER / RONDELLE / RONDELLA / ARANDELA
		101	506001 26200	506000 26200	GROBABSCHIEDER KOMPLETT, COARSE SEPARATOR, SEPARATEUR A GROS, SEPARATORE GROSSOLANO, SEPARADOR DE SÓLIDOS GRUESOS COMPLETO
104	008002 26200	008001 26200	FILTERBLECH, SCREEN, TAMIS, STACCIO, CHAPA DE FILTRO		

²⁾ variantenabhängige Bauteile / variant-dependent components / composants variante-dependantes / componenti variante-dispendenti / componentes variante-dependientes