

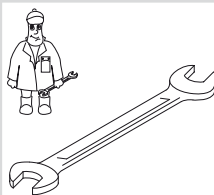

Gebr. Becker GmbH
Hölker Feld 29-31
D-42279 Wuppertal

Wartung
Maintenance
Entretien
Manutenzione
Mantenimiento



	Pos.	Menge Quantity Quantité Quantità Cantidad	Bestell-Nr. Ident No. No. Identification No. Identificazione No. de pedido	Bezeichnung Description Designation Designazione Descripción
SV 7.190	125	1*	909568 00000	Filterpatrone, Filter cartridge, Cartouche Filtrante, Cartuccia filtro, Cartucho de filtro

* erforderlich / necessary / nécessaire / necessaria / necesaria (F / DSF / VSF)



Ersatzteilliste
Spare parts list
Liste de pièces de rechange
Listino pezzi di ricambio
Lista de piezas de recambio
Lista de peças sobresselentes
Reserveonderdelenlijst
Reservedelsliste
Reservdelslista

Reservedelsliste
Varaosaluettelo
Wykaz części zamiennych
Seznam náhradních dílů
Tartalékalkatrész lista
Κατάλογος ανταλλακτικών
Перечень запасных частей
备用零件目录
スベアパーツリスト

SV 7.190

28000019600 10/2011



SERVICE

BECKER
D-42279 Wuppertal
www.becker-international.com

CE

year

No.

type ← Option

frequency Hz

speed min⁻¹

power required kW

inlet capacity m³/h

pressure + mbar

vacuum - mbar

Made in Germany

SERVICE

www.becker-international.com

Sales and service network

Index	Pos.	Bestell Nr.	Beschreibung 
SV 7.190	U	570400 19600	UMBAUSATZ /1⇒/2 (POS: 67, 119, 181, 183, 184, 185, 188)
	10	741315 00000	GUMMIPUFFER
	11	515100 19600	FUSS
	12	515101 19600	FUSS, SEITLICH
	21	018300 92000	SCHUTZSCHEIBE
	22	001101 83000	LAGERDECKEL
	23	906612 10000	WÄLZLAGER
	27	000100 19600	GEHÄUSE
	28	001103 19600	LAGERDECKEL
	29	911310 00000	DICHTUNGSSCHLAUCH
	30	948503 00000	FEDERRING
	31	945309 00000	INNENSECHSKANTSCHRAUBE
	32	951704 00000	FEDERSCHEIBE
	33	945397 00000	INNENSECHSKANTSCHRAUBE
	36	945311 00000	INNENSECHSKANTSCHRAUBE
	41	013900 19600	DICHTBUCHSE
	42	911464 00000	DISTANZSCHEIBE 24X45X0,025
	43	911465 00000	DISTANZSCHEIBE 24X45X0,050
	44	911466 00000	DISTANZSCHEIBE 24X45X0,100
	45	911467 00000	DISTANZSCHEIBE 24X45X0,200
	48	947736 00000	PASSFEDER
	49	000603 19600	LAUFRAD
	50	949405 00000	UNTERLEGSCHLEIBE
	51	945270 00000	WELLENABSCHLUSSCHRAUBE
	63	000200 19600	GEHÄUSEDECKEL
	67	951703 00000	FEDERSCHEIBE
	68	945224 00000	SECHSKANTSCHRAUBE
	101	007400 19600	SCHALLDÄMPFERGEHÄUSE
	102.1	907600 60000	SIEBROHR (SV 7.190/1-01)
	102.2	907600 50000	SIEBROHR (SV 7.190/2-01)
	103.1	907701 70000	DÄMPFER (SV 7.190/1-01)
	103.2	907701 50000	DÄMPFER (SV 7.190/2-01)
	104	907500 19600	DICHTUNG
	105	007800 19600	GEWINDEFLANSCH
	107	949451 00000	UNTERLEGSCHLEIBE
	108	903804 01000	ZUGANKERSCHRAUBE
109	903805 01000	ZUGANKERSCHRAUBE	
110	903803 01000	ZUGANKERSCHRAUBE	
111	945225 00000	SECHSKANTSCHRAUBE	
113	040100 19600	FILTERGEHÄUSE	
115	945321 00000	INNENSECHSKANTSCHRAUBE	
119	945371 00000	INNENSECHSKANTSCHRAUBE	
121	951007 00000	STIFTSCHRAUBE	
125	909568 00000	FILTERPATRONE (1x) ¹⁾	
127	040200 19700	FILTERDECKEL	
131	921503 00000	STERNGRIF	
134	016600 19600	ANSCHLUSSSTÜCK	
136	948120 00000	SEEGER-RING	
137	040201 19700	FILTERDECKEL	
140	945373 00000	INNENSECHSKANTSCHRAUBE	
181	015500 19600	REDUZIERSTÜCK	
183	005602 19600	DECKEL	
184	907502 19600	DICHTUNG	
185	005600 19600	DECKEL	
188	945320 00000	SECHSKANTSCHRAUBE	
201	015100 19600	FUSS	
202	947504 00000	UNTERLEGSCHLEIBE	
203	945223 00000	SECHSKANTSCHRAUBE	
204	951906 00000	KABELTÜLLE	

Index	Pos.	Bestell Nr.	Beschreibung 
SV 7.190	205	015101 19600	FUSS
	207	945328 00000	INNENSECHSKANTSCHRAUBE
	301	007401 19600	SCHALLDÄMPFERGEHÄUSE
	302	907600 70100	SIEBROHR
	303	907702 10000	DÄMPFER
	400.1	733700 99581	VENTILEINSATZ, SV 7.190/1; 1,1/1,3KW
	400.2	733701 99581	VENTILEINSATZ, SV 7.190/1; 1,5/1,8KW
	400.3	733702 99581	VENTILEINSATZ, SV 7.190/2

Variante	/1-05	MIT KORROSIONSSCHUTZ ²⁾	
	/2-05		
	181	570410 19600	UMBAUSATZ /1⇒/2
	185	015510 19600	- REDUZIERSTÜCK
		005610 19600	- DECKEL
		570201 19600	VERDICHTER / VAKUUMPUMPE
	27	000110 19600	- GEHÄUSE
	28	001110 19600	- LAGERDECKEL
	29	906591 00000	- WELLENDICHTUNG
	49	000613 19600	- LAUFRAD
	63	000210 19600	- GEHÄUSEDECKEL
		570316 19600	SCHALLDÄMPFER MIT FILTER
	113	040110 19600	- FILTERGEHÄUSE
	301	007411 19601	- SCHALLDÄMPFERGEHÄUSE
		570315 19600	SCHALLDÄMPFER MIT VENTILEINSATZ
	113	040110 19600	- FILTERGEHÄUSE
	134	016610 19600	- ANSCHLUSSSTÜCK
	301	007411 19601	- SCHALLDÄMPFERGEHÄUSE
		570301 19600	SCHALLDÄMPFER
	101	007410 19601	- SCHALLDÄMPFERGEHÄUSE
	102	907600 60100	- SIEBROHR
		570314 19600	SCHALLDÄMPFER MIT VENTILEINSATZ + FILTER
	113	040110 19600	- FILTERGEHÄUSE (2x)
	134	016610 19600	- ANSCHLUSSSTÜCK

Variante (Index A)	/1-401	MIT FREQUENZUMRICHTER ²⁾	
	/2-401		
	183	570402 19600	UMBAUSATZ /1⇒/2
		005601 19600	- DECKEL
		570205 19600	VERDICHTER / VAKUUMPUMPE
	49	000604 19600	- LAUFRAD
	500	596302 41115	FREQUENZUMRICHTER

¹⁾ erforderliche Bestellmenge / Wartung (F / DSF / VSF)

²⁾ variantenabhängige Bauteile

Zeichnung - siehe Anhang 

Index	Pos.	Ident No.	Description 
SV 7.190	U	570400 19600	CONVERSION KIT /1⇒/2 (POS: 67, 119, 181, 183, 184, 185, 188)
	10	741315 00000	RUBBER BUFFER
	11	515100 19600	FOOT
	12	515101 19600	FOOT, LATERAL
	21	018300 92000	WASHER
	22	001101 83000	BEARING COVER
	23	906612 10000	BALL BEARING
	27	000100 19600	PUMP BODY
	28	001103 19600	BEARING COVER
	29	911310 00000	SEAL
	30	948503 00000	LOCK WASHER
	31	945309 00000	SOCKET HEAD SCREW
	32	951704 00000	LOCKING WASHER
	33	945397 00000	SOCKET HEAD SCREW
	36	945311 00000	SOCKET HEAD SCREW
	41	013900 19600	SEALING BUSH
	42	911464 00000	DISTANCE DISC 24X45X0,025
	43	911465 00000	DISTANCE DISC 24X45X0,05
	44	911466 00000	DISTANCE DISC 24X45X0,1
	45	911467 00000	DISTANCE DISC 24X45X0,2
48	947736 00000	KEY	
49	000603 19600	IMPELLER	
50	949405 00000	WASHER	
51	945270 00000	SCREW	
63	000200 19600	HOUSING LID	
67	951703 00000	LOCKING WASHER	
68	945224 00000	HEX-HEAD SCREW	
101	007400 19600	SILENCER HOUSING	
102.1	907600 60000	STRAINER TUBE (SV 7.190/1-01)	
102.2	907600 50000	STRAINER TUBE (SV 7.190/2-01)	
103.1	907701 70000	SILENCER SPONGE (SV 7.190/1-01)	
103.2	907701 50000	SILENCER SPONGE (SV 7.190/2-01)	
104	907500 19600	SEAL	
105	007800 19600	FLANGE	
107	949451 00000	WASHER	
108	903804 01000	SCREW	
109	903805 01000	SCREW	
110	903803 01000	SCREW	
111	945225 00000	HEX-HEAD SCREW	
113	040100 19600	FILTER HOUSING	
115	945321 00000	SOCKET HEAD SCREW	
119	945371 00000	SOCKET HEAD SCREW	
121	951007 00000	STUD	
125	909568 00000	FILTER CARTRIDGE (1x) ¹⁾	
127	040200 19700	FILTER COVER	
131	921503 00000	STAR GRIP	
134	016600 19600	CONNECTING PIECE	
136	948120 00000	SEEGER-LOCKRING	
137	040201 19700	FILTER COVER	
140	945373 00000	SOCKET HEAD SCREW	
181	015500 19600	REDUCING PIECE	
183	005602 19600	CAP	
184	907502 19600	GASKET	
185	005600 19600	CAP	
188	945320 00000	HEX-HEAD SCREW	
201	015100 19600	FOOT	
202	947504 00000	WASHER	
203	945223 00000	HEX-HEAD SCREW	
204	951906 00000	RUBBER BUSHING	

Index	Pos.	Ident No.	Description 
SV 7.190	205	015101 19600	FOOT
	207	945328 00000	SOCKET HEAD SCREW
	301	007401 19600	SILENCER HOUSING
	302	907600 70100	STRAINER GAUZE
	303	907702 10000	SILENCER SPONGE
	400.1	733700 99581	VALVE CORE, SV 7.190/1; 1,1/1,3KW
	400.2	733701 99581	VALVE CORE, SV 7.190/1; 1,5/1,8KW
	400.3	733702 99581	VALVE CORE, SV 7.190/2

Variant	/1-05	WITH CORROSION PROTECTION ²⁾	
	/2-05		
	181	570410 19600	CONVERSION KIT /1⇒/2
	185	015510 19600	- REDUCING PIECE
		005610 19600	- CAP
	27	570201 19600	BLOWER / VACUUM PUMP
	28	000110 19600	- PUMP BODY
	28	001110 19600	- BEARING COVERL
	29	906591 00000	- SEAL
	49	000613 19600	- IMPELLER
	63	000210 19600	- HOUSING LID
		570316 19600	SILENCER WITH FILTER
	113	040110 19600	- FILTER HOUSING
	301	007411 19601	- SILENCER HOUSING
		570315 19600	SILENCER WITH VALVE CORE
	113	040110 19600	- FILTER HOUSING
	134	016610 19600	- CONNECTING PIECE
	301	007411 19601	- SILENCER HOUSING
		570301 19600	SILENCER
	101	007410 19601	- SILENCER HOUSING
	102	907600 60100	- STRAINER GAUZE
		570314 19600	SILENCER WITH VALVE CORE + FILTER
	113	040110 19600	- FILTER HOUSING (2x)
	134	016610 19600	- CONNECTING PIECE

Variant (Index A)	/1-401	WITH FREQUENCY INVERTER ²⁾	
	/2-401		
	183	570402 19600	CONVERSION KIT /1⇒/2
		005601 19600	- CAP
		570205 19600	BLOWER / VACUUM PUMP
	49	000604 19600	- IMPELLER
	500	596302 41115	FREQUENCY INVERTER

¹⁾ necessary order quantity / maintenance (F / DSF / VSF)

²⁾ variant-dependent components

Drawing - see appendix 

Index	Pos.	No. Identification	Designation 
SV 7.190	U	570400 19600	KIT DE TRANSFORMATION /1⇒ /2 (POS: 67, 119, 181, 183, 184, 185, 188)
	10	741315 00000	AMORTISSEUR EN CAOUTCHOUC
	11	515100 19600	PIED
	12	515101 19600	PIED
	21	018300 92000	PLAQUE
	22	001101 83000	COUVERCLE DE ROULEMENT
	23	906612 10000	ROULEMENT A BILLES
	27	000100 19600	CORP DE POMPE
	28	001103 19600	COUVERCLE DE ROULEMENT
	29	911310 00000	JOINT
	30	948503 00000	RONDELLE ÉLASTIQUE
	31	945309 00000	VIS HEXAGONALE INTERNE
	32	951704 00000	RONDELLE À RESSORT
	33	945397 00000	VIS HEXAGONALE INTERNE
	36	945311 00000	VIS HEXAGONALE INTERNE
	41	013900 19600	BOISSEAU ETANCHANT
	42	911464 00000	DISQUE AJUSTAGE 24X45X0,025
	43	911465 00000	DISQUE AJUSTAGE 24X45X0,05
	44	911466 00000	DISQUE AJUSTAGE 24X45X0,1
	45	911467 00000	DISQUE AJUSTAGE 24X45X0,2
48	947736 00000	CLAVETTE	
49	000603 19600	ROUE	
50	949405 00000	RONDELLE	
51	945270 00000	VIS	
63	000200 19600	COUVERCLE	
67	951703 00000	RONDELLE À RESSORT	
68	945224 00000	VIS HEXAGONALE	
101	007400 19600	CARCASSE SILENCIEUX	
102.1	907600 60000	GRILLE POUR SILENCIEUX (SV 7.190/1-01)	
102.2	907600 50000	GRILLE POUR SILENCIEUX (SV 7.190/2-01)	
103.1	907701 70000	MOUSSE POUR SILENCIEUX (SV 7.190/1-01)	
103.2	907701 50000	MOUSSE POUR SILENCIEUX (SV 7.190/2-01)	
104	907500 19600	JOINT	
105	007800 19600	BRIDE	
107	949451 00000	RONDELLE	
108	903804 01000	VIS	
109	903805 01000	VIS	
110	903803 01000	VIS	
111	945225 00000	VIS HEXAGONALE	
113	040100 19600	CARTER FILTRE	
115	945321 00000	VIS HEXAGONALE INTERNE	
119	945371 00000	VIS HEXAGONALE INTERNE	
121	951007 00000	GOUJON	
125	909568 00000	CARTOUCHE FILTRANTE (1x) ¹⁾	
127	040200 19700	COUVERCLE DU FILTRE	
131	921503 00000	POIGNEE-ETOILE	
134	016600 19600	PIECE DE RACCORDEMENT	
136	948120 00000	BAGUE DE SURETE	
137	040201 19700	COUVERCLE DU FILTRE	
140	945373 00000	VIS HEXAGONALE INTERNE	
181	015500 19600	PIECE DE REDUCTION	
183	005602 19600	COUVERCLE	
184	907502 19600	JOINT	
185	005600 19600	COUVERCLE	
188	945320 00000	VIS HEXAGONALE	
201	015100 19600	PIED	
202	947504 00000	RONDELLE	
203	945223 00000	VIS HEXAGONALE	
204	951906 00000	PROTECTION EN CAOUTCHOUC	

Index	Pos.	No. Identification	Designation 
SV 7.190	205	015101 19600	PIED
	207	945328 00000	VIS HEXAGONALE INTERNE
	301	007401 19600	CARCASSE SILENCIEUX
	302	907600 70100	GRILLE POUR SILENCIEUX
	303	907702 10000	MOUSSE POUR SILENCIEUX
	400.1	733700 99581	SOUPAPE, SV 7.190/1; 1,1/1,3KW
	400.2	733701 99581	SOUPAPE, SV 7.190/1; 1,5/1,8KW
	400.3	733702 99581	SOUPAPE, SV 7.190/2

Variante	/1-05	AVEC PROT. CONTRE LA CORROSION ²⁾	
	/2-05		
	181	570410 19600	KIT DE TRANSFORMATION /1⇒ /2
	185	015510 19600	- PIECE DE REDUCTION
		005610 19600	- COUVERCLE
		570201 19600	SOUFFLANTE / POMPE A VIDE
	27	000110 19600	- CORP DE POMPE
	28	001110 19600	- COUVERCLE DE ROULEMENT
	29	906591 00000	- JOINT
	49	000613 19600	- ROUE
	63	000210 19600	- COUVERCLE
		570316 19600	SILENCIEUX AVEC FILTRE
	113	040110 19600	- CARTER FILTRE
	301	007411 19601	- CARCASSE SILENCIEUX
		570315 19600	SILENCIEUX AVEC SOUPAPE
	113	040110 19600	- CARTER FILTRE
	134	016610 19600	- PIECE DE RACCORDEMENT
	301	007411 19601	- CARCASSE SILENCIEUX
		570301 19600	SILENCIEUX
	101	007410 19601	- CARCASSE SILENCIEUX
	102	907600 60100	- GRILLE POUR SILENCIEUX
		570314 19600	SILENCIEUX AVEC SOUPAPE + FILTRE
	113	040110 19600	- CARTER FILTRE (2x)
	134	016610 19600	- PIECE DE RACCORDEMENT

Variante (Index A)	/1-401	AVEC CONVERTISSEUR DE FRÉQUENCE ²⁾	
	/2-401		
	183	570402 19600	KIT DE TRANSFORMATION /1⇒ /2
		005601 19600	- COUVERCLE
		570205 19600	SOUFFLANTE / POMPE A VIDE
	49	000604 19600	- ROUE
	500	596302 41115	CONVERTISSEUR DE FRÉQUENCE

¹⁾ quantité nécessaire / entretien (F / DSF / VSF)

²⁾ composants variante-dependantes

plan - voir annexe 

Index	Pos.	No. Identificazione	Designazione 
SV 7.190	U	570400 19600	SET DI TRASFORMAZIONE /1⇒ /2 (POS: 67, 119, 181, 183, 184, 185, 188)
	10	741315 00000	AMMORTIZZATORE IN GOMMA
	11	515100 19600	PIEDE
	12	515101 19600	PIEDE
	21	018300 92000	DISCO
	22	001101 83000	COPERCHIO CUSCINETTO
	23	906612 10000	CUSCINETTO A SFERA
	27	000100 19600	CARCASSA
	28	001103 19600	COPERCHIO CUSCINETTO
	29	911310 00000	GUARNIZIONE
	30	948503 00000	ANELLO A MOLLA
	31	945309 00000	VITE ESAGONALE INTERNA
	32	951704 00000	DISCO A MOLLA
	33	945397 00000	VITE ESAGONALE INTERNA
	36	945311 00000	VITE ESAGONALE INTERNA
	41	013900 19600	BUSSOLA GUARNIRANTE
	42	911464 00000	DISCO GIUOCO 24X45X0,025
	43	911465 00000	DISCO GIUOCO 24X45X0,05
	44	911466 00000	DISCO GIUOCO 24X45X0,1
	45	911467 00000	DISCO GIUOCO 24X45X0,2
	48	947736 00000	CHIAVETTA
	49	000603 19600	GIRANTE
	50	949405 00000	RONDELLA
	51	945270 00000	VITE
	63	000200 19600	COPERCHIO
	67	951703 00000	DISCO A MOLLA
	68	945224 00000	VITE ESAGONALE
	101	007400 19600	CARCASSA SILEZIATORE
	102.1	907600 60000	TUBO-CRIVELLO (SV 7.190/1-01)
	102.2	907600 50000	TUBO-CRIVELLO (SV 7.190/2-01)
	103.1	907701 70000	MATERIALE PER SILENZIATORE (SV 7.190/1-01)
	103.2	907701 50000	MATERIALE PER SILENZIATORE (SV 7.190/2-01)
	104	907500 19600	GUARNIZIONE
	105	007800 19600	FLANGIA
	107	949451 00000	RONDELLA
	108	903804 01000	VITE
109	903805 01000	VITE	
110	903803 01000	VITE	
111	945225 00000	VITE ESAGONALE	
113	040100 19600	CARCASSA DEL FILTRO	
115	945321 00000	VITE ESAGONALE INTERNA	
119	945371 00000	VITE ESAGONALE INTERNA	
121	951007 00000	VITE PRIGIONIERA	
125	909568 00000	CARTUCCIA FILTRO (1x) ¹⁾	
127	040200 19700	COPERCHIO FILTRO	
131	921503 00000	MANOPOLA A CROCIERA	
134	016600 19600	PEZZO DI RACORDO	
136	948120 00000	ANELLO DI SICUREZZA	
137	040201 19700	COPERCHIO FILTRO	
140	945373 00000	VITE ESAGONALE INTERNA	
181	015500 19600	GIUNTO DI RIDUZIONE	
183	005602 19600	COPERCHIO	
184	907502 19600	GUARNIZIONE	
185	005600 19600	COPERCHIO	
188	945320 00000	VITE ESAGONALE	
201	015100 19600	PIEDE	
202	947504 00000	RONDELLA	
203	945223 00000	VITE ESAGONALE	
204	951906 00000	PROTEZIONE IN GOMMA	

Index	Pos.	No. Identificazione	Designazione 
SV 7.190	205	015101 19600	PIEDE
	207	945328 00000	VITE ESAGONALE INTERNA
	301	007401 19600	CARCASSA SILENZIATORE
	302	907600 70100	GRIGLIA PER SILENZIATORE
	303	907702 10000	MATERIALE PER SILENZIATORE
	400.1	733700 99581	VALVOLA, SV 7.190/1; 1,1/1,3KW
	400.2	733701 99581	VALVOLA, SV 7.190/1; 1,5/1,8KW
	400.3	733702 99581	VALVOLA, SV 7.190/2

Variante	/1-05	CON PROTEZIONE ANTI-CORROSIONE ²⁾	
	/2-05		
	181	570410 19600	SET DI TRASFORMAZIONE /1⇒ /2
	185	015510 19600	- GIUNTO DI RIDUZIONE
		005610 19600	- COPERCHIO
		570201 19600	SOFFIANTE / POMPA A VUOTO
	27	000110 19600	- CARCASSA
	28	001110 19600	- COPERCHIO CUSCINETTO
	29	906591 00000	- GUARNIZIONE
	49	000613 19600	- GIRANTE
	63	000210 19600	- COPERCHIO
		570316 19600	SILENZIATORE CON FILTRO
	113	040110 19600	- CARCASSA DEL FILTRO
	301	007411 19601	- CARCASSA SILENZIATORE
		570315 19600	SILENZIATORE CON VALVOLA
	113	040110 19600	- CARCASSA DEL FILTRO
	134	016610 19600	- PEZZO DI RACORDO
	301	007411 19601	- CARCASSA SILENZIATORE
		570301 19600	SILENZIATORE
	101	007410 19601	- CARCASSA SILENZIATORE
	102	907600 60100	- GRIGLIA PER SILENZIATORE
		570314 19600	SILENZIATORE CON VALVOLA + FILTRO
	113	040110 19600	- CARCASSA DEL FILTRO (2x)
	134	016610 19600	- PEZZO DI RACORDO

Variante (Index A)	/1-401	CON CONVERTITORE DI FREQUENZA ²⁾	
	/2-401		
	183	570402 19600	SET DI TRASFORMAZIONE /1⇒ /2
		005601 19600	- COPERCHIO
		570205 19600	SOFFIANTE / POMPA A VUOTO
	49	000604 19600	- GIRANTE
	500	596302 41115	CONVERTITORE DI FREQUENZA

¹⁾ quantità di ordinazione necessari / manutenzione (F / DSF / VSF)

²⁾ componenti variante-dipendenti

Disegno - vedere allegato 

Index	Pos.	No. De pedido	Descripción
SV 7.190	U	570400 19600	EQUIPO PARA LA CONVERSIÓN /1⇒ /2 (POS: 67, 119, 181, 183, 184, 185, 188)
	10	741315 00000	AMORTIGUADOR DE GOMA
	11	515100 19600	PIE COMPLETO
	12	515101 19600	PIE COMPLETO, LATERAL
	21	018300 92000	DISCO DE PROTECCIÓN
	22	001101 83000	TAPA DE COJINETE
	23	906612 10000	COJINETE DE RODAMIENTO
	27	000100 19600	CARCASA
	28	001103 19600	TAPA DE COJINETE
	29	911310 00000	MANGUERA DE JUNTA
	30	948503 00000	ARANDELA DE MUELLE
	31	945309 00000	TORNILLO HEXAGONAL INTERIOR
	32	951704 00000	ARANDELA ELÁSTICA
	33	945397 00000	TORNILLO HEXAGONAL INTERIOR
	36	945311 00000	TORNILLO HEXAGONAL INTERIOR
	41	013900 19600	CASQUILLO DE JUNTA
	42	911464 00000	ARANDELA DISTANCIADORA 24X45X0,025
	43	911465 00000	ARANDELA DISTANCIADORA 24X45X0,050
	44	911466 00000	ARANDELA DISTANCIADORA 24X45X0,100
	45	911467 00000	ARANDELA DISTANCIADORA 24X45X0,200
	48	947736 00000	LENGÜETA DE AJUSTE
	49	000603 19600	RUEDA CORREDERA
	50	949405 00000	ARANDELA
	51	945270 00000	TORNILLO TERMINAL DE ÁRBOL
	63	000200 19600	TAPA DE CARCASA
	67	951703 00000	ARANDELA ELÁSTICA
	68	945224 00000	TORNILLO DE CABEZA HEXAGONAL
	101	007400 19600	CARCASA DE SILENCIADOR
	102.1	907600 60000	TUBO DE CRIBA (SV 7.190/1-01)
	102.2	907600 50000	TUBO DE CRIBA (SV 7.190/2-01)
	103.1	907701 70000	AMORTIGUADOR (SV 7.190/1-01)
	103.2	907701 50000	AMORTIGUADOR (SV 7.190/2-01)
	104	907500 19600	JUNTA
	105	007800 19600	BRIDA ROSCADA
	107	949451 00000	ARANDELA
	108	903804 01000	TORNILLO TIRANTE
	109	903805 01000	TORNILLO TIRANTE
	110	903803 01000	TORNILLO TIRANTE
	111	945225 00000	TORNILLO DE CABEZA HEXAGONAL
	113	040100 19600	CARCASA DE FILTRO
115	945321 00000	TORNILLO HEXAGONAL INTERIOR	
119	945371 00000	TORNILLO HEXAGONAL INTERIOR	
121	951007 00000	ESPÁRRAGO	
125	909568 00000	CARTUCHO DE FILTRO (1x) ¹⁾	
127	040200 19700	TAPA DE FILTRO	
131	921503 00000	EMPUÑADURA DE ESTRELLA	
134	016600 19600	PIEZA DE EMPALME	
136	948120 00000	ANILLO DE RETENCIÓN	
137	040201 19700	TAPA DE FILTRO	
140	945373 00000	TORNILLO HEXAGONAL INTERIOR	
181	015500 19600	PIEZA DE REDUCCIÓN	
183	005602 19600	TAPA	
184	907502 19600	JUNTA	
185	005600 19600	TAPA	
188	945320 00000	TORNILLO DE CABEZA HEXAGONAL	
201	015100 19600	PIE	
202	947504 00000	ARANDELA	
203	945223 00000	TORNILLO DE CABEZA HEXAGONAL	
204	951906 00000	BOQUILLA DE CABLE	

Index	Pos.	No. De pedido	Descripción
SV 7.190	205	015101 19600	PIE
	207	945328 00000	TORNILLO HEXAGONAL INTERIOR
	301	007401 19600	CARCASA DE SILENCIADOR
	302	907600 70100	TUBO DE CRIBA
	303	907702 10000	AMORTIGUADOR
	400.1	733700 99581	VÁLVULA, SV 7.190/1; 1,1/1,3KW
	400.2	733701 99581	VÁLVULA, SV 7.190/1; 1,5/1,8KW
	400.3	733702 99581	VÁLVULA, SV 7.190/2

Variante	/1-05	CON PROTECCIÓN CONTRA LA CORROSION ²⁾	
	/2-05		
	181	570410 19600	EQUIPO PARA LA CONVERSIÓN /1⇒ /2
	185	015510 19600	- PIEZA DE REDUCCIÓN
		005610 19600	- TAPA
		570201 19600	SOPLANTES / BOMBA DE VACIO
	27	000110 19600	- CARCASA
	28	001110 19600	- TAPA DE COJINETE
	29	906591 00000	- MANGUERA DE JUNTA
	49	000613 19600	- RUEDA CORREDERA
	63	000210 19600	- TAPA DE CARCASA
		570316 19600	SILENCIADOR CON FILTRO
	113	040110 19600	- CARCASA DE FILTRO
	301	007411 19601	- CARCASA DE SILENCIADOR
		570315 19600	SILENCIADOR CON VÁLVULA
	113	040110 19600	- CARCASA DE FILTRO
	134	016610 19600	- PIEZA DE EMPALME
	301	007411 19601	- CARCASA DE SILENCIADOR
		570301 19600	SILENCIADOR
	101	007410 19601	- CARCASA DE SILENCIADOR
	102	907600 60100	- TUBO DE CRIBA
		570314 19600	SILENCIADOR CON VÁLVULA + FILTRO
	113	040110 19600	- CARCASA DE FILTRO (2x)
	134	016610 19600	- PIEZA DE EMPALME

Variante (Index A)	/1-401	CON CONVERTIDOR DE FRECUENCIA ²⁾	
	/2-401		
	183	570402 19600	EQUIPO PARA LA CONVERSIÓN /1⇒ /2
		005601 19600	- TAPA
		570205 19600	SOPLANTES / BOMBA DE VACIO
	49	000604 19600	- RUEDA CORREDERA
	500	596302 41115	CONVERTIDOR DE FRECUENCIA

¹⁾ cantidad necesario / mantenimiento (F / DSF / VSF)

²⁾ componentes variante-dependientes

Dibujo - véase apéndice 

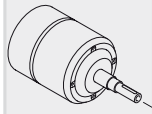

SERVICE ?

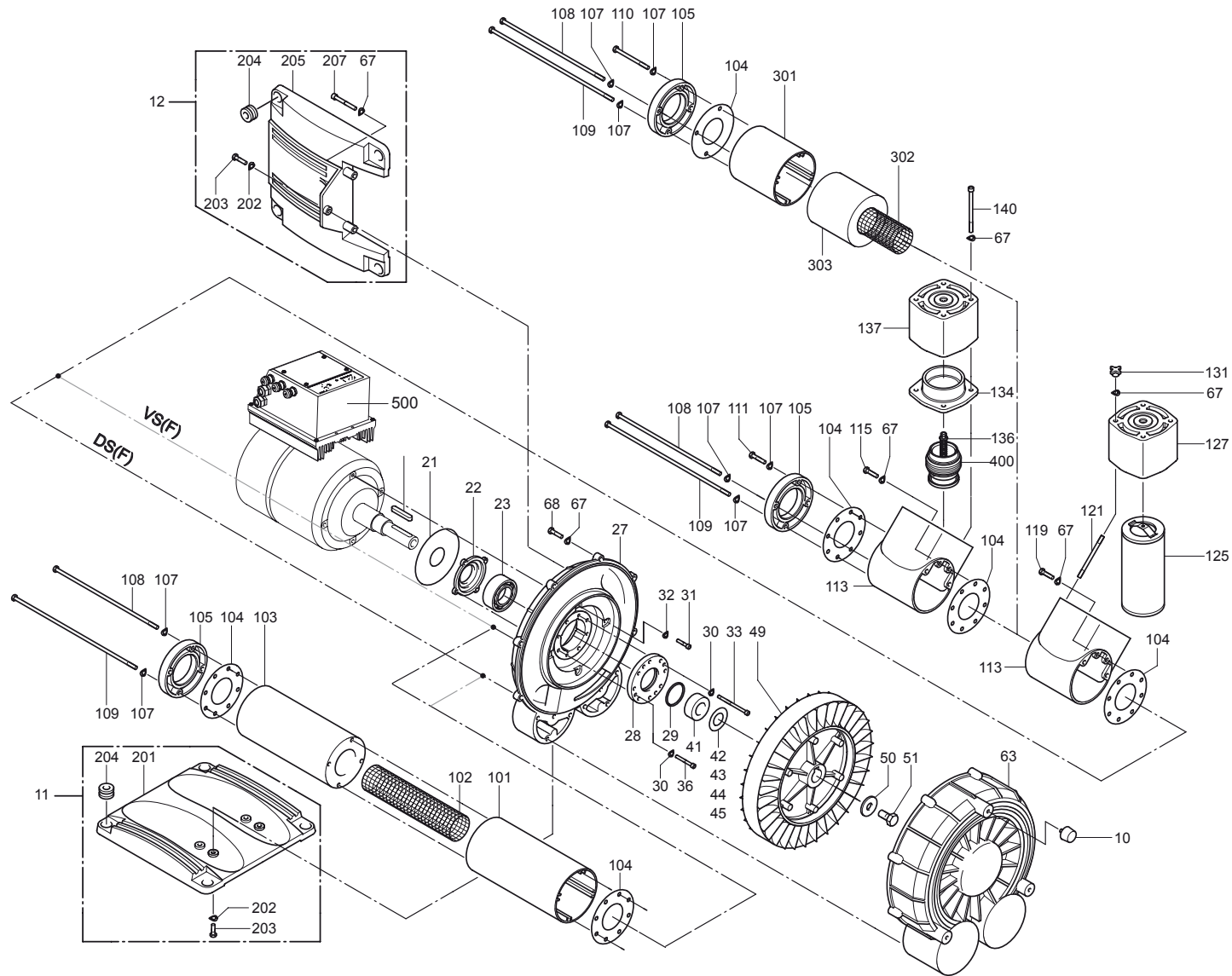
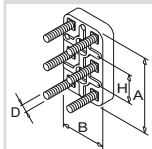
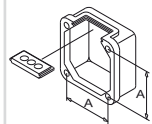
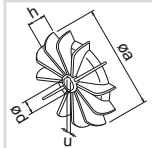
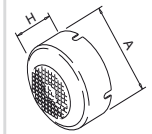

SV 7.190/1

SV 7.190/2

