

SV 8.160/1
SV 8.160/2

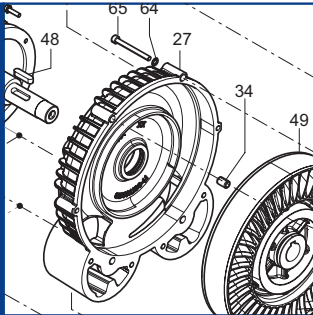

SERVICE

BECKER
D-42279 Wuppertal
www.becker-international.com

year

No **K** **Index Variante**

type **SV 8.160/X-XX**

frequency Hz

speed min⁻¹

power required kW

inlet capacity m³/h

pressure + mbar

vacuum - mbar

Made in Germany

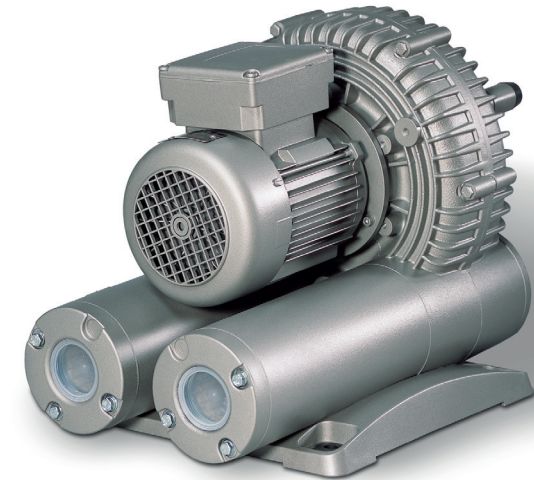

Ersatzteilliste
Spare parts list
Liste de pièces de rechange
Listino pezzi di ricambio
Lista de piezas de recambio
Lista de peças sobresselentes
Reserveonderdelenlijst
Atsarginių dalių sąrašas
Varuosad nimekirja
Rezerves daļu saraksts

Reservedelsliste
Reservdelslista
Varaosaluettelo
Reservedelsliste
Wykaz części zamiennych
Tartalékalkatrész lista
Seznam náhradních dílů
Seznam nadomestnih delov
Zoznam náhradných dielov
Rezervni dijelovi popis

Lista pieselor de schimb
Páirteanna spártha liosta
Κατάλογος ανταλλακτικών
Yedek parça listesi
Списък на резервните части
Перечень запасных частей
スペアパーツリスト
예비 부품 목록
备用零件目录

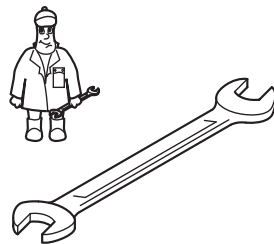

Pos.	Menge ¹⁾ Quantity Quantité Quantità Cantidad	Bestell-Nr. Ident No. No. Identification No. Identificazione No. de pedido	Bezeichnung Description Designation Designazione Descripción
125	1	909568 00000	Filterpatrone, filter cartridge, cartouche filtrante, cartuccia filtro, cartucho

¹⁾ erforderliche Bestellmenge / necessary order quantity / quantité nécessaire / quantità di ordinazione necessari / cantidad necesario

Wartung
Maintenance
Entretien
Manutenzione
Mantenimiento



www.becker-international.com

Sales and service network

SV 8.160/1

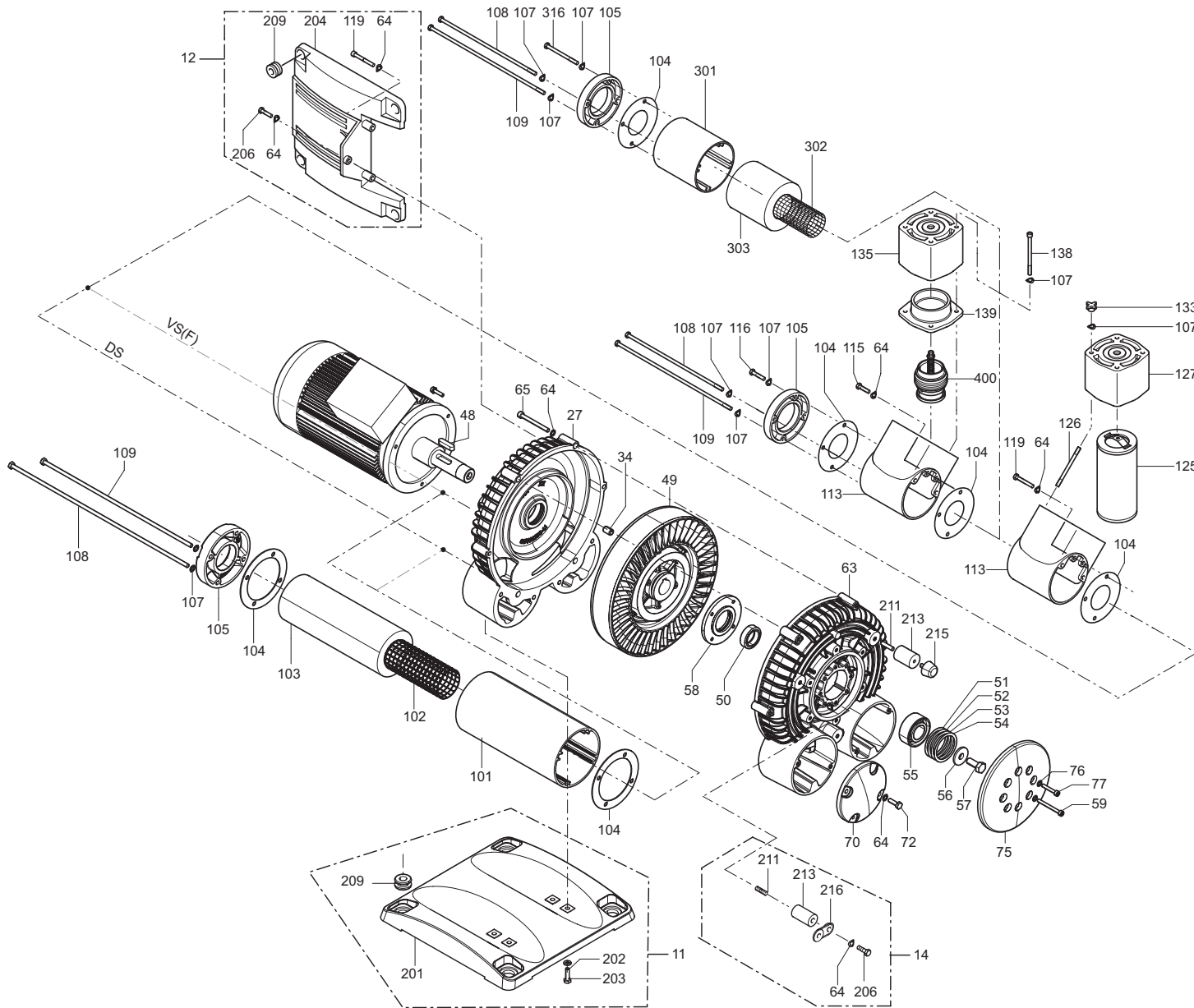

SERVICE ?

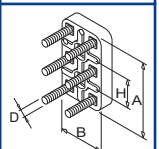
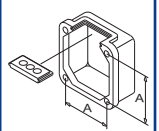
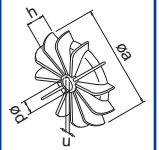
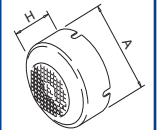
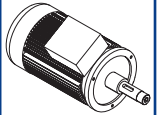

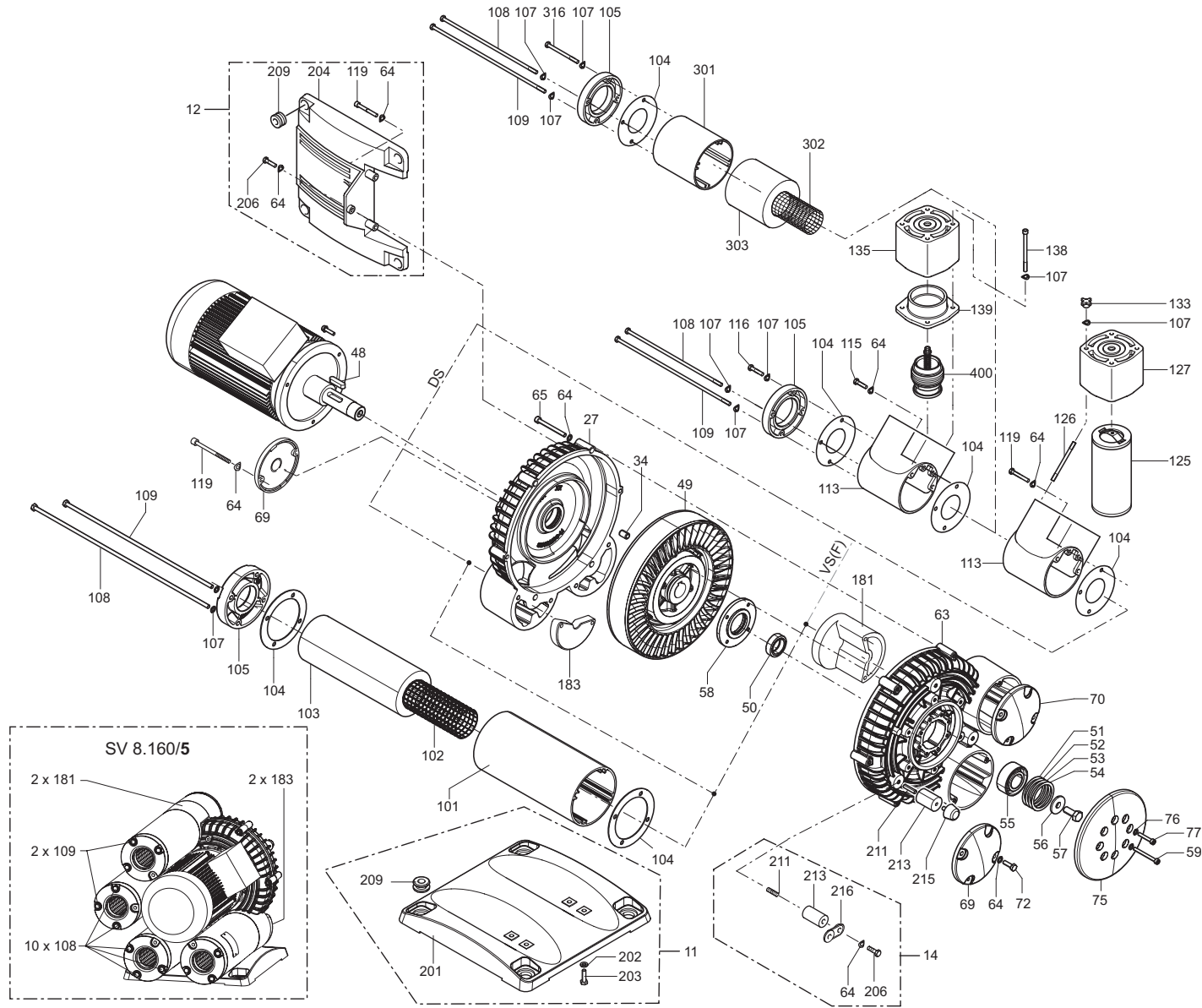

SV 8.160/2

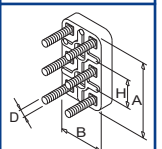
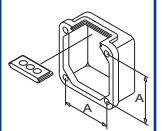
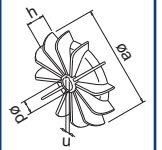
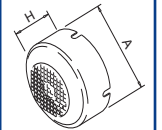
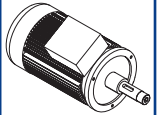

SERVICE ?



K INDEX	Pos.	Bestell Nr.	Beschreibung	
SV 8.160/X	8	570400 30300	UMBAUSATZ /1➔/2	1)
	11	515100 30200	FUSS, KOMPLETT	2)
	12	515101 30200	FUSS - SEITLICH, KOMPLETT	2)
	14	515103 30200	GERÄTEFUSS, KOMPLETT (3x)	2)
	27	000101 30300	GEHÄUSE	
	27	000111 30300	GEHÄUSE	5)
	34	064900 30200	ZENTRIERBUCHSE	
	48	947738 00000	PASSFEDER	
	49	000602 30200	LAUFRAD	
	49	000612 30200	LAUFRAD	5)
	50	013900 30200	DISTANZBUCHSE	
	51	917517 00000	DISTANZSCHEIBE 42X52X0,2	
	52	917516 00000	DISTANZSCHEIBE 42X52X0,1	
	53	911484 00000	DISTANZSCHEIBE 42X52X0,05	
	54	911483 00000	DISTANZSCHEIBE 42X52X0,025	
	55	906612 50000	WÄLZLAGER	4)
	56	016800 30200	SPANNSCHEIBE	
	57	901805 00000	WELLENENDSCHRAUBE	
	58	001104 30200	LAGERDECKEL	
	59	945313 00000	INNENSECHSKANTSCHRAUBE	
	63	000201 30300	GEHÄUSEDECKEL	
	63	000211 30300	GEHÄUSEDECKEL	5)
	64	951703 00000	FEDERSCHEIBE	
	65	945325 00000	INNENSECHSKANTSCHRAUBE	
	69	005600 30201	DECKEL	
	70	005602 30201	DECKEL	
	70	005612 30200	DECKEL	5)
	72	945222 00000	SECHSKANTSCHRAUBE	
	75	001103 30200	LAGERDECKEL	
	76	951704 00000	FEDERSCHEIBE	
	77	945315 00000	INNENSECHSKANTSCHRAUBE	
	101	007400 19600	SCHALLDÄMPFERGEHÄUSE	
	101	007410 19601	SCHALLDÄMPFERGEHÄUSE	5)
	102	907600 60000	SIEBROHR	
	103	907701 70000	DÄMPFER	
	104	907500 30200	DICHTUNG	
	105	007803 30200	GEWINDEFLANSCH	
	107	951703 00000	FEDERSCHEIBE	
	108	003803 94000	ZUGANKERSCHRAUBE	
	109	903812 01000	ZUGANKERSCHRAUBE	
	113	040100 30200	FILTERGEHÄUSE	
	113	040110 30200	FILTERGEHÄUSE	5)
	115	945321 00000	INNENSECHSKANTSCHRAUBE	
	116	945225 00000	SECHSKANTSCHRAUBE	
	119	945376 00000	INNENSECHSKANTSCHRAUBE	
	125	909568 00000	FILTERPATRONE (1x)	3)
	126	951007 00000	STIFTSCHRAUBE	
	127	040200 19700	FILTERDECKEL	
	133	921503 00000	STERNGRIFF	
	135	040201 19700	FILTERDECKEL	
	138	945373 00000	INNENSECHSKANTSCHRAUBE	
	139	016600 19601	ANSCHLUSSSTÜCK	
	139	016610 19600	ANSCHLUSSSTÜCK	5)
	181	015500 30300	REDUZIERSTÜCK	
	183	005601 30200	DECKEL	

K INDEX	Pos.	Bestell Nr.	Beschreibung	
	201	015100 30200	FUSS	
	202	947504 00000	UNTERLEGSCHLEIBE	
	203	945223 00000	SECHSKANTSCHRAUBE	
	204	015101 30200	FUSS-SEITLICH	
	206	945320 00000	INNENSECHSKANTSCHRAUBE	
	209	951906 00000	KABELTÜLLE	
	211	946944 00000	STIFTSCHRAUBE	
	213	012400 30200	ZWISCHENSTÜCK	
	215	741315 00000	GUMMIPUFFER	
	301	007401 19600	SCHALLDÄMPFERGEHÄUSE	
	301	007411 19601	SCHALLDÄMPFERGEHÄUSE	5)
	302	907600 70100	SIEBROHR	
	303	907702 10000	DÄMPFER	
	316	903803 01000	ZUGANKERSCHRAUBE	
	400.1	733700 99581	VENTILEINSATZ, < 0,17BAR	
	400.2	733701 99581	VENTILEINSATZ, < 0,28BAR	
	400.3	733702 99581	VENTILEINSATZ, < 0,42BAR	

1) Pos.: 64, 69, 119, 181, 183
2) variantenabhängige Bauteile
3) erforderliche Bestellmenge / Wartung (F / DSF / VSF)
4) Lager sind mit Spezialfett gefüllt. Nur durch Original der Firma Gebr. Becker ersetzen.
5) nur bei Ausführung mit Korrosionsschutz (SV 8.160/X-05)

K INDEX	Pos.	Ident No.	Description	
SV 8.160/X	8	570400 30300	CONVERSION SET /1 → /2	1)
	11	515100 30200	FOOT, COMPLETE	2)
	12	515101 30200	FOOT - LATERAL, COMPLETE	2)
	14	515103 30200	FOOT, COMPLETE (3x)	2)
	27	000101 30300	PUMP HOUSING	
	27	000111 30300	PUMP HOUSING	5)
	34	064900 30200	CENTRING BUSH	
	48	947738 00000	KEY	
	49	000602 30200	IMPELLER WHEEL	
	49	000612 30200	IMPELLER WHEEL	5)
	50	013900 30200	SPACER SLEEVE	
	51	917517 00000	SPACER 25X33X0,2	
	52	917516 00000	SPACER 25X33X0,1	
	53	911484 00000	SPACER 25X33X0,05	
	54	911483 00000	SPACER 25X33X0,025	
	55	906612 50000	ANTIFRICTION BEARING	4)
	56	016800 30200	IDLER	
	57	901805 00000	SHAFT END SCREW	
58	001104 30200	BEARING CAP		
59	945313 00000	HEX-HEAD SCREW		
63	000201 30300	HOUSING LID		
63	000211 30300	HOUSING LID	5)	
64	951703 00000	LOCKING WASHER		
65	945325 00000	HEX-HEAD SCREW		
69	005600 30201	COVER		
70	005602 30201	LID		
70	005612 30200	LID	5)	
72	945222 00000	HEX HEAD SCREW		
75	001103 30200	BEARING CAP		
76	951704 00000	LOCKING WASHER		
77	945315 00000	SOCKET HEAD SCREW		
101	007400 19600	SILENCER HOUSING		
101	007410 19601	SILENCER HOUSING	5)	
102	907600 60000	STRAINER TUBE		
103	907701 70000	SILENCER SPONGE		
104	907500 30200	GASKET		
105	007803 30200	SCREWED FLANGE		
107	951703 00000	LOCKING WASHER		
108	003803 94000	ANCHORING SCREW		
109	903812 01000	ANCHORING SCREW		
113	040100 30200	FILTER HOUSING		
113	040110 30200	FILTER HOUSING	5)	
115	945321 00000	SOCKET HEAD SCREW		
116	945225 00000	HEX-HEAD SCREW		
119	945376 00000	SOCKET HEAD SCREW		
125	909568 00000	FILTER CARTRIDGE (1x)	3)	
126	951007 00000	STUD		
127	040200 19700	FILTER COVER		
133	921503 00000	STAR GRIP		
135	040201 19700	FILTER COVER		
138	945373 00000	SOCKET HEAD SCREW		
139	016600 19601	CONNECTING PIECE		
139	016610 19600	CONNECTING PIECE	5)	
181	015500 30300	REDUCING PIECE		
183	005601 30200	COVER		

K INDEX	Pos.	Ident No.	Description	
	201	015100 30200	FOOT	
	202	947504 00000	WASHER	
	203	945223 00000	HEX-HEAD SCREW	
	204	015101 30200	FOOT	
	206	945320 00000	SOCKET HEAD SCREW	
	209	951906 00000	RUBBER BUSHING	
	211	946944 00000	STUD	
	213	012400 30200	INTERMEDIATE PIECE	
	215	741315 00000	RUBBER BUFFER	
	301	007401 19600	SILENCER HOUSING	
	301	007411 19601	SILENCER HOUSING	5)
	302	907600 70100	STRAINER TUBE	
	303	907702 10000	SILENCER MATERIAL	
	316	903803 01000	ANCHORING SCREW	
	400.1	733700 99581	VALVE CORE, < 0,17BAR	
	400.2	733701 99581	VALVE CORE, < 0,28BAR	
	400.3	733702 99581	VALVE CORE, < 0,42BAR	

1) Pos.: 64, 69, 119, 181, 183
2) variant-dependent components
3) necessary order quantity / maintenance (F / DSF / VSF)
4) Bearings are filled with special grease. Only be replaced by Gebrüder Beckers original.
5) only for devices with corrossions protection (SV 8.160/X-05)

K INDICE	Pos.	No. Identification	Designation	FR	
SV 8.160/X	8	570400 30300	ÉQUIPEMENT DE CONVERSION /1➔/2	1)	
	11	515100 30200	PIED, COMPLET	2)	
	12	515101 30200	PIED - LATÉRAL, COMPLET	2)	
	14	515103 30200	PIED, COMPLET (3x)	2)	
	27	000101 30300	CARTER		
	27	000111 30300	CARTER	5)	
	34	064900 30200	BAGUE DE CENTRAGE		
	48	947738 00000	CLAVETTE		
	49	000602 30200	ROUE À AUBAGES		
	49	000612 30200	ROUE À AUBAGES	5)	
	50	013900 30200	DOUILLE D'ÉCARTEMENT		
	51	917517 00000	DISQUE AJUSTAGE 25X33X0,2		
	52	917516 00000	DISQUE AJUSTAGE 25X33X0,1		
	53	911484 00000	DISQUE AJUSTAGE 25X33X0,05		
	54	911483 00000	DISQUE AJUSTAGE 25X33X0,025		
	55	906612 50000	ROULEMENT A BILLES	4)	
	56	016800 30200	POULIE DE TENSION		
	57	901805 00000	VIS SIX-PANS		
58	001104 30200	CHAPEAU DE PALIER			
59	945313 00000	VIS HEXAGONALE INTERNE			
63	000201 30300	COUVERCLE DE CARTER			
63	000211 30300	COUVERCLE DE CARTER	5)		
64	951703 00000	RONDELLE À RESSORT			
65	945325 00000	VIS HEXAGONALE INTERNE			
69	005600 30201	COUVERCLE			
70	005602 30201	COUVERCLE			
70	005612 30200	COUVERCLE	5)		
72	945222 00000	VIS SIX-PANS			
75	001103 30200	CHAPEAU DE PALIER			
76	951704 00000	RONDELLE À RESSORT			
77	945315 00000	VIS HEXAGONALE INTERNE			
101	007400 19600	CORPS DE LA SILENCIEUX			
101	007410 19601	CORPS DE LA SILENCIEUX	5)		
102	907600 60000	GRILLE POUR SILENCIEUX			
103	907701 70000	MOUSSE POUR SILENCIEUX			
104	907500 30200	JOINT			
105	007803 30200	BRIDE FILETÉE			
107	951703 00000	RONDELLE À RESSORT			
108	003803 94000	VIS D'ANCRAGE			
109	903812 01000	VIS D'ANCRAGE			
113	040100 30200	BOITE POUR FILTRE			
113	040110 30200	BOITE POUR FILTRE	5)		
115	945321 00000	VIS HEXAGONALE INTERNE			
116	945225 00000	VIS HEXAGONALE			
119	945376 00000	VIS HEXAGONALE INTERNE			
125	909568 00000	CARTOUCHE FILTRANTE (1x)	3)		
126	951007 00000	PRISONNIER			
127	040200 19700	COUVERCLE DU FILTRE			
133	921503 00000	POIGNEE-ETOILE			
135	040201 19700	COUVERCLE DU FILTRE			
138	945373 00000	VIS HEXAGONALE INTERNE			
139	016600 19601	PIECE RACCORD			
139	016610 19600	PIECE RACCORD	5)		
181	015500 30300	PIECE DE REDUCTION			
183	005601 30200	COUVERCLE			

K INDICE	Pos.	No. Identification	Designation	FR	
	201	015100 30200	PIED		
	202	947504 00000	RONDELLE		
	203	945223 00000	VIS HEXAGONALE		
	204	015101 30200	PIED-LATÉRAL		
	206	945320 00000	VIS HEXAGONALE INTERNE		
	209	951906 00000	PROTECTION EN CAOUTCHOUC		
	211	946944 00000	PRISONNIER		
	213	012400 30200	PLAQUE INTERMEDIARE		
	215	741315 00000	AMORTISSEUR EN CAOUTCHOUC		
	301	007401 19600	CARCASSE SILENCIEUX		
	301	007411 19601	CARCASSE SILENCIEUX	5)	
	302	907600 70100	TUYAU-TAMIS		
	303	907702 10000	MATERIAL POUR SILENCIEUX		
	316	903803 01000	VIS		
	400.1	733700 99581	SOUPAPE, < 0,17BAR		
	400.2	733701 99581	SOUPAPE, < 0,28BAR		
	400.3	733702 99581	SOUPAPE, < 0,42BAR		

1) Pos.: 64, 69, 119, 181, 183
2) composants variante-dependantes
3) quantité nécessaire / entretien (F / DSF / VSF)
4) Les roulements sont remis d'une graisse spéciale. N'utiliser que de la graisse d'origine de Gebrüder Becker pour la remplacer
5) uniquement pour les versions avec prot. contre la corrosion (SV 8.160/X-05)

K INDICE	Pos.	No. Identificazione	Designazione	IT	
SV 8.160/X	8	570400 30300	ATTREZZATURA PER LA TRASFORMAZIONE /1 → /2	1)	
	11	515100 30200	PIEDE, COMPLETO	2)	
	12	515101 30200	PIEDE - LATERALE, COMPLETO	2)	
	14	515103 30200	PIEDE, COMPLETO (3x)	2)	
	27	000101 30300	CARCASSA		
	27	000111 30300	CARCASSA	5)	
	34	064900 30200	BOCCOLA DI CENTRAGGIO		
	48	947738 00000	CHIAVETTA		
	49	000602 30200	RUOTA A PALETTE		
	49	000612 30200	RUOTA A PALETTE	5)	
	50	013900 30200	ANELLO DISTANZIATORE		
	51	917517 00000	DISCO GIUOCO 25X33X0,2		
	52	917516 00000	DISCO GIUOCO 25X33X0,1		
	53	911484 00000	DISCO GIUOCO 25X33X0,05		
	54	911483 00000	DISCO GIUOCO 25X33X0,025		
	55	906612 50000	CUSCINETTO A SFERA	4)	
	56	016800 30200	PULEGGIA DI TENSIONE		
	57	901805 00000	VITE ESAGONALE		
58	001104 30200	CAPPELLO DEL CUSCINETTO			
59	945313 00000	VITE ESAGONALE INTERNA			
63	000201 30300	COPERCHIO DELLA CARCASSA			
63	000211 30300	COPERCHIO DELLA CARCASSA	5)		
64	951703 00000	DISCO A MOLLA			
65	945325 00000	VITE ESAGONALE INTERNA			
69	005600 30201	COPERCHIO			
70	005602 30201	COPERCHIO			
70	005612 30200	COPERCHIO	5)		
72	945222 00000	VITE ESAGONALE			
75	001103 30200	CAPPELLO DEL CUSCINETTO			
76	951704 00000	RONDELLA A MOLLA			
77	945315 00000	VITE ESAGONALE INTERNA			
101	007400 19600	CARCASSA SILENZIATORE			
101	007410 19601	CARCASSA SILENZIATORE	5)		
102	907600 60000	TUBO-CRIVELLO			
103	907701 70000	MATERIALE PER SILENZIATORE			
104	907500 30200	GIUNTO			
105	007803 30200	FLANGIA FILETTATA			
107	951703 00000	RONDELLA A MOLLA			
108	003803 94000	CHIAVARDA D'ANCORAGGIO			
109	903812 01000	CHIAVARDA D'ANCORAGGIO			
113	040100 30200	CONTENITORE FILTRO A CARTUCCIA			
113	040110 30200	CONTENITORE FILTRO A CARTUCCIA	5)		
115	945321 00000	VITE ESAGONALE INTERNA			
116	945225 00000	VITE ESAGONALE			
119	945376 00000	VITE ESAGONALE INTERNA			
125	909568 00000	CARTUCCIA FILTRO (1x)	3)		
126	951007 00000	L'ASTA A VITE			
127	040200 19700	COPERCHIO FILTRO			
133	921503 00000	MANOPOLA A CROCIERA			
135	040201 19700	COPERCHIO FILTRO			
138	945373 00000	VITE ESAGONALE INTERNA			
139	016600 19601	PEZZI RACCORDI			
139	016610 19600	PEZZI RACCORDI	5)		
181	015500 30300	GIUNTO DI REDUZIONE			
183	005601 30200	COPERCHIO			

K INDICE	Pos.	No. Identificazione	Designazione	IT	
	201	015100 30200	PIEDE		
	202	947504 00000	RONDELLA		
	203	945223 00000	VITE ESAGONALE		
	204	015101 30200	PIEDE-LATERALE		
	206	945320 00000	VITE ESAGONALE INTERNA		
	209	951906 00000	PROTEZIONE IN GOMMA		
	211	946944 00000	L'ASTA A VITE		
	213	012400 30200	PIASTRA INTERMEDIA		
	215	741315 00000	AMMORTIZZATORE IN GOMMA		
	301	007401 19600	CARCASSA SILENZIATORE		
	301	007411 19601	CARCASSA SILENZIATORE	5)	
	302	907600 70100	TUBO-CRIVELLO		
	303	907702 10000	MATERIALE PER SILENZIATORE		
	316	903803 01000	VITE		
	400.1	733700 99581	VALVOLA, < 0,17BAR		
	400.2	733701 99581	VALVOLA, < 0,28BAR		
	400.3	733702 99581	VALVOLA, < 0,42BAR		

1) Pos.: 64, 69, 119, 181, 183
2) componenti variante-dipendenti
3) quantità di ordinazione necessari / manutenzione (F / DSF / VSF)
4) I cuscinetti sono riempiti di grasso speciale. Eseguire il reingrassaggio solo con grasso originale della Gebrüder Becker.
5) solo per le versioni con protezione anti-corrosione (SV 8.160/X-05)

K INDICE	Pos.	No. De pedido	Descripción	ES	
					
SV 8.160/X	8	570400 30300	EQUIPO PARA LA CONVERSIÓN /1➔/2	1)	
	11	515100 30200	PIE, COMPLETO	2)	
	12	515101 30200	PIE - LATERAL, COMPLETO	2)	
	14	515103 30200	PIE, COMPLETO (3x)	2)	
	27	000101 30300	CARCASA		
	27	000111 30300	CARCASA	5)	
	34	064900 30200	MANGUITO DE CENTRADO		
	48	947738 00000	LENGÜETA DE AJUSTE		
	49	000602 30200	RUEDA CORREDERA		
	49	000612 30200	RUEDA CORREDERA	5)	
	50	013900 30200	CASQUILLO DISTANCIADOR		
	51	917517 00000	ARANDELA DISTANCIADORA 25X33X0,2		
	52	917516 00000	ARANDELA DISTANCIADORA 25X33X0,1		
	53	911484 00000	ARANDELA DISTANCIADORA 25X33X0,05		
	54	911483 00000	ARANDELA DISTANCIADORA 25X33X0,025		
	55	906612 50000	COJINETE DE RODAMIENTO	4)	
	56	016800 30200	POLEA TENSORA		
	57	901805 00000	TORNILLO DE CABEZA HEXAGONAL		
58	001104 30200	TAPA DEL COJINETE			
59	945313 00000	TORNILLO DE CABEZA HEXAGONAL			
63	000201 30300	CUBIERTA DE CARCASA			
63	000211 30300	CUBIERTA DE CARCASA	5)		
64	951703 00000	ARANDELA ELÁSTICA			
65	945325 00000	TORNILLO HEXAGONAL INTERIOR			
69	005600 30201	TAPA			
70	005602 30201	TAPA			
70	005612 30200	TAPA	5)		
72	945222 00000	TORNILLO DE CABEZA HEXAGONAL			
75	001103 30200	TAPA DEL COJINETE			
76	951704 00000	ARANDELA DE RESORTE			
77	945315 00000	TORNILLO HEXAGONAL INTERIOR			
101	007400 19600	CARCASA DE SILENCIADOR			
101	007410 19601	CARCASA DE SILENCIADOR	5)		
102	907600 60000	TUBO DE CRIBA			
103	907701 70000	AMORTIGUADOR			
104	907500 30200	JUNTA			
105	007803 30200	BRIDA ROSCADA			
107	951703 00000	ARANDELA DE RESORTE			
108	003803 94000	TORNILLO DE ANCLAJE			
109	903812 01000	TORNILLO DE ANCLAJE			
113	040100 30200	CARCASA DE FILTRO			
113	040110 30200	CARCASA DE FILTRO	5)		
115	945321 00000	TORNILLO HEXAGONAL INTERIOR			
116	945225 00000	TORNILLO DE CABEZA HEXAGONAL			
119	945376 00000	TORNILLO HEXAGONAL INTERIOR			
125	909568 00000	CARTUCHO (1x)	3)		
126	951007 00000	ESPÁRRAGO			
127	040200 19700	FILTRO TAPA			
133	921503 00000	EMPUÑADURA DE ESTRELLA			
135	040201 19700	TAPA DE FILTRO			
138	945373 00000	TORNILLO HEXAGONAL INTERIOR			
139	016600 19601	PIEZA DE EMPALME			
139	016610 19600	PIEZA DE EMPALME	5)		
181	015500 30300	PIEZA DE REDUCCIÓN			
183	005601 30200	TAPA			

K INDICE	Pos.	No. De pedido	Descripción	ES	
					
	201	015100 30200	PIE		
	202	947504 00000	ARANDELA		
	203	945223 00000	TORNILLO DE CABEZA HEXAGONAL		
	204	015101 30200	PIE DE APARATO - LATERAL		
	206	945320 00000	TORNILLO HEXAGONAL INTERIOR		
	209	951906 00000	BOQUILLA DE CABLE		
	211	946944 00000	ESPÁRRAGO		
	213	012400 30200	PIEZA INTERMEDIA		
	215	741315 00000	AMORTIGUADOR DE GOMA		
	301	007401 19600	CARCASA DE SILENCIADOR		
	301	007411 19601	CARCASA DE SILENCIADOR	5)	
	302	907600 70100	TUBO DE CRIBA		
	303	907702 10000	AMORTIGUADOR PANTARIN		
	316	903803 01000	TORNILLO TIRANTE		
	400.1	733700 99581	VÁLVULA, < 0,17BAR		
	400.2	733701 99581	VÁLVULA, < 0,28BAR		
	400.3	733702 99581	VÁLVULA, < 0,42BAR		

1) Pos.: 64, 69, 119, 181, 183
2) componentes variante-dependientes
3) cantidad necesario / mantenimiento (F / DSF / VSF)
4) Los rodamientos estan rellenos de grasa especial. Sólo reemplazar por grasa original de Gebrüder Becker
5) sólo para las versiones con protección contra la corrosión (SV 8.160/X-05)