

**DXLF / VXLF 2.200**  
**DXLF / VXLF 2.250**  
**DXLF / VXLF 2.250**

**SERVICE**

D-42279 Wuppertal www.becker-international.com		year	XXXX
No. A		Index Variante	
type	VXLF 2.250-XX	Made in	Germany
frequency	XXXX	Hz	
speed	XXXX	min <sup>-1</sup>	
power required	XXXX	kW	
inlet capacity	XXXX	m <sup>3</sup> /h	
pressure +	XXXX	mbar	
vacuum -	XXXX	mbar	

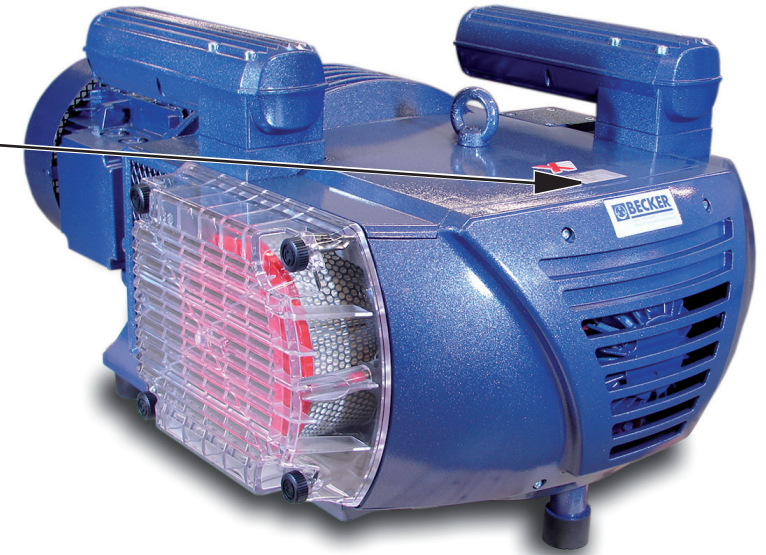

**Ersatzteilliste**  
**Spare parts list**  
**Liste de pièces de rechange**  
**Listino pezzi di ricambio**  
**Lista de piezas de recambio**  
**Lista de peças sobresselentes**  
**Reserveonderdelenlijst**  
**Atsarginių dalių sąrašas**  
**Varuosad nimekirja**  
**Rezerves daļu saraksts**

**Reservedelsliste**  
**Reservdelslista**  
**Varaosuettelotelo**  
**Reservedelsliste**  
**Wykaz części zamiennych**  
**Tartalékalkatrész lista**  
**Seznam náhradních dílů**  
**Seznam nadomestnih delov**  
**Zoznam náhradných dielov**  
**Rezervni dijelovi popis**

**Lista pieselor de schimb**  
**Páirteanna spártha liosta**  
**Κατάλογος ανταλλακτικών**  
**Yedek parça listesi**  
**Списък на резервните части**  
**Перечень запасных частей**  
**スペアパーツリスト**  
**예비 부품 목록**  
**备用零件目录**

**SERVICE**  
[www.becker-international.com](http://www.becker-international.com)  
**Sales and service network**

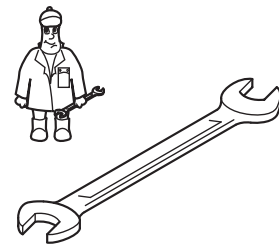

**Wartung**  
**Maintenance**  
**Entretien**  
**Manutenzione**  
**Mantenimiento**



Pos.	Menge <sup>2)</sup> Quantity Quantité Quantità Cantidad	Bestell-Nr. Ident No. No. Identification No. Identificazione No. de pedido	Bezeichnung Description Designation Designazione Descripción
□	1	549000 52200	Dichtungssatz, Complete set of seals, Jeu de joints, Kit di guarnizioni, Junta completa
108	SATZ/KIT	901325 00005	Schieber, Rotor Vane, Palette, Empujador
203	1	909512 00000	Filterpatrone, Filter cartridge, Cartouche Filtrante, Cartuccia filtro, Cartucho de filtro
412	2 <sup>3)</sup>	909510 00000	Filterpatrone, Filter cartridge, Cartouche Filtrante, Cartuccia filtro, Cartucho de filtro
520	1 <sup>4)</sup>	909541 00000	Staubabscheider, Séparateur de poussière, Separatore di polveri, Separador de polvo

<sup>2)</sup> erforderliche Bestellmenge / necessary order quantity / quantité nécessaire / quantità di ordinazione necessari / cantidad necesario  
<sup>3)</sup> nur für VXLF 2.250/X SK / only for VXLF 2.250/X SK / seulement pour VXLF 2.250/X SK / solo per VXLF 2.250/X SK / sólo para VXLF 2.250/X SK  
<sup>4)</sup> nur für Pumpen mit integriertem Staubabscheider / only for pumps with integrated dust separator / seulement pour les pompes avec séparateur de poussière / solo per le pompe con separatore polvere / sólo para bombas con separador de polvo

Standard  
 ( )XLF 2.200  
 ( )XLF 2.250

Variante

- ①  
**DXLF 2.250 K**  
**DVXLF 2.250 K**  
 - mit Kühler  
 - with cooler  
 - avec refroidisseur  
 - con raffreddamento  
 - con refrigerador
- ②  
**VXLF 2.250 SK**  
 - mit Spülkühler  
 - with special cooler  
 - avec refroidisseur spécial  
 - con radiatore speciale  
 - con refrigerador especial
- ③  
**DVXLF KSK**  
 - mit Kühler und Spülkühler  
 - with special cooler  
 - avec refroidisseur spécial  
 - con radiatore speciale  
 - con refrigerador especial
- ④  
**VXLF 2.250/0-400**  
**DXLF 2.250/0-400**  
 - mit Frequenzumrichter  
 - with frequency convertor  
 - avec convertisseur de fréquence  
 - con convertitore di frequenza  
 - con convertidor de frecuencia

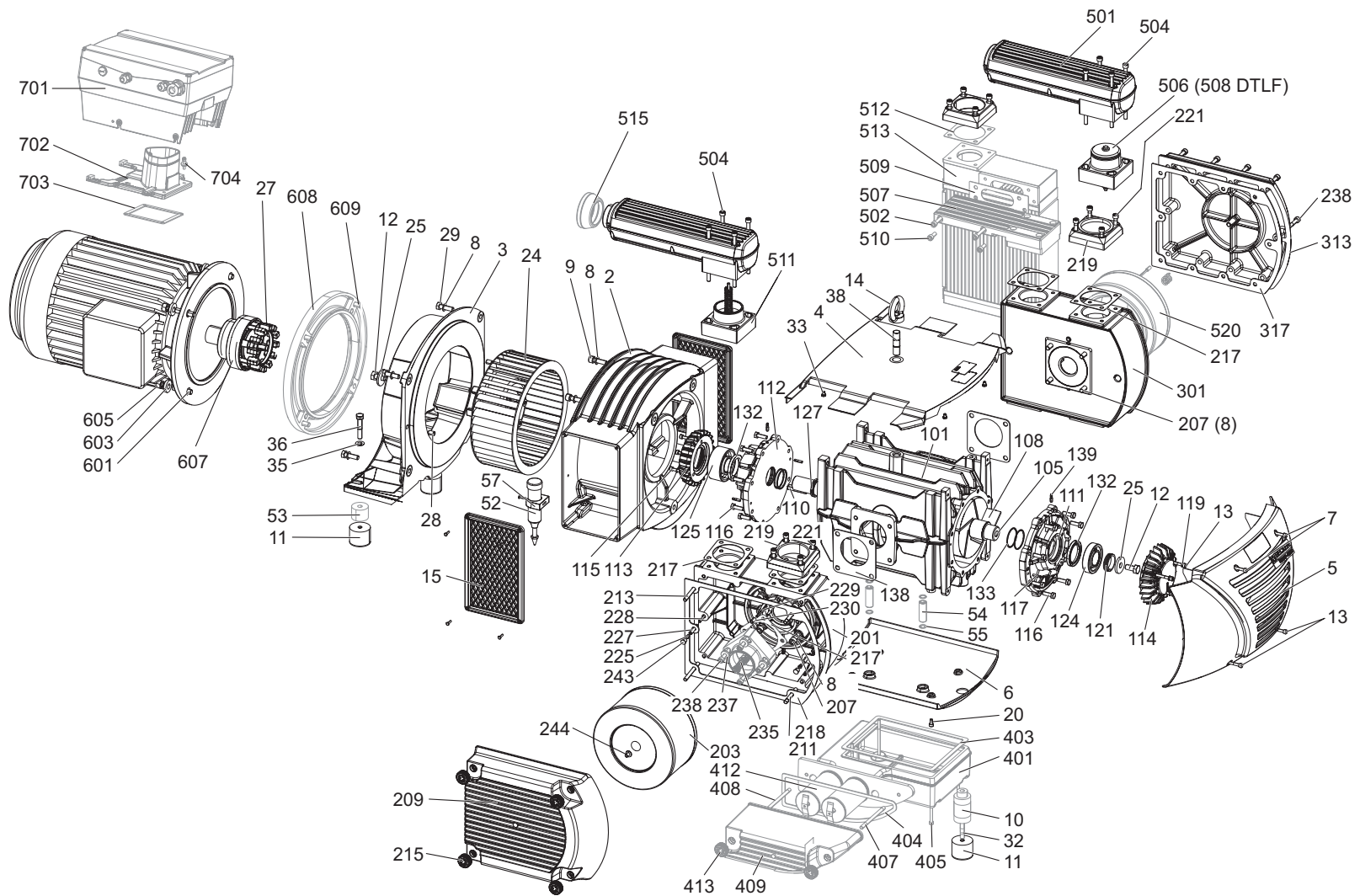

SERVICE ?

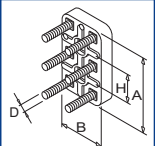
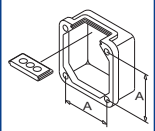
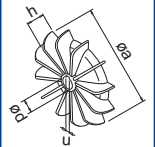
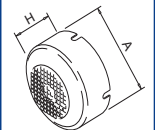
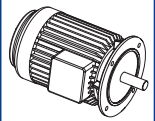

A INDEX	Pos.	Bestell Nr.	Beschreibung	
( ) XLF 2.200-2.250	■	549000 52200	DICHTUNGSSATZ <sup>1)</sup>	
	2	053200 52200	LATERNE	
	3	014905 52200	MOTORFLANSCH (DXLF+DVXLF)	
	3	014906 52200	MOTORFLANSCH (VXLF)	
	4	918302 52200	HAUBE (VXLF)	
	4	918303 52200	HAUBE (DXLF)	
	4	918304 52200	HAUBE (DVXLF)	
	5	920800 52200	LUFTLEITHAUBE	
	6	918300 52200	HAUBE	
	7	945324 00000	INNENSECHSKANTSCHRAUBE, DIN912 M6X55	
	8	951710 00000	FEDERSCHEIBE	
	9	945351 00000	INNENSECHSKANTSCHRAUBE, DIN912 M10X35	
	10	011400 52200	DISTANZSTÜCK	
	11	741303 00000	GUMMI-PUFFER	
	12	945270 00000	WELLENENDSCHRAUBE	
	13	945363 00000	INNENSECHSKANTSCHRAUBE, DIN912 M6X40	
	14	951605 00000	RINGMUTTER, M16	
	15	960700 52200	LÜFTERHAUBE	
	20	901809 00000	INNENSECHSKANTSCHRAUBE, DIN912 M6X16	
	24	544503 22200	KUPPLUNGSHÄLFTE MIT VENTILATOR	
	25	949409 00000	UNTERLEGSCHLEIFE	
27	902200 20000	KUPPLUNGS-RING		
28	064900 30200	ZENTRIERBUCHSE		
29	945238 00000	SECHSKANTSCHRAUBE, DIN933 M10X35		
32	946930 00000	STIFTSCHRAUBE, DIN939 M10X60		
33	951925 00000	GUMMIFORMTEIL		
34	950353 00000	KEGELPFANNE, DIN6319-12-G		
35	950354 00000	KUGELSCHLEIFE, DIN6319-10,5-C		
36	945237 00000	SECHSKANTSCHRAUBE, DIN933 M10X30		
38	946962 00000	STIFTSCHRAUBE, DIN939 M16X40		
52	743303 00000	SPEZIALFETT (FETTPRESSE, 50g)		
57	967059 00000	HALTER		
101	000100 52200	GEHÄUSE		
105	020000 51100	KOLBEN		
108	901325 00005	KOHLESCHIEBER - SATZ <sup>2)</sup>		
110	947812 00000	PASSFEDER, DIN6885 B10X8X50		
111	000700 52200	SEITENDECKEL		
112	000800 52200	SEITENDECKEL		
113	001101 52200	LAGERDECKEL		
114	001000 52200	LAGERDECKEL		
115	945321 00000	INNENSECHSKANTSCHRAUBE, DIN912 M6X25		
116	945230 00000	SECHSKANTSCHRAUBE, DIN933 M8X25		
117	948742 00000	PASSKERBSTIFT, DIN1472 5X20		
119	951703 00000	FEDERSCHLEIFE, DIN137 A6		
121	068900 91000	FETT-TRANSPORTRING		
124	906649 00000	WÄLZLAGER		
125	906617 20000	WÄLZLAGER		
127	511400 22200	DISTANZSCHLEIFENSATZ		
132	906577 00000	WELLENDICHTRING, DF45X62X7		
133	911310 00000	DICHTUNGSSCHLAUCH, 45X2		
138	003100 52200	DICHTUNG		
139	008102 52200	SCHLAUCHTUELLE		
201	040100 52200	FILTERGEHÄUSE (VXLF+DVXLF)		
201	040102 52200	FILTERGEHÄUSE (DXLF)		
203	909512 00000	PATRONE (1x) <sup>2)</sup>		
207	945350 00000	INNENSECHSKANTSCHRAUBE, DIN912 M10X30		
209	040200 52200	FILTERDECKEL		
211	946919 00000	STIFTSCHRAUBE, DIN939 M8X50		
213	946976 00000	STIFTSCHRAUBE, DIN939 M8X65		
215	921501 50000	HANDGRIFF		

A INDEX	Pos.	Bestell Nr.	Beschreibung	
	217	007900 22200	DICHTUNG	
	218	008900 52200	DICHTUNG	
	219	007801 52200	GEWINDEFLENSCH	
	221	945333 00000	INNENSECHSKANTSCHRAUBE, DIN912 M8X35	
	225	949001 00000	SCHMIERNIPPEL, DIN3405	
	227	008103 52200	SCHLAUCHTÜLLE	
	228	742601 52200	SCHMIERSCHLAUCH	
	229	952006 00000	SPANNHÜLSE	
	230	042600 10100	SCHLAUCH	
	235	535003 99619	RÜCKSCHLAGVENTIL - OPTIONAL	
	238	945336 00000	INNENSECHSKANTSCHRAUBE, DIN912 M8X50	
	243	912888 00000	STOPFEN	
	244	912801 00000	GUMMIFORMTEIL	
	301	040101 52200	FILTERGEHÄUSE (VXLF)	
	301	040103 52200	FILTERGEHÄUSE (DXLF+DVXLF)	
	313	040201 52200	FILTERDECKEL	
	317	000300 52200	DICHTUNG	
	501	539801 52200	SCHALLDÄMPFER	
	504	945346 00000	INNENSECHSKANTSCHRAUBE, DIN912 M8X140	
	506	534000 99619	ABBLASEVENTIL (VXLF)	
	508	534002 99619	DRUCKSICHERHEITVENTIL	
	511	535001 99619	VAKUUMSICHERHEITVENTIL	
	515	734900 99522	KAPPE - OPTIONAL	
	520	909541 00000	STAUBABSCHLEIDER - OPTIONAL	
	601	946945 00000	STIFTSCHRAUBE, DIN939 M12X35	
	603	949455 00000	U-SCHLEIFE, DIN7349	
	605	947107 00000	SECHSKANTMUTTER, DIN934 M12	
	607	902100 22200	MOTORKUPPLUNG, Ø 38mm (B5/300)	
	607	902101 22200	MOTORKUPPLUNG, Ø 42mm (5.5...11kW)	
	607	902102 22200	MOTORKUPPLUNG, Ø 48mm (15kW)	
	608	003600 52200	ZWISCHENFLANSCH (B5/300)	
	609	945349 00000	INNENSECHSKANTSCHRAUBE, DIN912 M10X25	

<sup>1)</sup> Dichtungssatz - 54900052200 - Pos.: 133, 138, 217, 218, 317  
<sup>2)</sup> erforderliche Bestellmenge / Wartung

A INDEX	Pos.	Ident No.	Description	
) XLF 2.200-2.250	■	549000 52200	<b>SET OF SEALS <sup>1)</sup></b>	
	2	053200 52200	CONNECTION FLANGE	
	3	014905 52200	MOTORFLANGE ( <b>DXLF+DVXLF</b> )	
	3	014906 52200	MOTORFLANGE ( <b>VXLF</b> )	
	4	918302 52200	COVERING HOOD ( <b>VXLF</b> )	
	4	918303 52200	COVERING HOOD ( <b>DXLF</b> )	
	4	918304 52200	COVERING HOOD ( <b>DVXLF</b> )	
	5	920800 52200	AIR GUIDE COVER RING	
	6	918300 52200	COVERING HOOD	
	7	945324 00000	SOCKET HEAD SCREW	
	8	951710 00000	SPRING DISC	
	9	945351 00000	SOCKET HEAD SCREW	
	10	011400 52200	DISTANCE-DISC	
	11	741303 00000	RUBBER BUFFER	
	12	945270 00000	SHAFT END BOLD	
	13	945363 00000	SOCKET HEAD SCREW	
	14	951605 00000	RING UNIT	
	15	960700 52200	VENTILATOR HOOD	
	20	901809 00000	SOCKET HEAD SCREW	
	24	544503 22200	COUPLING WITH FAN	
25	949409 00000	WASHER		
27	902200 20000	COUPLING RING		
28	064900 30200	CENTRING BUSH		
29	945238 00000	HEX-HEAD SCREW		
32	946930 00000	STUD		
33	951925 00000	RUBBER ELEMENT		
34	950353 00000	DISHED WASHER		
35	950354 00000	SPHERICAL SEAT WASHER		
36	945237 00000	HEX-HEAD SCREW		
38	946962 00000	STUD		
52	743303 00000	<b>SPECIAL GREASE</b> (GREASE PRESS, 50g)		
57	967059 00000	HOLDER		
101	000100 52200	PUMP BODY		
105	020000 51100	ROTOR		
108	901325 00005	<b>ROTOR VANES - KIT <sup>2)</sup></b>		
110	947812 00000	KEY		
111	000700 52200	LID RIGHT		
112	000800 52200	LID LEFT		
113	001101 52200	BEARING COVER		
114	001000 52200	BEARING COVER		
115	945321 00000	SOCKET HEAD SCREW		
116	945230 00000	HEX-HEAD SCREW		
117	948742 00000	STRAIGHT PIN		
119	951703 00000	SPRING DISC		
121	068900 91000	GREASE DISTRIBUTION WASHER		
124	906649 00000	BALL BEARING		
125	906617 20000	BALL BEARING		
127	511400 22200	SPACER SET		
132	906577 00000	SHAFT-SEALING RING		
133	911310 00000	SEAL		
138	003100 52200	GASKET		
139	008102 52200	CONDUIT-GREASE		
201	040100 52200	FILTER HOUSING ( <b>VXLF+DVXLF</b> )		
201	040102 52200	FILTER HOUSING ( <b>DXLF</b> )		
203	909512 00000	<b>FILTER CARTRIDGE</b> (1x) <sup>2)</sup>		
207	945350 00000	SOCKET HEAD SCREW		
209	040200 52200	FILTER COVER		
211	946919 00000	STUD		
213	946976 00000	STUD		
215	921501 50000	HANDLE		

A INDEX	Pos.	Ident No.	Description	
	217	007900 22200	GASKET	
	218	008900 52200	GASKET	
	219	007801 52200	CONNECTING FLANGE	
	221	945333 00000	SOCKET HEAD SCREW	
	225	949001 00000	GREASE NIPPLE	
	227	008103 52200	HOSE CONNECTOR	
	228	742601 52200	LUBRICATION LINE	
	229	952006 00000	FIXING SLEEVE	
	230	042600 10100	FLEXIBLE HOSE	
	235	535003 99619	NON RETURN VALVE - OPTIONAL	
	238	945336 00000	SOCKET HEAD SCREW	
	243	912888 00000	PLUG	
	244	912801 00000	RUBBER ELEMENT	
	301	040101 52200	FILTER HOUSING ( <b>VXLF</b> )	
	301	040103 52200	FILTER HOUSING ( <b>DXLF+DVXLF</b> )	
	313	040201 52200	FILTER COVER	
	317	000300 52200	GASKET	
	501	539801 52200	SILENCER	
	504	945346 00000	SOCKET HEAD SCREW	
	506	534000 99619	BLOW-OFF VALVE	
	508	534002 99619	PRESSURE RELIEF VALVE	
	511	535001 99619	VACUUM RELIEF VALVE	
	515	734900 99522	CAP - OPTIONAL	
	520	909541 00000	<b>DUST SEPARATOT</b> - OPTIONAL	
	601	946945 00000	STUD	
	603	949455 00000	WASHER	
	605	947107 00000	HEX. NUT	
	607	902100 22200	COUPLING MOTOR SIDE, Ø 38mm (B5/300)	
	607	902101 22200	COUPLING MOTOR SIDE, Ø 42mm (5.5...11kW)	
	607	902102 22200	COUPLING MOTOR SIDE, Ø 48mm (15kW)	
	608	003600 52200	INTERMEDIATE FLANGE (B5/300)	
	609	945349 00000	SOCKET HEAD SCREW	

<sup>1)</sup> Set of seals - 54900052200 - Pos.: 133, 138, 217, 218, 317  
<sup>2)</sup> necessary order quantity / maintenance



A INDICE	Pos.	No. Identification	Designation	FR	
XLF 2.200-2.250	■	549000 52200	JEU DE JOINTS <sup>1)</sup>		
	2	053200 52200	BRIDE DE RACCORDEMENT		
	3	014905 52200	BRIDE POUR MOTEUR (DXLF+DVXLF)		
	3	014906 52200	BRIDE POUR MOTEUR (VXLF)		
	4	918302 52200	CARTER (VXLF)		
	4	918303 52200	CARTER (DXLF)		
	4	918304 52200	CARTER (DVXLF)		
	5	920800 52200	CAPOT DE CANALISATION DE L'AIR		
	6	918300 52200	CARTER		
	7	945324 00000	VIS HEXAGONALE INTERNE		
	8	951710 00000	DISQUE DE RESSORT		
	9	945351 00000	VIS HEXAGONALE INTERNE		
	10	011400 52200	DISQUE DE DISTANCE		
	11	741303 00000	AMORTISSEUR EN CAOUTCHOUC		
	12	945270 00000	VIS BOUT D'ARBRE		
	13	945363 00000	VIS HEXAGONALE INTERNE		
	14	951605 00000	ÉCROU À ANNEAU		
	15	960700 52200	CARTER DE VENTILATEUR		
	20	901809 00000	VIS HEXAGONALE INTERNE		
	24	544503 22200	ACCOUPLLEMENT AVEC VENTILATEUR		
25	949409 00000	RONDELLE			
27	902200 20000	DISQUE D'ACCOUPLLEMENT			
28	064900 30200	BAGUE DE CENTRAGE			
29	945238 00000	VIS HEXAGONALE			
32	946930 00000	PRISONNIER			
33	951925 00000	ELEMENT EN CAOUTCHOUC			
34	950353 00000	RONDELLE À PORTÉE CONIQUE			
35	950354 00000	RONDELLE À PORTÉE SPHÉRIQUE			
36	945237 00000	VIS HEXAGONALE			
38	946962 00000	TOURILLON			
52	743303 00000	GRAISSE SPÉCIFIQUE (POMPE À GRAISSE, 50g)			
57	967059 00000	SUPPORT			
101	000100 52200	CORP DE POMPE			
105	020000 51100	PISTON			
108	901325 00005	PALETTE DE CHARBON - KIT <sup>2)</sup>			
110	947812 00000	CLAVETTE			
111	000700 52200	COUVERCLE A DROITE			
112	000800 52200	COUVERCLE A GAUCHE			
113	001101 52200	COUVERCLE DE ROULEMENTE			
114	001000 52200	COUVERCLE DE ROULEMENTE			
115	945321 00000	VIS HEXAGONALE INTERNE			
116	945230 00000	VIS HEXAGONALE			
117	948742 00000	GROUPILLE CYLINDRIQUE			
119	951703 00000	DISQUE DE RESSORT			
121	068900 91000	BAGUE DE TRANSPORT DE GRAISSE			
124	906649 00000	ROULEMENT A BILLES			
125	906617 20000	ROULEMENT A BILLES			
127	511400 22200	JEU DE DISQUES DE TOLERANCE			
132	906577 00000	BAGUE D'ETANCHEITE			
133	911310 00000	JOINT			
138	003100 52200	JOINT			
139	008102 52200	TUYEAU DE GRAISSAGE			
201	040100 52200	BOITE POUR FILTRE (VXLF+DVXLF)			
201	040102 52200	BOITE POUR FILTRE (DXLF)			
203	909512 00000	CARTOUCHE FILTRANTE (1x) <sup>2)</sup>			
207	945350 00000	VIS HEXAGONALE INTERNE			
209	040200 52200	COUVERCLE DU FILTRE			
211	946919 00000	PRISONNIER			
213	946976 00000	PRISONNIER			
215	921501 50000	POIGNEE			

A INDICE	Pos.	No. Identification	Designation	FR	
	217	007900 22200	JOINT		
	218	008900 52200	JOINT		
	219	007801 52200	BOURRELET DE RACCORDEMENT		
	221	945333 00000	VIS HEXAGONALE INTERNE		
	225	949001 00000	GRAISSEUR		
	227	008103 52200	RACCORD À QUEUE CRANTÉE		
	228	742601 52200	CONDUITE DE GRAISSAGE		
	229	952006 00000	MANCHON DE FIXATION		
	230	042600 10100	TUYAUTERIE FLEXIBLE		
	235	535003 99619	SOUPAPE DE RETENUE - EN OPTION		
	238	945336 00000	VIS HEXAGONALE INTERNE		
	243	912888 00000	BOUCHON		
	244	912801 00000	ELEMENT EN CAOUTCHOUC		
	301	040101 52200	BOITE POUR FILTRE (VXLF)		
	301	040103 52200	BOITE POUR FILTRE (DXLF+DVXLF)		
	313	040201 52200	COUVERCLE DU FILTRE		
	317	000300 52200	JOINT		
	501	539801 52200	SILENCIEUX		
	504	945346 00000	VIS HEXAGONALE INTERNE		
	506	534000 99619	SOUPAPE D'ÉCHAPPEMENT		
	508	534002 99619	SOUPAPE DE SÉCURITÉ - PRESSION		
	511	535001 99619	SOUPAPE DE SÉCURITÉ - VIDE		
	515	734900 99522	CAPUCHON - EN OPTION		
	520	909541 00000	SÉPARATEUR DE LA POUSSIÈRE - EN OPTION		
	601	946945 00000	PRISONNIER		
	603	949455 00000	RONDELLE		
	605	947107 00000	ECROU A 6 PANS		
	607	902100 22200	ACCOUPLLEMENT MOTEUR, Ø 38mm (B5/300)		
	607	902101 22200	ACCOUPLLEMENT MOTEUR, Ø 42mm (5.5...11kW)		
	607	902102 22200	ACCOUPLLEMENT MOTEUR, Ø 48mm (15kW)		
	608	003600 52200	BRIDE INTERMÉDIAIRE (B5/300)		
	609	945349 00000	VIS HEXAGONALE INTERNE		

<sup>1)</sup> Jeu de joints - 54900052200 - Pos.: 133, 138, 217, 218, 317  
<sup>2)</sup> quantité nécessaire / entretien

<b>A</b> INDICE	Pos.	No. Identificazione	Designazione
<b>( ) XLF 2.200-2.250</b>	■	549000 52200	<b>SERIE DI GUARNIZIONE <sup>1)</sup></b>
	2	053200 52200	FLANGIA DI RACCORDE
	3	014905 52200	FLANGIA PER MOTORE (DXLF+DVXLF)
	3	014906 52200	FLANGIA PER MOTORE (VXLF)
	4	918302 52200	CARTER (VXLF)
	4	918303 52200	CARTER (DXLF)
	4	918304 52200	CARTER (DVXLF)
	5	920800 52200	CONDOTTA ARIA
	6	918300 52200	CARTER
	7	945324 00000	VITE ESAGONALE INTERNA
	8	951710 00000	DISCO A MOLLA
	9	945351 00000	VITE ESAGONALE INTERNA
	10	011400 52200	DISCO DISTANZA
	11	741303 00000	AMMORTIZZATORE IN GOMMA
	12	945270 00000	VITE DI CHIUSURA ALBERO
	13	945363 00000	VITE ESAGONALE INTERNA
	14	951605 00000	DADO AD OCCHIELLO
	15	960700 52200	CARTER DEL VENTILATORE
	20	901809 00000	VITE ESAGONALE INTERNA
	24	544503 22200	GIUNTO CON VENTILATORE
	25	949409 00000	RONDELLA
	27	902200 20000	DISCO GUINTO
	28	064900 30200	BOCCOLA DI CENTRAGGIO
	29	945238 00000	VITE ESAGONALE
	32	946930 00000	L'ASTA A VITE
	33	951925 00000	ELEMENTO IN GOMMA
	34	950353 00000	BASE CONICA
	35	950354 00000	RONDELLA CONICA
	36	945237 00000	VITE ESAGONALE
	38	946962 00000	VITE PRIGIONIERA
	52	743303 00000	<b>GRASSO SPECIALE (INGRASSATORE A PISTOLA, 50g)</b>
	57	967059 00000	SUPPORTO
	101	000100 52200	CARCASSA
	105	020000 51100	ROTORE
	108	901325 00005	<b>PALETTE - KIT <sup>2)</sup></b>
	110	947812 00000	CHIAVETTA
	111	000700 52200	COPERCHIO DESTRA
	112	000800 52200	COPERCHIO SINISTRA
	113	001101 52200	COPERCHIO CUSCINETTO
	114	001000 52200	COPERCHIO CUSCINETTO
	115	945321 00000	VITE ESAGONALE INTERNA
	116	945230 00000	VITE ESAGONALE
	117	948742 00000	PERNO
	119	951703 00000	DISCO A MOLLA
	121	068900 91000	ANELLO INGRASSAGGIO
	124	906649 00000	CUSCINETTO A SFERA
	125	906617 20000	CUSCINETTO A SFERA
	127	511400 22200	SERIE DI DISCO A DISTANZA
	132	906577 00000	GUARNIZIONE PER L'ALBERO
	133	911310 00000	GUARNIZIONE
	138	003100 52200	GUARNIZIONE
	139	008102 52200	TUBETTO INGRASSATORE
	201	040100 52200	CARCASSA DEL FILTRO (VXLF+DVXLF)
	201	040102 52200	CARCASSA DEL FILTRO (DXLF)
	203	909512 00000	<b>CARTUCCIA FILTRO (1x) <sup>2)</sup></b>
	207	945350 00000	VITE ESAGONALE INTERNA
	209	040200 52200	COPERCHIO FILTRO
	211	946919 00000	L'ASTA A VITE
	213	946976 00000	L'ASTA A VITE
	215	921501 50000	MANETTA

<b>A</b> INDICE	Pos.	No. Identificazione	Designazione
	217	007900 22200	GUARNIZIONE
	218	008900 52200	GUARNIZIONE
	219	007801 52200	FLANGIA DI RACCORDO
	221	945333 00000	VITE ESAGONALE INTERNA
	225	949001 00000	RACCORDO DI LUBRIFICAZIONE
	227	008103 52200	TUBO CONNETTORE
	228	742601 52200	TUBAZIONE DI LUBRIFICAZIONE
	229	952006 00000	MANICOTTO DI FISSAZIONE
	230	042600 10100	TUBAZIONE FLESSIBILE
	235	535003 99619	VALVOLA DI RITENUTA - OPTIONALE
	238	945336 00000	VITE ESAGONALE INTERNA
	243	912888 00000	TAPPO
	244	912801 00000	ELEMENTO IN GOMMA
	301	040101 52200	CARCASSA DEL FILTRO (VXLF)
	301	040103 52200	CARCASSA DEL FILTRO (DXLF+DVXLF)
	313	040201 52200	COPERCHIO FILTRO
	317	000300 52200	GUARNIZIONE
	501	539801 52200	SILENZIATORE
	504	945346 00000	VITE ESAGONALE INTERNA
	506	534000 99619	VALVOLA DI SFIATO
	508	534002 99619	VALVOLA DI SICUREZZA - PRESSIONE
	511	535001 99619	VALVOLA DI SICUREZZA - VUOTO
	515	734900 99522	GUAINA - OPTIONALE
	520	909541 00000	<b>SEPARATORE DELLE POLVERI - OPTIONALE</b>
	601	946945 00000	L'ASTA A VITE
	603	949455 00000	RONDELLA
	605	947107 00000	DADO ESAGONALE
	607	902100 22200	GIUNTO MOTORE, Ø 38mm (B5/300)
	607	902101 22200	GIUNTO MOTORE, Ø 42mm (5.5...11kW)
	607	902102 22200	GIUNTO MOTORE, Ø 48mm (15kW)
	608	003600 52200	FLANGIA INTERMEDIA (B5/300)
	609	945349 00000	VITE ESAGONALE INTERNA

<sup>1)</sup> Serie di guarnizione - 54900052200 - Pos.: 133, 138, 217, 218, 317  
<sup>2)</sup> quantità di ordinazione necessari / manutenzione

A INDICE	Pos.	No. De pedido	Descripción	
( ) XLF 2.200-2.250	■	549000 52200	JUEGO DE JUNTAS <sup>1)</sup>	
	2	053200 52200	FAROL	
	3	014905 52200	BRIDA DE MOTOR (DXLF+DVXLF)	
	3	014906 52200	BRIDA DE MOTOR (VXLF)	
	4	918302 52200	CAPERUZA DE RECUBRIMIENTO (VXLF)	
	4	918303 52200	CAPERUZA DE RECUBRIMIENTO (DXLF)	
	4	918304 52200	CAPERUZA DE RECUBRIMIENTO (DVXLF)	
	5	920800 52200	ANILLO CONDUCTOR DE AIRE	
	6	918300 52200	CAPERUZA DE RECUBRIMIENTO	
	7	945324 00000	TORNILLO HEXAGONAL INTERIOR	
	8	951710 00000	ARANDELA ELÁSTICA	
	9	945351 00000	TORNILLO HEXAGONAL INTERIOR	
	10	011400 52200	PIEZA DISTANCIADORA	
	11	741303 00000	AMORTIGUADOR DE GOMA	
	12	945270 00000	TORNILLO TERMINAL DE ÁRBOL	
	13	945363 00000	TORNILLO HEXAGONAL INTERIOR	
	14	951605 00000	TUERCA M16	
	15	960700 52200	CAPERUZA DE VENTILADOR	
	20	901809 00000	TORNILLO HEXAGONAL INTERIOR	
	24	544503 22200	MITAD DE ACOPLAMIENTO CON VENTILADOR	
	25	949409 00000	ARANDELA	
	27	902200 20000	DISCO DE ACOPLAMIENTO	
	28	064900 30200	MANGUITO DE CENTRADO	
	29	945238 00000	TORNILLO DE CABEZA HEXAGONAL	
	32	946930 00000	ESPÁRRAGO	
	33	951925 00000	PIEZA DE ORMA DE GOMA	
	34	950353 00000	ANILLO CÓNICO FUERTE	
	35	950354 00000	ARANDELA ESFÉRICA	
	36	945237 00000	TORNILLO DE CABEZA HEXAGONAL	
	38	946962 00000	ESPÁRRAGO	
	52	743303 00000	GRASA ESPECIAL (PISTOLA DE GRASA, 50g)	
	57	967059 00000	SOPORTE	
	101	000100 52200	CARCASA	
	105	020000 51100	ÉMBOLO	
	108	901325 00005	DESPLAZADOR DE CARBÓN - KIT <sup>2)</sup>	
	110	947812 00000	LENGÜETA DE AJUSTE	
	111	000700 52200	TAPA LATERAL DERECHA	
	112	000800 52200	TAPA LATERAL IZQUIERDA	
	113	001101 52200	TAPA DE COJINETE	
	114	001000 52200	TAPA DE COJINETE	
	115	945321 00000	TORNILLO HEXAGONAL INTERIOR	
	116	945230 00000	TORNILLO DE CABEZA HEXAGONAL	
	117	948742 00000	PASADOR ENTALLADO DE AJUSTE	
	119	951703 00000	ARANDELA ELÁSTICA	
	121	068900 91000	ANILLO DE TRANSPORTE DE GRASA	
	124	906649 00000	COJINETE DE RODAMIENTO	
	125	906617 20000	COJINETE DE RODAMIENTO	
	127	511400 22200	JUEGO DE ARANDELAS DE AJUSTE	
	132	906577 00000	ANILLO DE JUNTA DE ÁRBOL	
	133	911310 00000	MANGUERA DE JUNTA	
	138	003100 52200	JUNTA	
	139	008102 52200	TUBITO DE GRASA	
	201	040100 52200	CARCASA DE FILTRO (VXLF+DVXLF)	
	201	040102 52200	CARCASA DE FILTRO (DXLF)	
	203	909512 00000	CARTUCHO DE FILTRO (1x) <sup>2)</sup>	
	207	945350 00000	TORNILLO HEXAGONAL INTERIOR	
	209	040200 52200	TAPA DE FILTRO	
	211	946919 00000	ESPÁRRAGO	
	213	946976 00000	ESPÁRRAGO	
	215	921501 50000	EMPUÑADURA	

A INDICE	Pos.	No. De pedido	Descripción	
	217	007900 22200	JUNTA	
	218	008900 52200	JUNTA	
	219	007801 52200	BRIDA DE EMPALME	
	221	945333 00000	TORNILLO HEXAGONAL INTERIOR	
	225	949001 00000	BOQUILLA DE LUBRICACIÓN	
	227	008103 52200	EMPALME DE EXTREMIDAD	
	228	742601 52200	CONDUCTO DE ENGRASE	
	229	952006 00000	MANGUITO DE FIJACIÓN	
	230	042600 10100	MANGUERA	
	235	535003 99619	VÁLVULA DE RETENCIÓN - OPCIONAL	
	238	945336 00000	TORNILLO HEXAGONAL INTERIOR	
	243	912888 00000	TAPÓN	
	244	912801 00000	PIEZA DE ORMA DE GOMA	
	301	040101 52200	CARCASA DE FILTRO (VXLF)	
	301	040103 52200	CARCASA DE FILTRO (DXLF+DVXLF)	
	313	040201 52200	TAPA DE FILTRO	
	317	000300 52200	JUNTA	
	501	539801 52200	SILENCIADOR	
	504	945346 00000	TORNILLO HEXAGONAL INTERIOR	
	506	534000 99619	VÁLVULA DE ESCAPE	
	508	534002 99619	VÁLVULA DE SEGURIDAD - PRESIÓN	
	511	535001 99619	VÁLVULA DE SEGURIDAD - VACÍO	
	515	734900 99522	TAPA - OPCIONAL	
	520	909541 00000	SEPARADOR DE POLVO - OPCIONAL	
	601	946945 00000	ESPÁRRAGO	
	603	949455 00000	ARANDELA	
	605	947107 00000	TUERCA HEXAGONAL	
	607	902100 22200	ACOPAMIENTO DE MOTOR, Ø 38mm (B5/300)	
	607	902101 22200	ACOPAMIENTO DE MOTOR, Ø 42mm (5.5...11kW)	
	607	902102 22200	ACOPAMIENTO DE MOTOR, Ø 48mm (15kW)	
	608	003600 52200	BRIDA INTERMEDIO (B5/300)	
	609	945349 00000	TORNILLO HEXAGONAL INTERIOR	

<sup>1)</sup> Junta completa - 54900052200 - Pos.: 133, 138, 217, 218, 317  
<sup>2)</sup> cantidad necesario / mantenimiento

( )XLF 2.200 ( )XLF 2.250	Variante 	Pos. <sup>2)</sup>	Bestell Nr. / Ident No. / No. Identification / No. Identificazione / No. De pedido		Beschreibung / Description / Designation / Designazione / Desripcion
① DXLF 2.250 K DVXLF 2.250 K - mit Kühler - with cooler - avec refroidisseur - con raffreddamento - con refrigerador		502	945345 00000		INNENSECHSKANTSCHRAUBE / SOCKET HEAD SCREW / VIS HEXAGONALE INTERNE / VITE ESAGONALE INTERNA / TORNILLO HEXAGONAL INTERIOR
		507	060301 52200		ANSCHLUSSSTÜCK / MANIFOLD / BOÎTE DE DÉRIVATION / SCATOLA DI CONNESSIONE / CAJA DE CONEXIÓN
		509	008903 22200		DICHTUNG / GASKET / JOINT / GUARNIZIONE / JUNTA
		510	945330 04000		INNENSECHSKANTSCHRAUBE / SOCKET HEAD SCREW / VIS HEXAGONALE INTERNE / VITE ESAGONALE INTERNA / TORNILLO HEXAGONAL INTERIOR
		512	007900 22200		DICHTUNG / GASKET / JOINT / GUARNIZIONE / JUNTA
		513	560201 22200		KÜHLER / COOLER / REFRIGÉRISEUR / RAFFREDDATORE / REFRIGERADOR
② VXLF 2.250 SK - mit Spülkühler - with special cooler - avec refroidisseur spécial - con radiatore speciale - con refrigerador especial		10	011401 52200	<del>011400-52200</del>	DISTANZSCHEIBE / DISTANCE-DISK / DISQUE AJUSTAGE / DISCO DISTANZA / ARANDELA DISTANCIADORA
		32	946969 00000	<del>946930-00000</del>	STIFTSCHRAUBE / STUD / PRISONNIER / L'ASTA A VITE / ESPÁRRAGO
		36	945129 00000	<del>945237-00000</del>	SECHSKANTSCHRAUBE / HEX-HEAD SCREW / VIS HEXAGONALE / VITE ESAGONALE / TORNILLO DE CABEZA HEXAGONAL
		53	011400 22200		DISTANZSCHEIBE / DISTANCE-DISK / DISQUE AJUSTAGE / DISCO DISTANZA / ARANDELA DISTANCIADORA
		54	011402 52200		DISTANZSCHEIBE / DISTANCE-DISK / DISQUE AJUSTAGE / DISCO DISTANZA / ARANDELA DISTANCIADORA
		55	913110 01000		DICHTUNG / GASKET / JOINT / GUARNIZIONE / JUNTA
		401	004600 52200		FILTERGEHÄUSE / FILTER HOUSING / BOITE POUR FILTRE / CONTENITORE FILTRO / CARCASA DE FILTRO
		403	008901 52200		DICHTUNG / GASKET / JOINT / GUARNIZIONE / JUNTA
		404	008902 52200		DICHTUNG / GASKET / JOINT / GUARNIZIONE / JUNTA
		405	945376 00000		INNENSECHSKANTSCHRAUBE / SOCKET HEAD SCREW / VIS HEXAGONALE INTERNE / VITE ESAGONALE INTERNA / TORNILLO HEXAGONAL INTERIOR
		407	946973 00000		STIFTSCHRAUBE / STUD / PRISONNIER / L'ASTA A VITE / ESPÁRRAGO
		408	946975 00000		STIFTSCHRAUBE / STUD / PRISONNIER / L'ASTA A VITE / ESPÁRRAGO
		409	040203 52200		DECKEL / COVER / COUVERCLE / COPERCHIO / TAPA
		412	909510 00000		<b>FILTERPATRONE / FILTER CARTRIDGE / CARTOUCHE FILTRANTE / CARTUCCIA FILTRO / CARTUCHO DE FILTRO</b>
		413	921501 50000		HANDGRIFF / HANDLE / POIGNEE / MANETTA / EMPUÑADURA

<sup>2)</sup> variantenabhängige Bauteile / variant-dependent components / composants variante-dependantes / componenti variante-dispendenti / componentes variante-dependientes



( )XLF 2.200 ( )XLF 2.250	Variante 	Pos. <sup>2)</sup>	Bestell Nr. / Ident No. / No. Identification / No. Identificazione / No. De pedido		Beschreibung / Description / Designation / Designazione / Desripcion	
③ DVXLF 2.250 <b>KSK</b> - mit Kühler und Spülkühler - with special cooler - avec refroidisseur spécial - con radiatore speciale - con refrigerador especial		10	011401 52200	<del>011400 52200</del>	DISTANZSCHEIBE / DISTANCE-DISK / DISQUE AJUSTAGE / DISCO DISTANZA / ARANDELA DISTANCIADORA	
		32	946969 00000	<del>946930 00000</del>	STIFTSCHRAUBE / STUD / PRISONNIER / L'ASTA A VITE / ESPÁRRAGO	
		36	945129 00000	<del>945237 00000</del>	SECHSKANTSCHRAUBE / HEX-HEAD SCREW / VIS HEXAGONALE / VITE ESAGONALE / TORNILLO DE CABEZA HEXAGONAL	
		53	011400 22200		DISTANZSCHEIBE / DISTANCE-DISK / DISQUE AJUSTAGE / DISCO DISTANZA / ARANDELA DISTANCIADORA	
		54	011402 52200		DISTANZSCHEIBE / DISTANCE-DISK / DISQUE AJUSTAGE / DISCO DISTANZA / ARANDELA DISTANCIADORA	
		55	913110 01000		DICHTUNG / GASKET / JOINT / GUARNIZIONE / JUNTA	
		401	004600 52200		FILTERGEHÄUSE / FILTER HOUSING / BOITE POUR FILTRE / CONTENITORE FILTRO / CARCASA DE FILTRO	
		403	008901 52200		DICHTUNG / GASKET / JOINT / GUARNIZIONE / JUNTA	
		404	008902 52200		DICHTUNG / GASKET / JOINT / GUARNIZIONE / JUNTA	
		405	945376 00000		INNENSECHSKANTSCHRAUBE / SOCKET HEAD SCREW / VIS HEXAGONALE INTERNE / VITE ESAGONALE INTERNA / TORNILLO HEXAGONAL INTERIOR	
		407	946973 00000		STIFTSCHRAUBE / STUD / PRISONNIER / L'ASTA A VITE / ESPÁRRAGO	
		408	946975 00000		STIFTSCHRAUBE / STUD / PRISONNIER / L'ASTA A VITE / ESPÁRRAGO	
		409	040203 52200		DECKEL / COVER / COUVERCLE / COPERCHIO / TAPA	
		412	909510 00000		<b>FILTERPATRONE / FILTER CARTRIDGE / CARTOUCHE FILTRANTE / CARTUCCIA FILTRO / CARTUCHO DE FILTRO</b>	
		413	921501 50000		HANDGRIFF / HANDLE / POIGNEE / MANETTA / EMPUÑADURA	
	④ VXLf 2.250/0- <b>4XX</b> - mit Frequenzumrichter - with frequency convertor - avec convertisseur de fréquence - con convertitore di frequenza - con convertidor de frecuencia		701	796302 51115		<b>7,5KW</b> - FREQUENZUMFORMER / FREQUENCY CONVERTOR / CONVERTISSEUR DE FRÉQUENCE / CONVERTITORE DI FREQUENZA / CONVERTIDOR DE FRECUENCIA
			702	003602 52115		ADAPTERPLATTE / ADAPTER PLATE / PLATINE D'ADAPTION / ADATTATORE PIATTO / PLACA ADAPTADORA
		703	025500 24000		DICHTUNG / GASKET / JOINT / GUARNIZIONE / JUNTA	
		704	945320 00000		INNENSECHSKANTSCHRAUBE / SOCKET HEAD SCREW / VIS HEXAGONALE INTERNE / VITE ESAGONALE INTERNA / TORNILLO HEXAGONAL INTERIOR	
⑤ DXLF 2.250/0- <b>4XX</b> - mit Frequenzumrichter - with frequency convertor - avec convertisseur de fréquence - con convertitore di frequenza - con convertidor de frecuencia			701	769312 41101		<b>15KW</b> - FREQUENZUMFORMER / FREQUENCY CONVERTOR / CONVERTISSEUR DE FRÉQUENCE / CONVERTITORE DI FREQUENZA / CONVERTIDOR DE FRECUENCIA
			702	003602 83111		ADAPTERPLATTE / ADAPTER PLATE / PLATINE D'ADAPTION / ADATTATORE PIATTO / PLACA ADAPTADORA
			704	945377 00000		INNENSECHSKANTSCHRAUBE / SOCKET HEAD SCREW / VIS HEXAGONALE INTERNE / VITE ESAGONALE INTERNA / TORNILLO HEXAGONAL INTERIOR

<sup>2)</sup> variantenabhängige Bauteile / variant-dependent components / composants variante-dependantes / componenti variante-dispendenti / componentes variante-dependientes