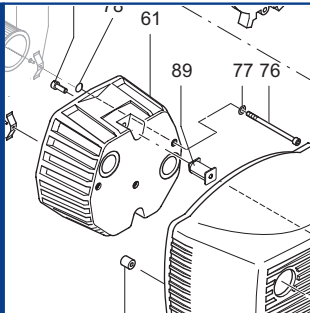

VT 4.40

SERVICE

BECKER
D-42279 Wuppertal
www.becker-international.com

No. **C** year XXXX

type **VT 4.40-XX** Index Variante

frequency XXXX Hz

speed XXXX min⁻¹

power required XXXX kW

inlet capacity XXXX m³/h

pressure + XXXX mbar

vacuum - XXXX mbar

Made in Germany



Ersatzteilliste
Spare parts list
Liste de pièces de rechange
Listino pezzi di ricambio
Lista de piezas de recambio
Lista de peças sobresselentes
Reserveonderdelenlijst
Atsarginių dalių sąrašas
Varuosad nimekirja
Rezerves daļu saraksts

Reservedelsliste
Reservdelslista
Varaosuettelo
Reservedelsliste
Wykaz części zamiennych
Tartalékalkatrész lista
Seznam náhradních dílů
Seznam nadomestnih delov
Zoznam náhradných dielov
Rezervni dijelovi popis

Lista pieselor de schimb
Páirteanna spártha liosta
Κατάλογος ανταλλακτικών
Yedek parça listesi
Списък на резервните части
Перечень запасных частей
スペアパーツリスト
예비 부품 목록
备用零件目录

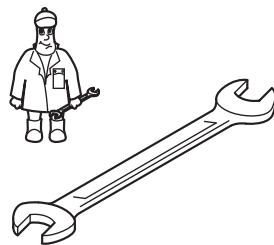

Pos.	Menge ²⁾ Quantity Quantité Quantità Cantidad	Bestell-Nr. Ident No. No. Identification No. Identificazione No. de pedido	Bezeichnung Description Designation Designazione Descripción
24	SATZ/KIT	901352 00007	Schieber, Rotor Vane, Palette, Empujador
72	1	909505 00000	Filterpatrone, Filter cartridge, Cartouche Filtrante, Cartuccia filtro, Cartucho de filtro
74	1	909529 00000	- VT 4.40/0-65 Filterpatrone, Filter cartridge, Cartouche Filtrante, Cartuccia filtro, Cartucho de filtro

²⁾ erforderliche Bestellmenge / necessary order quantity / quantité nécessaire / quantità di ordinazione necessari / cantidad necesario

Wartung
Maintenance
Entretien
Manutenzione
Mantenimiento



Sales and service network

VT 4.40

Standard



Variante



VT 4.40/XX

①

- 1~ Einphasenwechselstrom
- 1~ single-phase AC
- 1~ AC monophasé
- 1~ AC monofase
- 1~ AC monofásica

② /0-65

- Abluftanschluß oben
- exhaust connection above
- raccord d'évacuation d'air en haut
- allacciamento emissioni gassose disopra
- conexión de aire de escape superior

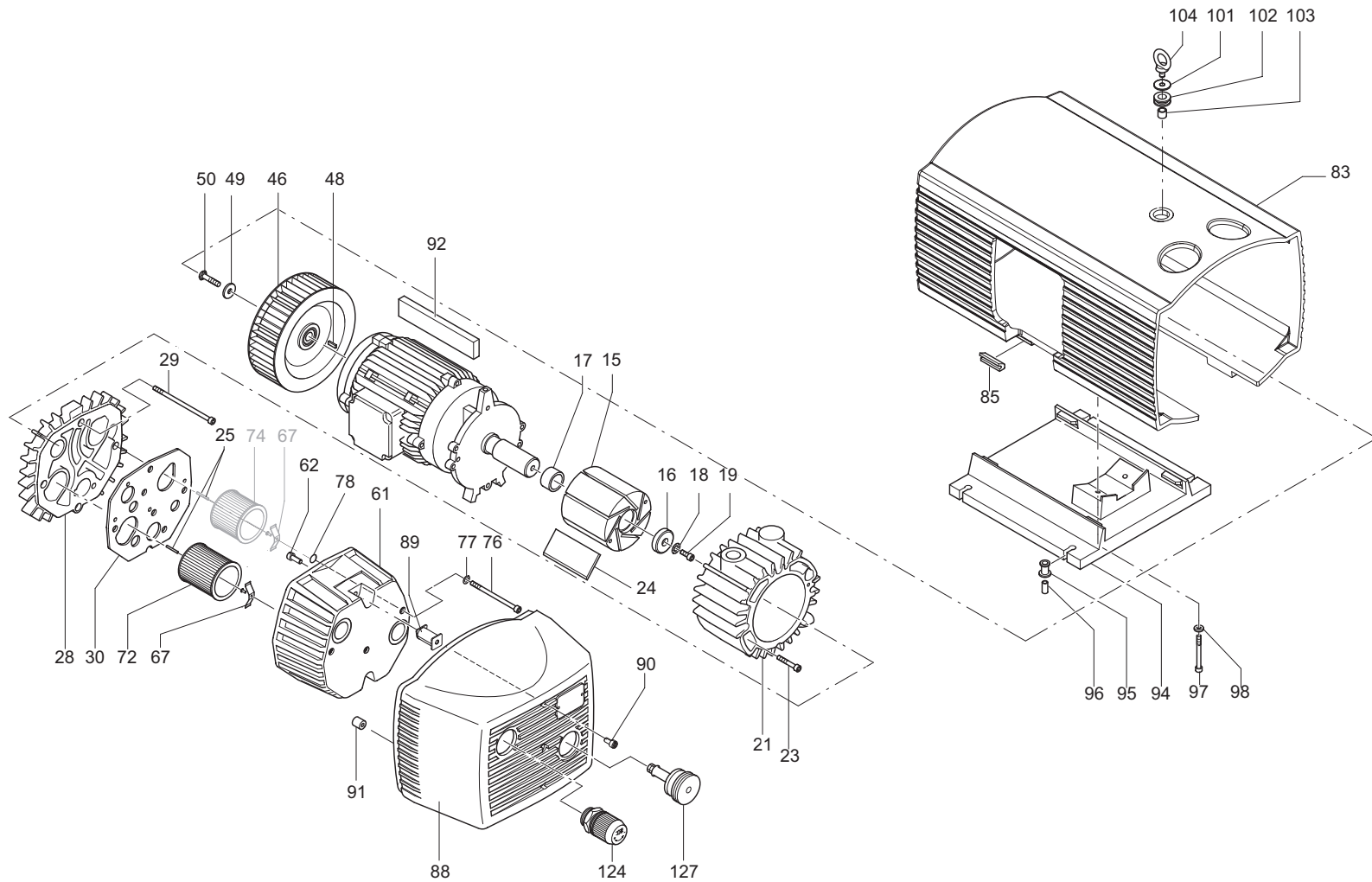

SERVICE

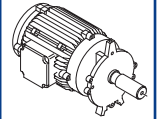

 C = ? μ F
U = ? V

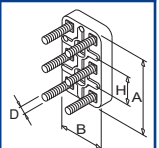
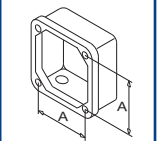
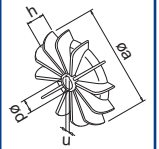
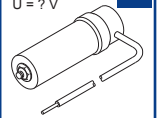
1~



C INDEX	Pos.	Bestell Nr.	Beschreibung	
VT 4.40	15	020000 16500	KOLBEN	
	16	016800 16500	SPANNSCHEIBE	
	17	911008 00000	STAR-TOLERANZRING	
	18	949203 00000	ZAHNSCHEIBE	
	19	945320 00000	INNENSECHSKANTSCHRAUBE	
	21	000102 16500	GEHÄUSE	
	23	945322 00000	INNENSECHSKANTSCHRAUBE	
	24	901352 00007	SCHIEBER, KOHLE (SATZ)	
	25	952009 00000	SPANNHÜLSE	
	28	000710 16500	SEITENDECKEL	
	29	945374 00000	INNENSECHSKANTSCHRAUBE	
	30	008900 16500	DICHTUNG	
	46	902300 26200	VENTILATOR MIT NABE	
	48	947713 00000	PASSFEDER	
	49	949454 00000	U-SCHEIBE	
	50	901804 00000	WELLENENDSCHRAUBE TUFLOK	
	61	004804 27600	FILTERDECKEL	
	62	945319 00000	INNENSECHSKANTSCHRAUBE	
	67	009000 16300	ANPRESSFEDER	
	72	909505 00000	FILTERPATRONE (1x)¹⁾	
	76	945373 00000	INNENSECHSKANTSCHRAUBE	
	77	948021 00000	DICHTRING	
	78	913161 00000	O-RING	
	83	006801 27600	GERÄTEHAUBE	
	85	951920 00000	GUMMIFORMTEIL	
	88	006802 27600	GERÄTEHAUBE	
	89	741300 27601	DÄMMAUFLAGE	
90	945318 00000	INNENSECHSKANTSCHRAUBE		
91	951922 00000	GUMMIFORMTEIL		
92	964109 00000	KANTENSCHUTZ		
94	015100 27600	FUSS		
95	951921 00000	GUMMIFORMTEIL		
96	068000 27600	DISTANZSTÜCK		
97	945328 00000	INNENSECHSKANTSCHRAUBE		
98	949451 00000	UNTERLEGSCHNEIBE		
101	833903 99597	VENTILTELLER		
102	951906 00000	KABELTÜLLE		
103	068002 16500	DISTANZROHR		
104	548800 16300	RINGSCHRAUBE		
124	736001 99613	VAKUUMREGULIERVENTIL		
127	727502 06000	ABBLASEVENTIL		

¹⁾erforderliche Bestellmenge / Wartung

C INDEX	Pos.	Ident No.	Description	
VT 4.40	15	020000 16500	ROTOR	
	16	016800 16500	CLAMPING DISC	
	17	911008 00000	STAR-TOLERANCE-RING	
	18	949203 00000	TOOTHED SPRING WASHER	
	19	945320 00000	SOCKET HEAD SCREW	
	21	000102 16500	PUMP BODY	
	23	945322 00000	SOCKET HEAD SCREW	
	24	901352 00007	CARBON VANES (KIT)	
	25	952009 00000	LOCATING PIN	
	28	000710 16500	LID	
	29	945374 00000	SOCKET HEAD SCREW	
	30	008900 16500	GASKET	
	46	902300 26200	FAN	
	48	947713 00000	KEY	
	49	949454 00000	WASHER	
	50	901804 00000	SHAFT END BOLT	
	61	004804 27600	FILTER COVER	
	62	945319 00000	SOCKET HEAD SCREW	
	67	009000 16300	BLADE SPRING	
	72	909505 00000	FILTER CARTRIDGE (1x)¹⁾	
	76	945373 00000	SOCKET HEAD SCREW	
	77	948021 00000	SEALING RING	
	78	913161 00000	O-RING	
	83	006801 27600	PROTECTING HOOD	
	85	951920 00000	RUBBER ELEMENT	
	88	006802 27600	PROTECTING HOOD (FRONT)	
	89	741300 27601	VIBRATION DAMPER	
90	945318 00000	SOCKET HEAD SCREW		
91	951922 00000	RUBBER ELEMENT		
92	964109 00000	EDGE PROTECTION		
94	015100 27600	FOOT		
95	951921 00000	RUBBER ELEMENT		
96	068000 27600	SPACING COLLAR		
97	945328 00000	SOCKET HEAD SCREW		
98	949451 00000	WASHER		
101	833903 99597	DISC		
102	951906 00000	RUBBER BUSHING		
103	068002 16500	SPACER TUBE		
104	548800 16300	EYE SCREW		
124	736001 99613	VACUUM REGULATING VALVE		
127	727502 06000	BLOW-OFF VALVE		

¹⁾ necessary order quantity / maintenance

C INDICE	Pos.	No. Identification	Designation		
VT 4.40	15	020000 16500	PISTON		
	16	016800 16500	DISQUE DE SERRAGE		
	17	911008 00000	BAGUE STAR		
	18	949203 00000	DENT DISQUE		
	19	945320 00000	VIS HEXAGONALE INTERNE		
	21	000102 16500	CORP DE POMPE		
	23	945322 00000	VIS HEXAGONALE INTERNE		
	24	901352 00007	PALETTE DE CHARBON (KIT)		
	25	952009 00000	DOVILLE DE ETRAGE		
	28	000710 16500	COUVERCLE		
	29	945374 00000	VIS HEXAGONALE INTERNE		
	30	008900 16500	JOINT		
	46	902300 26200	VENTILATEUR		
	48	947713 00000	CLAVETTE		
	49	949454 00000	RONDELLE		
	50	901804 00000	VIS BOUT D'ARBRE		
	61	004804 27600	COUVERCLE DU FILTRE		
	62	945319 00000	VIS HEXAGONALE INTERNE		
	67	009000 16300	RESSORT-JAME		
	72	909505 00000	CARTOUCHE FILTRANTE (1x)¹⁾		
	76	945373 00000	VIS HEXAGONALE INTERNE		
	77	948021 00000	JOINT		
	78	913161 00000	ANNEAU-O		
	83	006801 27600	CARTER PROTECTEUR		
	85	951920 00000	ELEMENT EN CAOUTCHOUC		
	88	006802 27600	CARTER PROTECTEUR		
	89	741300 27601	AMORTISSEUR DE VIBRATIONS		
90	945318 00000	VIS HEXAGONALE INTERNE			
91	951922 00000	ELEMENT EN CAOUTCHOUC			
92	964109 00000	PROTECTION D'ARETE			
94	015100 27600	PIED			
95	951921 00000	ELEMENT EN CAOUTCHOUC			
96	068000 27600	DONILLE D'ECARMENT			
97	945328 00000	VIS HEXAGONALE INTERNE			
98	949451 00000	RONDELLE			
101	833903 99597	PLATEAU DE SOUPAPE			
102	951906 00000	PROTECTION EN CAOUTCHOUC			
103	068002 16500	TUBE D'ECARTEMENT			
104	548800 16300	PITON			
124	736001 99613	SOUPAPE REGLAGE VIDE			
127	727502 06000	SILENCIEUX			



¹⁾ quantité nécessaire / entretien

C INDICE	Pos.	No. Identificazione	Designazione		
VT 4.40	15	020000 16500	ROTORE		
	16	016800 16500	DISCO DI FISSAGGIO		
	17	911008 00000	STAR-ANELLO TOLLERANZA		
	18	949203 00000	DISCO A DENTE		
	19	945320 00000	VITE ESAGONALE INTERNA		
	21	000102 16500	CARCASSA		
	23	945322 00000	VITE ESAGONALE INTERNA		
	24	901352 00007	PALETTE DI CHARBONE (KIT)		
	25	952009 00000	SPINE DI RISCONTRO		
	28	000710 16500	COPERCHIO		
	29	945374 00000	VITE ESAGONALE INTERNA		
	30	008900 16500	GUARNIZIONE		
	46	902300 26200	VENTILATORE		
	48	947713 00000	CHIAVETTA		
	49	949454 00000	RONDELLA		
	50	901804 00000	VITE DI CHIUSURA ALBERO		
	61	004804 27600	COPERCHIO FILTRO		
	62	945319 00000	VITE ESAGONALE INTERNA		
	67	009000 16300	MOLLA		
	72	909505 00000	CARTUCCIA FILTRO (1x)¹⁾		
	76	945373 00000	VITE ESAGONALE INTERNA		
	77	948021 00000	ANELLO GUARNIZIONE		
	78	913161 00000	ANELLO-O		
	83	006801 27600	CAPOTO DI PRTEZIONE		
	85	951920 00000	ELEMENTO IN GOMMA		
	88	006802 27600	CARTER DI PROTEZIONE		
	89	741300 27601	AMMORTIZZATORE DI VIBRAZIONI		
90	945318 00000	VITE ESAGONALE INTERNA			
91	951922 00000	ELEMENTO IN GOMMA			
92	964109 00000	LISTELLO DI PROTEZIONE			
94	015100 27600	PIEDE			
95	951921 00000	ELEMENTO IN GOMMA			
96	068000 27600	BOCCOLA DISTANZIATRICE			
97	945328 00000	VITE ESAGONALE INTERNA			
98	949451 00000	RONDELLA			
101	833903 99597	PIATELLO DELLA VALVOLA			
102	951906 00000	PROTEZIONE IN GOMMA			
103	068002 16500	TUBO DISTANZA			
104	548800 16300	GANCIO			
124	736001 99613	VALVOLA REGOLAZIONE VUOTO			
127	727502 06000	SILENZIATORE			

¹⁾ quantità di ordinazione necessari / manutenzione

C INDICE	Pos.	No. De pedido	Descripción		
VT 4.40	15	020000 16500	ÉMBOLO		
	16	016800 16500	ARANDELA TENSORA		
	17	911008 00000	ANILLO DE TOLERANCIA STAR		
	18	949203 00000	POLEA DENTADA		
	19	945320 00000	TORNILLO HEXAGONAL INTERIOR		
	21	000102 16500	CARCASA		
	23	945322 00000	TORNILLO HEXAGONAL INTERIOR		
	24	901352 00007	EMPUJADOR DE CARBÓN (KIT)		
	25	952009 00000	CASQUILLO TENSOR		
	28	000710 16500	TAPA LATERAL		
	29	945374 00000	TORNILLO HEXAGONAL INTERIOR		
	30	008900 16500	JUNTA		
	46	902300 26200	VENTILADOR CON CUBO		
	48	947713 00000	LENGÜETA DE AJUSTE		
	49	949454 00000	ARANDELA		
	50	901804 00000	TORNILLO TERMINAL DE ÁRBOL TUFLOK		
	61	004804 27600	TAPA DE FILTRO		
	62	945319 00000	TORNILLO HEXAGONAL INTERIOR		
	67	009000 16300	MUELLE DE PRESIÓN		
	72	909505 00000	CARTUCHO DE FILTRO (1x)¹⁾		
	76	945373 00000	TORNILLO HEXAGONAL INTERIOR		
	77	948021 00000	ANILLO DE JUNTA		
	78	913161 00000	JUNTA TÓRICA		
	83	006801 27600	CAPERUZA DE APARATO		
	85	951920 00000	PIEZA DE ORMA DE GOMA		
	88	006802 27600	CAPERUZA DE APARATO		
	89	741300 27601	AMORTIGUADOR DE VIBRACIONES		
	90	945318 00000	TORNILLO HEXAGONAL INTERIOR		
	91	951922 00000	PIEZA DE ORMA DE GOMA		
	92	964109 00000	PROTECCIÓN DE CANTOS		
	94	015100 27600	PIE		
	95	951921 00000	PIEZA DE ORMA DE GOMA		
	96	068000 27600	PIEZA DISTANCIADORA		
	97	945328 00000	TORNILLO HEXAGONAL INTERIOR		
	98	949451 00000	ARANDELA		
	101	833903 99597	PLATILLO DE VÁLVULA		
	102	951906 00000	BOQUILLA DE CABLE		
	103	068002 16500	TUBO DISTANCIADOR		
	104	548800 16300	TORNILLO DE CÁNCAMO		
	124	736001 99613	VÁLVULA REGULADORA DE VACÍO		
	127	727502 06000	VÁLVULA DE BARRIDO		

¹⁾ cantidad necesario / mantenimiento

VT 4.40	Variante 	Pos. ²⁾	Bestell Nr. / Ident No. / No. Identification / No. Identificazione / No. De pedido		Beschreibung / Description / Designation / Designazione / Desripcion
					
① 1~ Einphasenwechselstrom 1~ single-phase AC 1~ AC monophasé 1~ AC monofase 1~ AC monofásica		13	742002 30000		KABEL / CABLE / CABLE / CAVO / CABLE
		83	006805 27600	006804 27600	HAUBE / PROTECTING HOOD / CARTER PROTECTEUR / CARTER DI PROTEZIONE / CAPERUZA
		94	015101 27600	015100 27600	FUSS / FOOT / PIED / PIEDE / PIE
② /0-65 - Abluftanschluß oben - exhaust connection above - raccord d'évacuation d'air en haut - allacciamento emissioni gassose disopra - conexión de aire de escape superior		21	000100 16500	000102 16500	GEHÄUSE / PUMP BODY / CORP DE POMPE / CARCASSA / CARCASA
		28	000700 16500	000740 16500	SEITENDECKEL / LID / COUVERCLE / COPERCHIO / TAPA LATERAL
		74	909529 00000		FILTERPATRONE / FILTER CARTRIDGE / CARTOUCHE FILTRANTE / CARTUCCIA FILTRO / CARTUCHO DE FILTRO
		83	006806 27600	006804 27600	HAUBE / PROTECTING HOOD / CARTER PROTECTEUR / CARTER DI PROTEZIONE / CAPERUZA

²⁾ variantenabhängige Bauteile / variant-dependent components / composants variante-dependantes / componenti variante-dispendenti / componentes variante-dependientes