

# X

## VX 4.25 VX 4.40

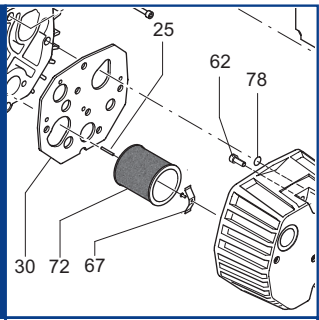

**SERVICE**

**BECKER**  
D-42279 Wuppertal  
www.becker-international.com

No. **C** year

type **VX 4.25-XX** Made in  Germany

frequency  Hz

speed  min<sup>-1</sup>

power required  kW

inlet capacity  m<sup>3</sup>/h

pressure +  mbar

vacuum -  mbar

**Index Variante**

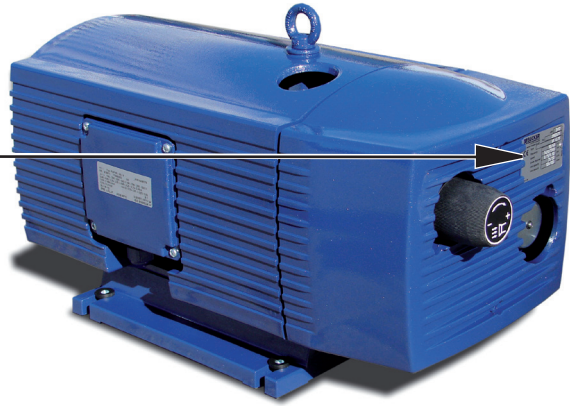

**Ersatzteilliste**  
Spare parts list  
Liste de pièces de rechange  
Listino pezzi di ricambio  
Lista de piezas de recambio  
Lista de peças sobresselentes  
Reserveonderdelenlijst  
Atsarginių dalių sąrašas  
Varuosad nimekirja  
Rezerves daļu saraksts

**Reservedelsliste**  
Reservdelslista  
Varaosuettelolo  
Reservedelsliste  
Wykaz części zamiennych  
Tartalékalkatrész lista  
Seznam náhradních dílů  
Seznam nadomestnih delov  
Zoznam náhradných dielov  
Rezervni dijelovi popis

**Lista pieselor de schimb**  
Páirteanna spártha liosta  
Κατάλογος ανταλλακτικών  
Yedek parça listesi  
Списък на резервните части  
Перечень запасных частей  
スペアパーツリスト  
예비 부품 목록  
备用零件目录

# SERVICE

[www.becker-international.com](http://www.becker-international.com)

Sales and service network

**Wartung**  
**Maintenance**  
**Entretien**  
**Manutenzione**  
**Mantenimiento**

Pos.	Menge <sup>2)</sup> Quantity Quantité Quantità Cantidad	Bestell-Nr. Ident No. No. Identification No. Identificazione No. de pedido	Bezeichnung Description Designation Designazione Descripción
<b>VX 4.25</b>			
24	SATZ/KIT	901399 00007	Schieber, Rotor Vane, Palette, Empujador
72	1	909505 01000	Filterpatrone, Filter cartridge, Cartouche Filtrante, Cartuccia filtro, Cartucho de filtro
<b>VX 4.40</b>			
24	SATZ/KIT	901397 00007	Schieber, Rotor Vane, Palette, Empujador
72	1	909505 01000	Filterpatrone, Filter cartridge, Cartouche Filtrante, Cartuccia filtro, Cartucho de filtro

<sup>2)</sup> erforderliche Bestellmenge / necessary order quantity / quantité nécessaire / quantità di ordinazione necessari / cantidad necesario

VX 4.25  
 VX 4.40

Standard



Variante

**VX 4.25/XX**

①

- 1~ Einphasenwechselstrom
- 1~ single-phase AC
- 1~ AC monophasé
- 1~ AC monofase
- 1~ AC monofásica

② /0-44

- mit externen Filter
- with external filter
- avec filtre externe
- con filtro esterno
- con filtro externo

**VX 4.40/XX**

③

- 1~ Einphasenwechselstrom
- 1~ single-phase AC
- 1~ AC monophasé
- 1~ AC monofase
- 1~ AC monofásica

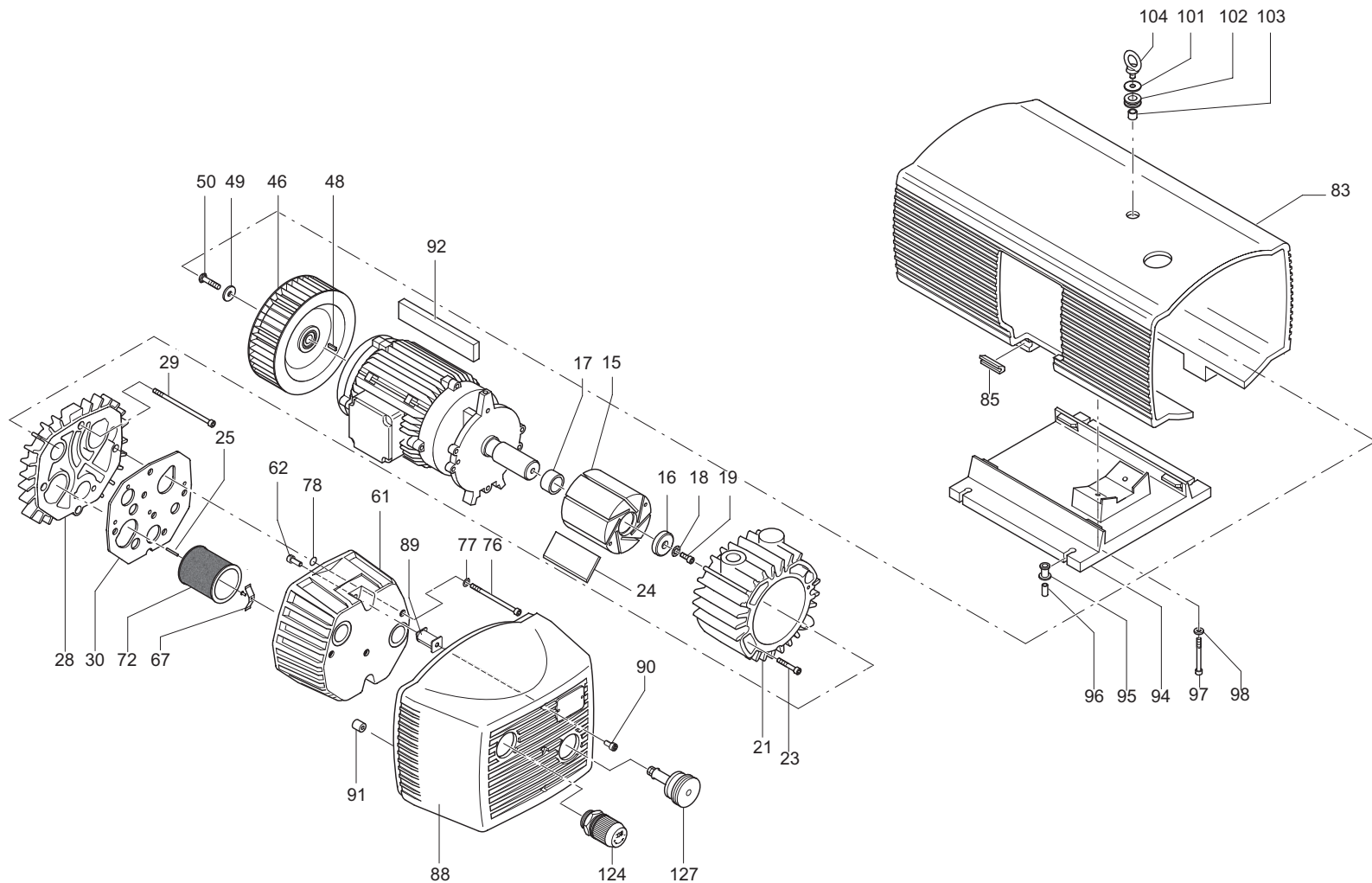
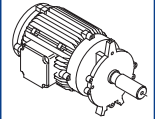
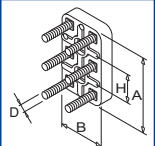
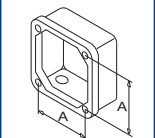
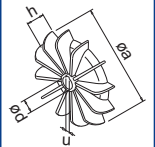
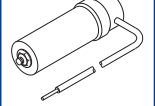

**SERVICE**

 C = ?  $\mu$ F  
 U = ? V

C INDEX	Pos.	Bestell Nr.	Beschreibung	
VX 4.25	15	020000 50300	KOLBEN	
	16	016800 16500	SPANNSCHEIBE	
	17	911012 00000	STAR-TOLERANZRING	
	18	949203 00000	ZAHNSCHEIBE	
	19	945320 00000	INNENSECHSKANTSCHRAUBE	
	21	000101 16400	GEHÄUSE	
	23	945320 00000	INNENSECHSKANTSCHRAUBE	
	24	901399 00007	<b>SCHIEBER, KOHLE (SATZ)</b>	
	25	952009 00000	SPANNHÜLSE	
	28	000710 16500	SEITENDECKEL	
	29	945373 00000	INNENSECHSKANTSCHRAUBE	
	30	008900 16500	DICHTUNG	
	46	502301 16400	VENTILATOR MIT NABE	
	48	947713 00000	PASSFEDER	
	49	949454 00000	U-SCHEIBE	
	50	901804 00000	WELLENENDSCHRAUBE TUFLOK	
	61	004804 27600	FILTERDECKEL	
	62	945319 00000	INNENSECHSKANTSCHRAUBE	
	67	009000 16300	ANPRESSFEDER	
	72	909505 01000	<b>FILTERPATRONE (1x)<sup>1)</sup></b>	
	76	945373 00000	INNENSECHSKANTSCHRAUBE	
	77	948021 00000	DICHTRING	
	78	913161 00000	O-RING	
	83	006805 27500	GERÄTEHAUBE	
	85	951920 00000	GUMMIFORMTEIL	
	88	006802 27600	GERÄTEHAUBE	
	89	741300 27601	DÄMMAUFLAGE	
90	945318 00000	INNENSECHSKANTSCHRAUBE		
91	951922 00000	GUMMIFORMTEIL		
92	964110 00000	KANTENSCHUTZ		
94	015100 27600	FUSS		
95	951921 00000	GUMMIFORMTEIL		
96	068000 27600	DISTANZSTÜCK		
97	945328 00000	INNENSECHSKANTSCHRAUBE		
98	949451 00000	UNTERLEGSCHNEIBE		
101	833903 99597	VENTILTELLER		
102	951906 00000	KABELTÜLLE		
103	068002 16500	DISTANZROHR		
104	548800 16300	RINGSCHRAUBE		
124	736001 99613	VAKUUMREGULIERVENTIL		
127	727502 06000	ABBLASEVENTIL		

<sup>1)</sup>erforderliche Bestellmenge / Wartung

C INDEX	Pos.	Bestell Nr.	Beschreibung	
VX 4.40	15	020000 50400	KOLBEN	
	16	016800 16500	SPANNSCHEIBE	
	17	911008 00000	STAR-TOLERANZRING	
	18	949203 00000	ZAHNSCHEIBE	
	19	945320 00000	INNENSECHSKANTSCHRAUBE	
	21	000102 16500	GEHÄUSE	
	23	945322 00000	INNENSECHSKANTSCHRAUBE	
	24	901397 00007	<b>SCHIEBER, KOHLE (SATZ)</b>	
	25	952009 00000	SPANNHÜLSE	
	28	000710 16500	SEITENDECKEL	
	29	945374 00000	INNENSECHSKANTSCHRAUBE	
	30	008900 16500	DICHTUNG	
	46	902300 26200	VENTILATOR MIT NABE	
	48	947713 00000	PASSFEDER	
	49	949454 00000	U-SCHEIBE	
	50	901804 00000	WELLENENDSCHRAUBE TUFLOK	
	61	004804 27600	FILTERDECKEL	
	62	945319 00000	INNENSECHSKANTSCHRAUBE	
	67	009000 16300	ANPRESSFEDER	
	72	909505 01000	<b>FILTERPATRONE (1x)<sup>1)</sup></b>	
	76	945373 00000	INNENSECHSKANTSCHRAUBE	
	77	948021 00000	DICHTRING	
	78	913161 00000	O-RING	
	83	006801 27600	GERÄTEHAUBE	
	85	951920 00000	GUMMIFORMTEIL	
	88	006802 27600	GERÄTEHAUBE	
	89	741300 27601	DÄMMAUFLAGE	
90	945318 00000	INNENSECHSKANTSCHRAUBE		
91	951922 00000	GUMMIFORMTEIL		
92	964109 00000	KANTENSCHUTZ		
94	015100 27600	FUSS		
95	951921 00000	GUMMIFORMTEIL		
96	068000 27600	DISTANZSTÜCK		
97	945328 00000	INNENSECHSKANTSCHRAUBE		
98	949451 00000	UNTERLEGSCHNEIBE		
101	833903 99597	VENTILTELLER		
102	951906 00000	KABELTÜLLE		
103	068002 16500	DISTANZROHR		
104	548800 16300	RINGSCHRAUBE		
124	736001 99613	VAKUUMREGULIERVENTIL		
127	727502 06000	ABBLASEVENTIL		

<sup>1)</sup>erforderliche Bestellmenge / Wartung

C INDEX	Pos.	Ident No.	Description	
VX 4.25	15	020000 50300	ROTOR	
	16	016800 16500	CLAMPING DISC	
	17	911012 00000	STAR-TOLERANCE-RING	
	18	949203 00000	TOOTHED SPRING WASHER	
	19	945320 00000	SOCKET HEAD SCREW	
	21	000101 16400	PUMP BODY	
	23	945320 00000	SOCKET HEAD SCREW	
	24	901399 00007	<b>CARBON VANES (KIT)</b>	
	25	952009 00000	LOCATING PIN	
	28	000710 16500	LID	
	29	945373 00000	SOCKET HEAD SCREW	
	30	008900 16500	GASKET	
46	502301 16400	FAN		
48	947713 00000	KEY		
49	949454 00000	WASHER		
50	901804 00000	SHAFT END BOLT		
61	004804 27600	FILTER COVER		
62	945319 00000	SOCKET HEAD SCREW		
67	009000 16300	BLADE SPRING		
72	909505 01000	<b>FILTER CARTRIDGE (1x)<sup>1)</sup></b>		
76	945373 00000	SOCKET HEAD SCREW		
77	948021 00000	SEALING RING		
78	913161 00000	O-RING		
83	006805 27500	PROTECTING HOOD		
85	951920 00000	RUBBER ELEMENT		
88	006802 27600	PROTECTING HOOD (FRONT)		
89	741300 27601	VIBRATION DAMPER		
90	945318 00000	SOCKET HEAD SCREW		
91	951922 00000	RUBBER ELEMENT		
92	964110 00000	EDGE PROTECTION		
94	015100 27600	FOOT		
95	951921 00000	RUBBER ELEMENT		
96	068000 27600	SPACING COLLAR		
97	945328 00000	SOCKET HEAD SCREW		
98	949451 00000	WASHER		
101	833903 99597	DISC		
102	951906 00000	RUBBER BUSHING		
103	068002 16500	SPACER TUBE		
104	548800 16300	EYE SCREW		
124	736001 99613	VACUUM REGULATING VALVE		
127	727502 06000	BLOW-OFF VALVE		

<sup>1)</sup> necessary order quantity / maintenance

C INDEX	Pos.	Ident No.	Description	
VX 4.40	15	020000 50400	ROTOR	
	16	016800 16500	CLAMPING DISC	
	17	911008 00000	STAR-TOLERANCE-RING	
	18	949203 00000	TOOTHED SPRING WASHER	
	19	945320 00000	SOCKET HEAD SCREW	
	21	000102 16500	PUMP BODY	
	23	945322 00000	SOCKET HEAD SCREW	
	24	901397 00007	<b>CARBON VANES (KIT)</b>	
	25	952009 00000	LOCATING PIN	
	28	000710 16500	LID	
	29	945374 00000	SOCKET HEAD SCREW	
	30	008900 16500	GASKET	
46	902300 26200	FAN		
48	947713 00000	KEY		
49	949454 00000	WASHER		
50	901804 00000	SHAFT END BOLT		
61	004804 27600	FILTER COVER		
62	945319 00000	SOCKET HEAD SCREW		
67	009000 16300	BLADE SPRING		
72	909505 01000	<b>FILTER CARTRIDGE (1x)<sup>1)</sup></b>		
76	945373 00000	SOCKET HEAD SCREW		
77	948021 00000	SEALING RING		
78	913161 00000	O-RING		
83	006801 27600	PROTECTING HOOD		
85	951920 00000	RUBBER ELEMENT		
88	006802 27600	PROTECTING HOOD (FRONT)		
89	741300 27601	VIBRATION DAMPER		
90	945318 00000	SOCKET HEAD SCREW		
91	951922 00000	RUBBER ELEMENT		
92	964109 00000	EDGE PROTECTION		
94	015100 27600	FOOT		
95	951921 00000	RUBBER ELEMENT		
96	068000 27600	SPACING COLLAR		
97	945328 00000	SOCKET HEAD SCREW		
98	949451 00000	WASHER		
101	833903 99597	DISC		
102	951906 00000	RUBBER BUSHING		
103	068002 16500	SPACER TUBE		
104	548800 16300	EYE SCREW		
124	736001 99613	VACUUM REGULATING VALVE		
127	727502 06000	BLOW-OFF VALVE		

<sup>1)</sup> necessary order quantity / maintenance

C INDICE	Pos.	No. Identification	Designation	FR	
VX 4.25	15	020000 50300	PISTON		
	16	016800 16500	DISQUE DE SERRAGE		
	17	911012 00000	BAGUE STAR		
	18	949203 00000	DENT DISQUE		
	19	945320 00000	VIS HEXAGONALE INTERNE		
	21	000101 16400	CORP DE POMPE		
	23	945320 00000	VIS HEXAGONALE INTERNE		
	24	901399 00007	<b>PALETTE DE CHARBON (KIT)</b>		
	25	952009 00000	DOVILLE DE ETRAGE		
	28	000710 16500	COUVERCLE		
	29	945373 00000	VIS HEXAGONALE INTERNE		
	30	008900 16500	JOINT		
	46	502301 16400	VENTILATEUR		
	48	947713 00000	CLAVETTE		
	49	949454 00000	RONDELLE		
	50	901804 00000	VIS BOUT D'ARBRE		
	61	004804 27600	COUVERCLE DU FILTRE		
	62	945319 00000	VIS HEXAGONALE INTERNE		
	67	009000 16300	RESSORT-JAME		
	72	909505 01000	<b>CARTOUCHE FILTRANTE (1x)<sup>1)</sup></b>		
	76	945373 00000	VIS HEXAGONALE INTERNE		
	77	948021 00000	JOINT		
	78	913161 00000	ANNEAU-O		
	83	006805 27500	CARTER PROTECTEUR		
	85	951920 00000	ELEMENT EN CAOUTCHOUC		
	88	006802 27600	CARTER PROTECTEUR		
	89	741300 27601	AMORTISSEUR DE VIBRATIONS		
90	945318 00000	VIS HEXAGONALE INTERNE			
91	951922 00000	ELEMENT EN CAOUTCHOUC			
92	964110 00000	PROTECTION D'ARETE			
94	015100 27600	PIED			
95	951921 00000	ELEMENT EN CAOUTCHOUC			
96	068000 27600	DONILLE D'ECARMENT			
97	945328 00000	VIS HEXAGONALE INTERNE			
98	949451 00000	RONDELLE			
101	833903 99597	PLATEAU DE SOUPE			
102	951906 00000	PROTECTION EN CAOUTCHOUC			
103	068002 16500	TUBE D'ECARTEMENT			
104	548800 16300	PITON			
124	736001 99613	SOUPE REGLAGE VIDE			
127	727502 06000	SILENCIEUX			

<sup>1)</sup> quantité nécessaire / entretien

C INDICE	Pos.	No. Identification	Designation	FR	
VX 4.40	15	020000 50400	PISTON		
	16	016800 16500	DISQUE DE SERRAGE		
	17	911008 00000	BAGUE STAR		
	18	949203 00000	DENT DISQUE		
	19	945320 00000	VIS HEXAGONALE INTERNE		
	21	000102 16500	CORP DE POMPE		
	23	945322 00000	VIS HEXAGONALE INTERNE		
	24	901397 00007	<b>PALETTE DE CHARBON (KIT)</b>		
	25	952009 00000	DOVILLE DE ETRAGE		
	28	000710 16500	COUVERCLE		
	29	945374 00000	VIS HEXAGONALE INTERNE		
	30	008900 16500	JOINT		
	46	902300 26200	VENTILATEUR		
	48	947713 00000	CLAVETTE		
	49	949454 00000	RONDELLE		
	50	901804 00000	VIS BOUT D'ARBRE		
	61	004804 27600	COUVERCLE DU FILTRE		
	62	945319 00000	VIS HEXAGONALE INTERNE		
	67	009000 16300	RESSORT-JAME		
	72	909505 01000	<b>CARTOUCHE FILTRANTE (1x)<sup>1)</sup></b>		
	76	945373 00000	VIS HEXAGONALE INTERNE		
	77	948021 00000	JOINT		
	78	913161 00000	ANNEAU-O		
	83	006801 27600	CARTER PROTECTEUR		
	85	951920 00000	ELEMENT EN CAOUTCHOUC		
	88	006802 27600	CARTER PROTECTEUR		
	89	741300 27601	AMORTISSEUR DE VIBRATIONS		
90	945318 00000	VIS HEXAGONALE INTERNE			
91	951922 00000	ELEMENT EN CAOUTCHOUC			
92	964109 00000	PROTECTION D'ARETE			
94	015100 27600	PIED			
95	951921 00000	ELEMENT EN CAOUTCHOUC			
96	068000 27600	DONILLE D'ECARMENT			
97	945328 00000	VIS HEXAGONALE INTERNE			
98	949451 00000	RONDELLE			
101	833903 99597	PLATEAU DE SOUPE			
102	951906 00000	PROTECTION EN CAOUTCHOUC			
103	068002 16500	TUBE D'ECARTEMENT			
104	548800 16300	PITON			
124	736001 99613	SOUPE REGLAGE VIDE			
127	727502 06000	SILENCIEUX			

<sup>1)</sup> quantité nécessaire / entretien

C INDICE	Pos.	No. Identificazione	Designazione		
VX 4.25	15	020000 50300	ROTORE		
	16	016800 16500	DISCO DI FISSAGGIO		
	17	911012 00000	STAR-ANELLO TOLLERANZA		
	18	949203 00000	DISCO A DENTE		
	19	945320 00000	VITE ESAGONALE INTERNA		
	21	000101 16400	CARCASSA		
	23	945320 00000	VITE ESAGONALE INTERNA		
	24	901399 00007	<b>PALETTE DI CHARBONE (KIT)</b>		
	25	952009 00000	SPINE DI RISCONTRO		
	28	000710 16500	COPERCHIO		
	29	945373 00000	VITE ESAGONALE INTERNA		
	30	008900 16500	GUARNIZIONE		
	46	502301 16400	VENTILATORE		
	48	947713 00000	CHIAVETTA		
	49	949454 00000	RONDELLA		
	50	901804 00000	VITE DI CHIUSURA ALBERO		
	61	004804 27600	COPERCHIO FILTRO		
	62	945319 00000	VITE ESAGONALE INTERNA		
	67	009000 16300	MOLLA		
	72	909505 01000	<b>CARTUCCIA FILTRO (1x)<sup>1)</sup></b>		
	76	945373 00000	VITE ESAGONALE INTERNA		
	77	948021 00000	ANELLO GUARNIZIONE		
	78	913161 00000	ANELLO-O		
	83	006805 27500	CAPOTO DI PRTEZIONE		
	85	951920 00000	ELEMENTO IN GOMMA		
	88	006802 27600	CARTER DI PROTEZIONE		
	89	741300 27601	AMMORTIZZATORE DI VIBRAZIONI		
90	945318 00000	VITE ESAGONALE INTERNA			
91	951922 00000	ELEMENTO IN GOMMA			
92	964110 00000	LISTELLO DI PROTEZIONE			
94	015100 27600	PIEDE			
95	951921 00000	ELEMENTO IN GOMMA			
96	068000 27600	BOCCOLA DISTANZIATRICE			
97	945328 00000	VITE ESAGONALE INTERNA			
98	949451 00000	RONDELLA			
101	833903 99597	PIATELLO DELLA VALVOLA			
102	951906 00000	PROTEZIONE IN GOMMA			
103	068002 16500	TUBO DISTANZA			
104	548800 16300	GANCIO			
124	736001 99613	VALVOLA REGOLAZIONE VUOTO			
127	727502 06000	SILENZIATORE			

<sup>1)</sup> quantità di ordinazione necessari / manutenzione

C INDICE	Pos.	No. Identificazione	Designazione		
VX 4.40	15	020000 50400	ROTORE		
	16	016800 16500	DISCO DI FISSAGGIO		
	17	911008 00000	STAR-ANELLO TOLLERANZA		
	18	949203 00000	DISCO A DENTE		
	19	945320 00000	VITE ESAGONALE INTERNA		
	21	000102 16500	CARCASSA		
	23	945322 00000	VITE ESAGONALE INTERNA		
	24	901397 00007	<b>PALETTE DI CHARBONE (KIT)</b>		
	25	952009 00000	SPINE DI RISCONTRO		
	28	000710 16500	COPERCHIO		
	29	945374 00000	VITE ESAGONALE INTERNA		
	30	008900 16500	GUARNIZIONE		
	46	902300 26200	VENTILATORE		
	48	947713 00000	CHIAVETTA		
	49	949454 00000	RONDELLA		
	50	901804 00000	VITE DI CHIUSURA ALBERO		
	61	004804 27600	COPERCHIO FILTRO		
	62	945319 00000	VITE ESAGONALE INTERNA		
	67	009000 16300	MOLLA		
	72	909505 01000	<b>CARTUCCIA FILTRO (1x)<sup>1)</sup></b>		
	76	945373 00000	VITE ESAGONALE INTERNA		
	77	948021 00000	ANELLO GUARNIZIONE		
	78	913161 00000	ANELLO-O		
	83	006801 27600	CAPOTO DI PRTEZIONE		
	85	951920 00000	ELEMENTO IN GOMMA		
	88	006802 27600	CARTER DI PROTEZIONE		
	89	741300 27601	AMMORTIZZATORE DI VIBRAZIONI		
90	945318 00000	VITE ESAGONALE INTERNA			
91	951922 00000	ELEMENTO IN GOMMA			
92	964109 00000	LISTELLO DI PROTEZIONE			
94	015100 27600	PIEDE			
95	951921 00000	ELEMENTO IN GOMMA			
96	068000 27600	BOCCOLA DISTANZIATRICE			
97	945328 00000	VITE ESAGONALE INTERNA			
98	949451 00000	RONDELLA			
101	833903 99597	PIATELLO DELLA VALVOLA			
102	951906 00000	PROTEZIONE IN GOMMA			
103	068002 16500	TUBO DISTANZA			
104	548800 16300	GANCIO			
124	736001 99613	VALVOLA REGOLAZIONE VUOTO			
127	727502 06000	SILENZIATORE			



<sup>1)</sup> quantità di ordinazione necessari / manutenzione

C INDICE	Pos.	No. De pedido	Descripción	ES	
VX 4.25	15	020000 50300	ÉMBOLO		
	16	016800 16500	ARANDELA TENSORA		
	17	911012 00000	ANILLO DE TOLERANCIA STAR		
	18	949203 00000	POLEA DENTADA		
	19	945320 00000	TORNILLO HEXAGONAL INTERIOR		
	21	000101 16400	CARCASA		
	23	945320 00000	TORNILLO HEXAGONAL INTERIOR		
	24	901399 00007	<b>EMPUJADOR DE CARBÓN (KIT)</b>		
	25	952009 00000	CASQUILLO TENSOR		
	28	000710 16500	TAPA LATERAL		
	29	945373 00000	TORNILLO HEXAGONAL INTERIOR		
	30	008900 16500	JUNTA		
	46	502301 16400	VENTILADOR CON CUBO		
	48	947713 00000	LENGÜETA DE AJUSTE		
	49	949454 00000	ARANDELA		
	50	901804 00000	TORNILLO TERMINAL DE ÁRBOL TUFLOK		
	61	004804 27600	TAPA DE FILTRO		
	62	945319 00000	TORNILLO HEXAGONAL INTERIOR		
	67	009000 16300	MUELLE DE PRESIÓN		
	72	909505 01000	<b>CARTUCHO DE FILTRO (1x)<sup>1)</sup></b>		
	76	945373 00000	TORNILLO HEXAGONAL INTERIOR		
	77	948021 00000	ANILLO DE JUNTA		
	78	913161 00000	JUNTA TÓRICA		
	83	006805 27500	CAPERUZA DE APARATO		
	85	951920 00000	PIEZA DE ORMA DE GOMA		
	88	006802 27600	CAPERUZA DE APARATO		
	89	741300 27601	AMORTIGUADOR DE VIBRACIONES		
90	945318 00000	TORNILLO HEXAGONAL INTERIOR			
91	951922 00000	PIEZA DE ORMA DE GOMA			
92	964110 00000	PROTECCIÓN DE CANTOS			
94	015100 27600	PIE			
95	951921 00000	PIEZA DE ORMA DE GOMA			
96	068000 27600	PIEZA DISTANCIADORA			
97	945328 00000	TORNILLO HEXAGONAL INTERIOR			
98	949451 00000	ARANDELA			
101	833903 99597	PLATILLO DE VÁLVULA			
102	951906 00000	BOQUILLA DE CABLE			
103	068002 16500	TUBO DISTANCIADOR			
104	548800 16300	TORNILLO DE CÁNCAMO			
124	736001 99613	VÁLVULA REGULADORA DE VACÍO			
127	727502 06000	VÁLVULA DE BARRIDO			

<sup>1)</sup> cantidad necesario / mantenimiento

C INDICE	Pos.	No. De pedido	Descripción	ES	
VX 4.40	15	020000 50400	ÉMBOLO		
	16	016800 16500	ARANDELA TENSORA		
	17	911008 00000	ANILLO DE TOLERANCIA STAR		
	18	949203 00000	POLEA DENTADA		
	19	945320 00000	TORNILLO HEXAGONAL INTERIOR		
	21	000102 16500	CARCASA		
	23	945322 00000	TORNILLO HEXAGONAL INTERIOR		
	24	901397 00007	<b>EMPUJADOR DE CARBÓN (KIT)</b>		
	25	952009 00000	CASQUILLO TENSOR		
	28	000710 16500	TAPA LATERAL		
	29	945374 00000	TORNILLO HEXAGONAL INTERIOR		
	30	008900 16500	JUNTA		
	46	902300 26200	VENTILADOR CON CUBO		
	48	947713 00000	LENGÜETA DE AJUSTE		
	49	949454 00000	ARANDELA		
	50	901804 00000	TORNILLO TERMINAL DE ÁRBOL TUFLOK		
	61	004804 27600	TAPA DE FILTRO		
	62	945319 00000	TORNILLO HEXAGONAL INTERIOR		
	67	009000 16300	MUELLE DE PRESIÓN		
	72	909505 01000	<b>CARTUCHO DE FILTRO (1x)<sup>1)</sup></b>		
	76	945373 00000	TORNILLO HEXAGONAL INTERIOR		
	77	948021 00000	ANILLO DE JUNTA		
	78	913161 00000	JUNTA TÓRICA		
	83	006801 27600	CAPERUZA DE APARATO		
	85	951920 00000	PIEZA DE ORMA DE GOMA		
	88	006802 27600	CAPERUZA DE APARATO		
	89	741300 27601	AMORTIGUADOR DE VIBRACIONES		
90	945318 00000	TORNILLO HEXAGONAL INTERIOR			
91	951922 00000	PIEZA DE ORMA DE GOMA			
92	964109 00000	PROTECCIÓN DE CANTOS			
94	015100 27600	PIE			
95	951921 00000	PIEZA DE ORMA DE GOMA			
96	068000 27600	PIEZA DISTANCIADORA			
97	945328 00000	TORNILLO HEXAGONAL INTERIOR			
98	949451 00000	ARANDELA			
101	833903 99597	PLATILLO DE VÁLVULA			
102	951906 00000	BOQUILLA DE CABLE			
103	068002 16500	TUBO DISTANCIADOR			
104	548800 16300	TORNILLO DE CÁNCAMO			
124	736001 99613	VÁLVULA REGULADORA DE VACÍO			
127	727502 06000	VÁLVULA DE BARRIDO			

<sup>1)</sup> cantidad necesario / mantenimiento

VX 4.25 VX 4.40	Variante 	Pos. <sup>2)</sup>	Bestell Nr. / Ident No. / No. Identification / No. Identificazione / No. De pedido		Beschreibung / Description / Designation / Designazione / Descripcion
					
<b>VX 4.25</b>					
① 1~ Einphasenwechselstrom 1~ single-phase AC 1~ AC monophasé 1~ AC monofase 1~ AC monofásica		8	964233 00000		WINKEL / BRACKET / COUDES / GOMITO / ÁNGULO
		12	948766 00000		BLINDNIET / BLIND RIVET / RIVET AVEUGLIE / RIVETTO CIECO / REMACHE CIEGO
		13	742002 30000		KABEL / CABLE / CABLE / CAVO / CABLE
		83	006806 27500	<del>006805-27500</del>	HAUBE / PROTECTING HOOD / CARTER PROTECTEUR / CARTER DI PROTEZIONE / CAPERUZA
		94	015101 27600	<del>015100-27600</del>	FUSS / FOOT / PIED / PIEDE / PIE
<b>② /0-44</b>					
3~ ohne Filterung 3~ without filter 3~ sans filtre 3~ senza filtro 3~ sin filtro		25		<del>952009-00000</del>	SPANNHÜLSE / LOCATING PIN / DOVILLE DE ETRAGE / SPINE DI RISCONTRO / CASQUILLO TENSOR
		67		<del>009000-16300</del>	ANPRESSFEDER / LEAF SPRING / RESSORT-JAME / MOLLA / MUELLE DE PRESIÓN
		72		<del>909505-01000</del>	FILTERPATRONE / FILTER CARTRIDGE / CARTOUCHE FILTRANTE / CARTUCCIA FILTRO / CARTUCHO DE FILTRO
		173	840401 05000		FILTERPATRONE FÜR EXTERNEN FILTER (F10) / FILTER CARTRIDGE FOR EXTERNAL FILTER (F10) / CARTOUCHE FILTRANTE POUR FILTRE EXTERNE (F10) / CARTUCCIA FILTRO PER FILTRO ESTERNO (F10) / CARTUCHO DE FILTRO DE FILTRO EXTERNO (F10)
<b>VX 4.40</b>					
③ 1~ Einphasenwechselstrom 1~ single-phase AC 1~ AC monophasé 1~ AC monofase 1~ AC monofásica		8	964233 00000		WINKEL / BRACKET / COUDES / GOMITO / ÁNGULO
		12	948766 00000		BLINDNIET / BLIND RIVET / RIVET AVEUGLIE / RIVETTO CIECO / REMACHE CIEGO
		13	742002 30000		KABEL / CABLE / CABLE / CAVO / CABLE
		83	006805 27600	<del>006801-27600</del>	HAUBE / PROTECTING HOOD / CARTER PROTECTEUR / CARTER DI PROTEZIONE / CAPERUZA
		94	015101 27600	<del>015100-27600</del>	FUSS / FOOT / PIED / PIEDE / PIE

<sup>2)</sup> variantenabhängige Bauteile / variant-dependent components / composants variante-dependantes / componenti variante-dispendenti / componentes variante-dependientes