

U 5.70

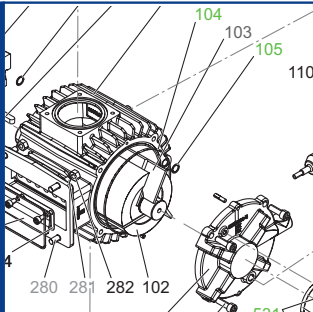

SERVICE

BECKER
D-42279 Wuppertal
www.becker-international.com

No. **A** year XXXX

type **U 5.70-XX** Index Variante

frequency XXXX Hz
speed XXXX min⁻¹
power required XXXX kW
inlet capacity XXXX m³/h
pressure + XXXX mbar
vacuum - XXXX mbar

Made in Germany



Ersatzteilliste
Spare parts list
Liste de pièces de rechange
Listino pezzi di ricambio
Lista de piezas de recambio
Lista de peças sobresselentes
Reserveonderdelenlijst
Atsarginių dalių sąrašas
Varuosad nimekirja
Rezerves daļu saraksts

Reservedelsliste
Reservdelslista
Varaosuettelo
Reservedelsliste
Wykaz części zamiennych
Tartalékalkatrész lista
Seznam náhradních dílů
Seznam nadomestnih delov
Zoznam náhradných dielov
Rezervni dijelovi popis

Lista pieselor de schimb
Páirteanna spártha liosta
Κατάλογος ανταλλακτικών
Yedek parça listesi
Списък на резервните части
Перечень запасных частей
スベーパーツリスト
예비 부품 목록
备用零件目录

28000054100 06/2018

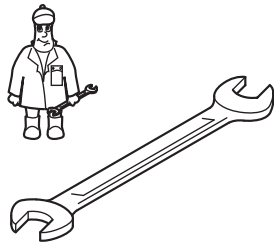

Wartung
Maintenance
Entretien
Manutenzione
Mantenimiento

Pos.	Menge Quantity Quantité Quantità Cantidad	Bestell-Nr. Ident No. No. Identification No. Identificazione No. de pedido	Bezeichnung Description Designation Designazione Descripción
K1	1	566500 54200	Wartungssatz, Maintenance kit, Kit de maintenance, Kit di manutenzione, Kit de mantenimiento
K2	1	549000 54200	Dichtungssatz, Complete set of seals, Jeu de joints complet, Kit di guarnizioni completo, Kit de juntas completo
K3	1	566100 54200	Ölschauglassatz, Oil sight glass kit, Ensemble de voyant d'huile, Kit di spia livello olio, Kit de mirilla de aceite
K4	1	566300 54200	Reparatursatz, Repair kit, Kit de réparation, Kit di riparazione, Kit de reparación
K5	1	966900 54200	Schraubensatz, Screw kit, Kit de visserie, Kit di viti, Kit de tornillo
¹⁾	1 l	960009 00000	BECKER LUBE M 100 (Mineralöl, mineral oil, huile minérale, olio minerale, aceite mineral)
	5 l	960009 00200	
	1 l	960016 00100	
5 l	960016 00200		
	1 l	960023 00100	BECKER LUBE SL 100 (Lebensmittelbereich, food sector, secteur de l'alimentation, settore alimentare, sector alimentario)
	5 l	960023 00200	

¹⁾ Füllmenge / filling capacity / capacité de remplissage / capacità di riempimento / capacidad de llenado U 5.70 = 2 l (max.), U 5.70/0-60 = 3 l (max.)

U 5.70

Standard



Variante



U 5.70/XX

①

U 5.70/0-60

- Sonderausführung
- Special version
- Version spéciale
- Modello speciale
- Modelo especial

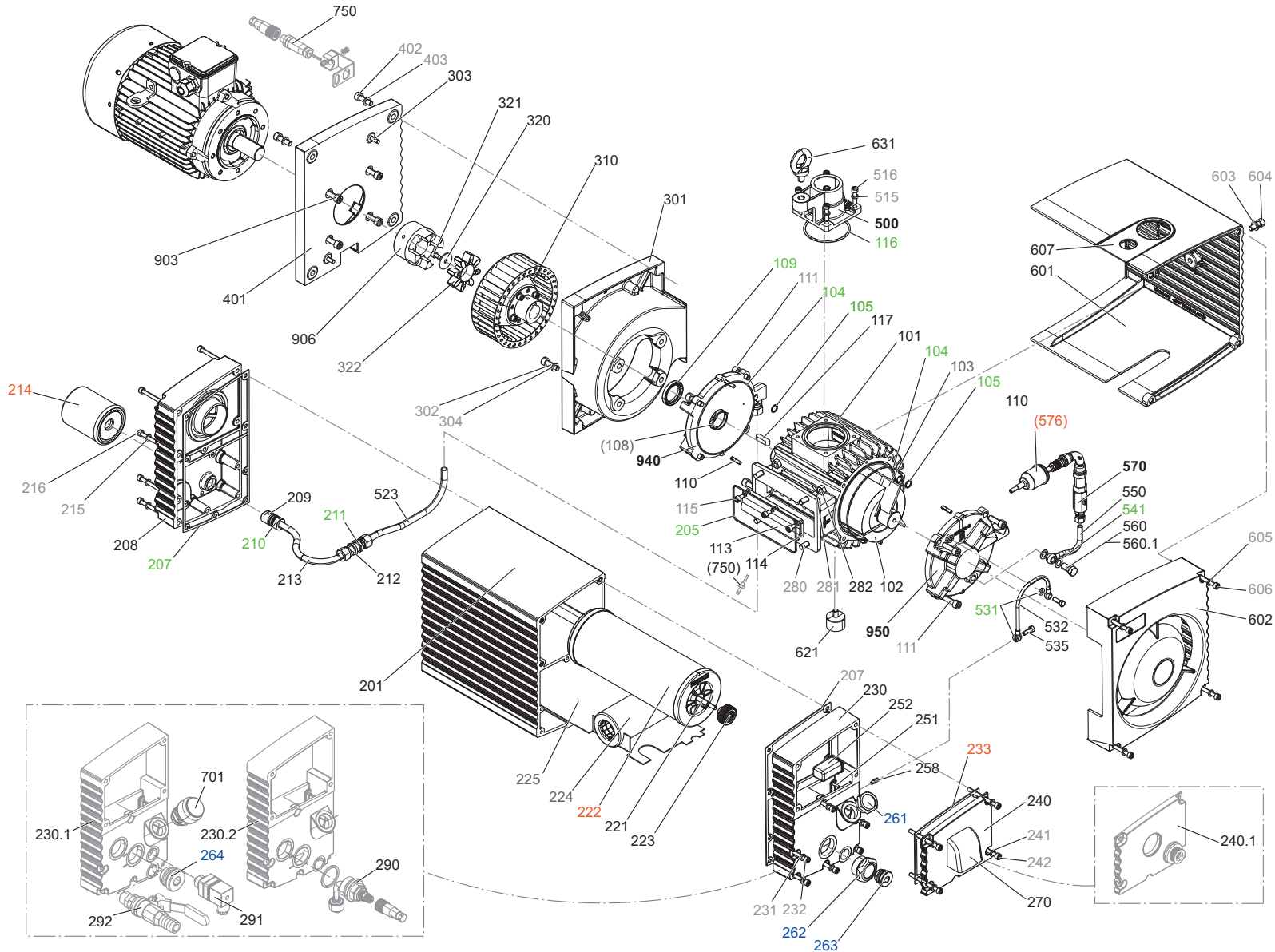

SERVICE ?

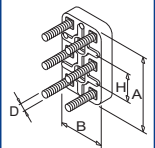
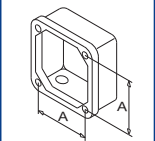
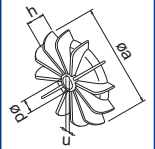
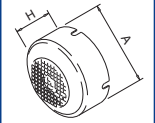
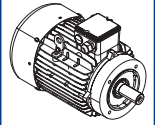

A INDEX	Pos.	Bestell Nr.	Beschreibung	
U 5.70	K1	566500 54200	WARTUNGSATZ ¹⁾	
	K2	549000 54200	DICHTUNGSSATZ ²⁾	
	K3	566100 54200	ÖLSCHAUGLASSSATZ ³⁾	
	K3.1	566101 54200	ÖLSCHAUGLASSSATZ - U5.70/0-60 ^{3.1)}	
	K4	566300 54200	REPARATURSATZ ⁴⁾	
	K5	966900 54200	SCHRAUBENSATZ ⁵⁾	
	101	000100 54100	GEHÄUSE	
	102	020000 54200	KOLBEN	
	103	K4 (900510 00003)	SCHIEBERSATZ	
	104	K2, K4	O-RING	
	105	K2, K4	O-RING	
	108	K4	GLEITLAGER	
	109	K2, K4	WELLENDICHRING	
	110	948742 00000	PASSKERBSTIFT	
	111	K5	INNENSECHSKANTSCHRAUBE - M8X25	
	113	029100 54200	VENTILFÄNGER	
	114	033900 54200	VENTILPLATTE	
	115	K5	INNENSECHSKANTSCHRAUBE - M6X10	
	116	K2, K4	O-RING	
	117	947732 00000	PASSFEDER	
	201	002400 54200	ÖLBEHÄLTER	
	205	K2, K4	O-RING	
	207	K2, K4	DICHTUNG	
	208	001700 54200	ÖLBEHÄLTERDECKEL HINTEN	
	209	064800 54200	ADAPTER	
	210	K2, K4	O-RING	
	211	K2, K4	SCHEIBE	
	212	936352 00000	GERADE SCHOTTVERSCHRAUBUNG	
	213	012200 54200	LEITUNG INTERN	
	214	K1, K4	ÖLFILTER	
	215	K5	SCHEIBE	
	216	K5	INNENSECHSKANTSCHRAUBE - M6X50	
	221	034103 99628	ANKERSCHRAUBE	
	222	K1, K4	LUFTENTÖLELEMENT	
	223	921500 50000	HANDGRIFF	
	224	K4	GROBABSCHIEDER	
	225	K4	FILTERBLECH	
	230	002500 54200	SERVICE-DECKEL (STANDARD)	
	230.1	002501 54200	SERVICE-DECKEL (VARIANTE 1)	
	230.2	002502 54200	SERVICE-DECKEL (VARIANTE 2)	
	231	K5	SCHEIBE	
	232	K5	INNENSECHSKANTSCHRAUBE - M6X50	
	233	K1, K2, K4	DICHTUNG	
	240	003700 54200	WARTUNGSDECKEL (STANDARD)	
	240.1	503700 54200	WARTUNGSDECKEL (MIT ABLUFTANSCHLUSS UND VENTIL)	
	241	K5	SCHEIBE	
	242	K5	INNENSECHSKANTSCHRAUBE M6X65	
	251	034100 99559	GELENKBOLZEN	
	252	567803 99559	SCHWIMMER	
	258	003300 54200	DÜSE	
	261	K3, K4	SCHRAUBDECKEL	
	262	K3, K4	ÖLSCHAUGLAS MIT DICHTUNG	
	263	K3, K4	VERSCHLUSSSCHRAUBE	
	264	951221 00100	VERSCHLUSSSCHRAUBE - OPTIONAL	
	270	034900 54200	UMLENKKAPPE	
	280	K5	STIFTSCHRAUBE - M8X20	
	281	K5	SCHEIBE	
	282	947105 00000	SECHSKANTMUTTER	

A INDEX	Pos.	Bestell Nr.	Beschreibung	
	290	741107 99682	NIVEAUGEBER - OPTIONAL	
	291	743421 04000	TEMPERATURWÄCHTER - OPTIONAL	
	292	521601 99400	KUGELHAHN (MIT SCHLAUCHANSCHLUSS 19mm) ⁶⁾	
	301	053200 54200	LATERNE	
	302	K5	INNENSECHSKANTSCHRAUBE - M8X25	
	303	947628 01000	ZYLINDERSTIFT	
	304	K5	SCHEIBE	
	310	502300 54200	KUPPLUNGSHÄLFTE MIT VENTILATOR	
	320	016801 54200	SPANNSCHEIBE	
	321	901809 00000	WELLENENDSCHRAUBE	
	322	K4	KUPPLUNGSSCHEIBE	
		(902200 54200)		
	401	014900 54100	MOTORFLANSCH	
	402	K5	INNENSECHSKANTSCHRAUBE - M8X25	
	403	K5	SCHEIBE	
	500	537501 54200	SAUGVENTIL KOMPLETT	
	515	K5	SCHEIBE	
	516	K5	INNENSECHSKANTSCHRAUBE - M6X25	
	523	960201 54200	ÖLLEITUNG	
	531	K2, K4	SCHEIBE	
	532	012219 26200	RÜCKSAUGLEITUNG	
	535	009400 19000	KUGELSTÜCKSCHRAUBE	
	541	K2, K4	KUPFERRING	
	550	012203 54200	GASBALLASTLEITUNG	
	560	548400 54200	HOHLSCHRAUBE MIT DÜSE (STANDARD)	
	560.1	548401 54200	HOHLSCHRAUBE MIT DÜSE (BEI HÖHERER LUFTFEUCHTIGKEIT)	
	570	768750 99626	GASBALLAST KOMPLETT	
	576	K1, K4	FILTERPATRONE	
	601	018301 54200	HAUBE	
	602	020800 54200	LUFTLEITHAUBE	
	603	K5	SCHEIBE	
	604	K5	INNENSECHSKANTSCHRAUBE - M8X20	
	605	K5	SCHEIBE	
	606	K5	INNENSECHSKANTSCHRAUBE - M6X65	
	607	067100 54200	SAUGVENTILDECKEL	
	621	741310 60000	GUMMI PUFFER	
	631	948802 00000	RINGSCHRAUBE	
	701	916801 99691	WARTUNGSANZEIGER - OPTIONAL	
	750	543403 00000	TEMPERATURFÜHLER / ANBAUSATZ - OPTIONAL	
	903	945331 00000	INNENSECHSKANTSCHRAUBE - M8X25	
	906	902100 54100	KUPPLUNGSNABE ANTRIEBSSEITIG	
	940	500800 54200	SEITENDECKEL KOMPLETT, A-SEITE	
	950	500700 54200	SEITENDECKEL KOMPLETT, B-SEITE	

¹⁾ **K1** - 566500 54200 → Pos.: 214, 222, 233, 576

²⁾ **K2** - 549000 54200 → Pos.: 104, 105, 109, 116, 205, 207, 210, 211, 233, 531, 541

³⁾ **K3** - 566100 54200 → Pos.: 261, 262, 263

^{3.1)} **K3** - 566100 54200 → Pos.: 261, 262, 263, 264

⁴⁾ **K4** - 566300 54200 → Pos.: **K1, K2, K3** + 103, 108, 224, 225, 322

⁵⁾ **K5** - 966900 54200 → Pos.: 111, 115, 215, 216, 231, 232, 241, 242, 280, 281, 302, 304, 402, 403, 515, 516, 603, 604, 605, 606

⁶⁾ Bei nachträglicher Montage bitte einkleben!

A INDEX	Pos.	Ident No.	Description	
U 5.70	K1	566500 54200	MAINTENANCE KIT ¹⁾	
	K2	549000 54200	SET OF SEALS ²⁾	
	K3	566100 54200	OIL SIGHT GLASS KIT ³⁾	
	K3.1	566101 54200	OIL SIGHT GLASS KIT - U5.70/0-60 ^{3.1)}	
	K4	566300 54200	REPAIR KIT ⁴⁾	
	K5	966900 54200	SCREW KIT ⁵⁾	
	101	000100 54100	PUMP BODY	
	102	020000 54200	ROTOR	
	103	K4 (900510 00003)	ROTOR VANE KIT	
	104	K2, K4	O-RING SEAL	
	105	K2, K4	O-RING SEAL	
	108	K4	SLIDE BEARING	
	109	K2, K4	SHAFT SEALING RING	
	110	948742 00000	GROOVED PIN	
	111	K5	HEX HEAD SCREW - M8X25	
	113	029100 54200	VALVE KEEPER	
	114	033900 54200	VALVE PLATE	
	115	K5	HEX HEAD SCREW - M6X10	
	116	K2, K4	O-RING SEAL	
	117	947732 00000	KEY	
	201	002400 54200	OIL TANK	
	205	K2, K4	O-RING SEAL	
	207	K2, K4	GASKET	
	208	001700 54200	OIL TANK CAP	
	209	064800 54200	ADAPTER	
	210	K2, K4	O-RING SEAL	
	211	K2, K4	WASHER	
	212	936352 00000	STRAIGHT FITTING	
	213	012200 54200	PIPE	
	214	K1, K4	OIL FILTER	
	215	K5	WASHER	
	216	K5	HEX HEAD SCREW - M6X50	
	221	034103 99628	ANCHORING SCREW	
	222	K1, K4	OIL SEPARATING ELEMENT	
	223	921500 50000	HANDLE	
	224	K4	COARSE SEPARATOR	
	225	K4	FILTER STRAINER	
	230	002500 54200	SERVICE COVER (STANDARD)	
	230.1	002501 54200	SERVICE COVER (VARIANT 1)	
	230.2	002502 54200	SERVICE COVER (VARIANT 2)	
	231	K5	WASHER	
	232	K5	HEX HEAD SCREW - M6X50	
	233	K1, K2, K4	GASKET	
	240	003700 54200	MAINTENANCE COVER (STANDARD)	
	240.1	503700 54200	MAINTENANCE COVER (WITH BLOW-OFF CONNECTION AND VALVE)	
	241	K5	WASHER	
	242	K5	HEX HEAD SCREW M6X65	
	251	034100 99559	PIVOT PIN	
	252	567803 99559	FLOAT	
	258	003300 54200	NOZZLE	
	261	K3, K4	SCREW CAP	
	262	K3, K4	OIL SIGHT GLASS WITH GASKET	
	263	K3, K4	SCREW PLUG	
	264	951221 00100	SCREW PLUG - OPTIONAL	
	270	034900 54200	DIVERTER	
	280	K5	STUD - M8X20	
	281	K5	WASHER	
	282	947105 00000	HEX-NUT	

A INDEX	Pos.	Ident No.	Description	
	290	741107 99682	LEVEL TRANSMITTER - OPTIONAL	
	291	743421 04000	THERMOSTAT - OPTIONAL	
	292	521601 99400	BALL VALVE (WITH HOSE CONNECTION 19mm) ⁶⁾	
	301	053200 54200	CONNECTION FLANGE	
	302	K5	HEX HEAD SCREW - M8X25	
	303	947628 01000	CYLINDER PIN	
	304	K5	WASHER	
	310	502300 54200	COUPLING WITH FAN	
	320	016801 54200	TIGHTENING DISC	
	321	901809 00000	SHAFT END BOLD	
	322	K4	COUPLING DISC	
		(902200 54200)		
	401	014900 54100	MOTOR FLANGE	
	402	K5	HEX HEAD SCREW - M8X25	
	403	K5	WASHER	
	500	537501 54200	SUCTION VALVE COMPLETELY	
	515	K5	WASHER	
	516	K5	HEX HEAD SCREW - M6X25	
	523	960201 54200	OIL PIPE	
	531	K2, K4	WASHER	
	532	012219 26200	OIL RETURN PIPE	
	535	009400 19000	HOLLOW HOLDING SCREW	
	541	K2, K4	COPPER SEALING RING	
	550	012203 54200	GAS BALLAST PIPING	
	560	548400 54200	HOLLOW SCREW WITH NOZZLE (STANDARD)	
	560.1	548401 54200	HOLLOW SCREW WITH NOZZLE (AT HIGHER AIR HUMIDITY)	
	570	768750 99626	GAS BALLAST COMPLETELY	
	576	K1, K4	FILTER CARTRIDGE	
	601	018301 54200	HOOD	
	602	020800 54200	AIR GUIDE HOOD	
	603	K5	WASHER	
	604	K5	HEX HEAD SCREW - M8X20	
	605	K5	WASHER	
	606	K5	HEX HEAD SCREW - M6X65	
	607	067100 54200	SUCTION VALVE COVER	
	621	741310 60000	BUMPER	
	631	948802 00000	EYE BOLT	
	701	916801 99691	MAINTENANCE INDICATOR - OPTIONAL	
	750	543403 00000	TEMPERATURE SENSOR / MOUNTING KIT - OPTIONAL	
	903	945331 00000	HEX HEAD SCREW - M8X25	
	906	902100 54100	COUPLING (MOT)	
	940	500800 54200	SIDE SHIELD COMPLETELY, DRIVE SIDE	
	950	500700 54200	SIDE SHIELD COMPLETELY	

¹⁾ **K1** - 566500 54200 → Pos.: 214, 222, 233, 576

²⁾ **K2** - 549000 54200 → Pos.: 104, 105, 109, 116, 205, 207, 210, 211, 233, 531, 541

³⁾ **K3** - 566100 54200 → Pos.: 261, 262, 263

^{3.1)} **K3** - 566100 54200 → Pos.: 261, 262, 263, 264

⁴⁾ **K4** - 566300 54200 → Pos.: **K1, K2, K3** + 103, 108, 224, 225, 322

⁵⁾ **K5** - 966900 54200 → Pos.: 111, 115, 215, 216, 231, 232, 241, 242, 280, 281, 302, 304, 402, 403, 515, 516, 603, 604, 605, 606

⁶⁾ Please glue in case of subsequent installation!

A INDICE	Pos.	No. Identification	Designation
U 5.70	K1	566500 54200	KIT DE MAINTENANCE ¹⁾
	K2	549000 54200	JEU DE JOINTS ²⁾
	K3	566100 54200	ENSEMBLE DE VOYANT D'HUILE ³⁾
	K3.1	566101 54200	ENSEMBLE DE VOYANT D'HUILE - U5.70/0-60 ^{3.1)}
	K4	566300 54200	KIT DE RÉPARATION ⁴⁾
	K5	966900 54200	KIT DE VISSERIE ⁵⁾
	101	000100 54100	CORP DE POMPE
	102	020000 54200	PISTON
	103	K4 (900510 00003)	KIT DE PALETTES
	104	K2, K4	JOINT TORIQUE
	105	K2, K4	JOINT TORIQUE
	108	K4	PALIER LISSE
	109	K2, K4	BAGUE D'ÉTANCHEITÉ
	110	948742 00000	GOUPILLE CANNELÉE
	111	K5	VIS ALLEN - M8X25
	113	029100 54200	PLAQUE D'ARRÊT
	114	033900 54200	PLAQUE DES VANNES
	115	K5	VIS ALLEN - M6X10
	116	K2, K4	JOINT TORIQUE
	117	947732 00000	CLAVETTE
	201	002400 54200	RÉSERVOIR D'HUILE
	205	K2, K4	JOINT TORIQUE
	207	K2, K4	JOINT
	208	001700 54200	COUVERCLE DU RÉSERVOIR D'HUILE
	209	064800 54200	ADAPTATEUR
	210	K2, K4	JOINT TORIQUE
	211	K2, K4	RONDELLE
	212	936352 00000	RACCORD À VIS
	213	012200 54200	TUYAU
	214	K1, K4	FILTRE D'HUILE
	215	K5	RONDELLE
	216	K5	VIS ALLEN - M6X50
	221	034103 99628	VIS D'ANCRAGE
	222	K1, K4	ELEMENT SEPARATION HUILE
	223	921500 50000	POIGNEE
	224	K4	SEPARATEUR A GROS
	225	K4	LAMIERA DA FILTRO
	230	002500 54200	COUVERCLE DE SERVICE (STANDARD)
	230.1	002501 54200	COUVERCLE DE SERVICE (VARIANTE 1)
	230.2	002502 54200	COUVERCLE DE SERVICE (VARIANTE 2)
	231	K5	RONDELLE
	232	K5	VIS ALLEN - M6X50
	233	K1, K2, K4	JOINT
	240	003700 54200	COUVERCLE DE MAINTENANCE (STANDARD)
	240.1	503700 54200	" (AVEC CONNEXION D'ÉCHAPPEMENT ET SOUPE)
	241	K5	RONDELLE
	242	K5	VIS ALLEN M6X65
	251	034100 99559	AXE DE CHARNIÈRE
	252	567803 99559	FLOTTEUR
	258	003300 54200	AJUTAGE
	261	K3, K4	COUVERCLE À VIS
	262	K3, K4	VOYANT D'HUILE AVEC JOINT
	263	K3, K4	BOUCHON FILETÉ
	264	951221 00100	BOUCHON FILETÉ - EN OPTION
	270	034900 54200	BOUCHON DE DÉFLEXION
	280	K5	GOUJON PRISONNIER - M8X20
	281	K5	RONDELLE
	282	947105 00000	ÉCROU HEXAGONAL

A INDICE	Pos.	No. Identification	Designation
	290	741107 99682	CAPTEUR DE NIVEAU - EN OPTION
	291	743421 04000	THERMOSTAT - EN OPTION
	292	521601 99400	ROBINET À ROTULE (AVEC RACCORD DE TUYAU 19mm) ⁶⁾
	301	053200 54200	BRIDE DE RACCORDEMENT
	302	K5	VIS ALLEN - M8X25
	303	947628 01000	CHEVILLE CYLINDRIQUE
	304	K5	RONDELLE
	310	502300 54200	ACCOUPLLEMENT AVEC VENTILATEUR
	320	016801 54200	RONDELLE DE SERRAGE
	321	901809 00000	VIS BOUT D'ARBRE
	322	K4	DISQUE D'ACCOUPLLEMENT
		(902200 54200)	
	401	014900 54100	BRIDE DU MOTEUR
	402	K5	VIS ALLEN - M8X25
	403	K5	RONDELLE
	500	537501 54200	SOUPE D'ASPIRATION COMPLÈTEMENT
	515	K5	RONDELLE
	516	K5	VIS ALLEN - M6X25
	523	960201 54200	TUYAU D'HUILE
	531	K2, K4	RONDELLE
	532	012219 26200	TUYAU D'HUILE
	535	009400 19000	VIS CREUSE DE FIXATION
	541	K2, K4	BAGUE D'ÉTANCHEITÉ EN CUIVRE
	550	012203 54200	TUYAU L'ESTE D'AIR
	560	548400 54200	VIS CREUSE AVEC AJUTAGE (STANDARD)
	560.1	548401 54200	VIS CREUSE AVEC AJUTAGE (PLUS HAUT HUMIDITÉ D'AIR)
	570	768750 99626	L'ESTE D'AIR COMPLÈTEMENT
	576	K1, K4	CARTOUCHE FILTRANTE
	601	018301 54200	CAPOT
	602	020800 54200	CAPOT DE CANALISATION DE L'AIR
	603	K5	RONDELLE
	604	K5	VIS ALLEN - M8X20
	605	K5	RONDELLE
	606	K5	VIS ALLEN - M6X65
	607	067100 54200	COUVERCLE DE SOUPE D'ASPIRATION
	621	741310 60000	AMORTISSEUR CAOUTCHOUC
	631	948802 00000	ANNEAU À VIS
	701	916801 99691	ENTRETIEN ANNONCEURS - EN OPTION
	750	543403 00000	CAPTEUR DE TEMPÉRATURE / KIT DE MONTAGE - EN OPTION
	903	945331 00000	VIS ALLEN - M8X25
	906	902100 54100	ACCOUPLLEMENT (MOT)
	940	500800 54200	CAPOT LATÉRAL COMPLÈTEMENT, CÔTÉ ENTRAÎNEMENT
	950	500700 54200	CAPOT LATÉRAL COMPLÈTEMENT

¹⁾ K1 - 566500 54200 → Pos.: 214, 222, 233, 576
²⁾ K2 - 549000 54200 → Pos.: 104, 105, 109, 116, 205, 207, 210, 211, 233, 531, 541
³⁾ K3 - 566100 54200 → Pos.: 261, 262, 263
^{3.1)} K3 - 566100 54200 → Pos.: 261, 262, 263, 264
⁴⁾ K4 - 566300 54200 → Pos.: K1, K2, K3 + 103, 108, 224, 225, 322
⁵⁾ K5 - 966900 54200 → Pos.: 111, 115, 215, 216, 231, 232, 241, 242, 280, 281, 302, 304, 402, 403, 515, 516, 603, 604, 605, 606
⁶⁾ S'il vous plaît coller en cas d'installation ultérieure!

A INDICE	Pos.	No. Identificazione	Designazione
U 5.70	K1	566500 54200	KIT DI MANUTENZIONE ¹⁾
	K2	549000 54200	KIT DI GUARNIZIONI ²⁾
	K3	566100 54200	KIT DI SPIA LIVELLO OLIO ³⁾
	K3.1	566101 54200	KIT DI SPIA LIVELLO OLIO - U5.70/0-60 ^{3.1)}
	K4	566300 54200	KIT DI RIPARAZIONE ⁴⁾
	K5	966900 54200	KIT DI VITI ⁵⁾
	101	000100 54100	CARCASSA
	102	020000 54200	ROTORE
	103	K4 (900510 00003)	KIT DI PALETTE
	104	K2, K4	GUARNIZIONE CIRCOLARE
	105	K2, K4	GUARNIZIONE CIRCOLARE
	108	K4	CUSCINETTO A STRISCIAMENTO
	109	K2, K4	ANELLO DI GUARNIZIONE
	110	948742 00000	SPINA SCANALATA
	111	K5	VITE ESAGONALE INTERNA - M8X25
	113	029100 54200	LIMITATORE DELLA VALVOLA
	114	033900 54200	PIASTRA VALVOLE
	115	K5	VITE ESAGONALE INTERNA - M6X10
	116	K2, K4	GUARNIZIONE CIRCOLARE
	117	947732 00000	CHIAVETTA
	201	002400 54200	SERBATOIO DELL'OLIO
	205	K2, K4	GUARNIZIONE CIRCOLARE
	207	K2, K4	GUARNIZIONE
	208	001700 54200	COPERCHIO DEL SERBATOIO OLIO
	209	064800 54200	ADATTATORE
	210	K2, K4	GUARNIZIONE CIRCOLARE
	211	K2, K4	RONDELLA
	212	936352 00000	COLLEGAMENTO A VITE
	213	012200 54200	CONDOTTO
	214	K1, K4	FILTRO D'OLIO
	215	K5	RONDELLA
	216	K5	VITE ESAGONALE INTERNA - M6X50
	221	034103 99628	CHIAVARDA D'ANCORAGGIO
	222	K1, K4	CARTUCCIA SEPARATORE OLIO
	223	921500 50000	MANETTA
	224	K4	SEPARATORE GROSSOLANO
	225	K4	STACCIO PANNO DA FILTRO
	230	002500 54200	COPERCHIO DI SERVIZIO (STANDARD)
	230.1	002501 54200	COPERCHIO DI SERVIZIO (VARIANTE 1)
	230.2	002502 54200	COPERCHIO DI SERVIZIO (VARIANTE 2)
	231	K5	RONDELLA
	232	K5	VITE ESAGONALE INTERNA - M6X50
	233	K1, K2, K4	GUARNIZIONE
	240	003700 54200	COPERCHIO DI MANUTENZIONE (STANDARD)
	240.1	503700 54200	" (CON CONNESSIONE DI SFIATO E VALVOLA)
	241	K5	RONDELLA
	242	K5	VITE ESAGONALE INTERNA M6X65
	251	034100 99559	PERNO DI SNODO
	252	567803 99559	GALLEGGIANTE
	258	003300 54200	UGELLO
	261	K3, K4	COPERCHIO A VITE
	262	K3, K4	SPIA LIVELLO OLIO CON GUARNIZIONE
	263	K3, K4	TAPPO A VITE
	264	951221 00100	TAPPO A VITE - OPTIONALE
	270	034900 54200	CAP DEFLESSIONE
	280	K5	VITE PRIGIONIERA - M8X20
	281	K5	RONDELLA
	282	947105 00000	DADO ESAGONALE

A INDICE	Pos.	No. Identificazione	Designazione
	290	741107 99682	INDICATORE DI LIVELLO - OPTIONALE
	291	743421 04000	TERMOSTATO - OPTIONALE
	292	521601 99400	VALVOLA A SFERA (CON ATTACCO PER TUBO FLESSIBILE 19mm) ⁶⁾
	301	053200 54200	FLANGIA DI RACCORDE
	302	K5	VITE ESAGONALE INTERNA - M8X25
	303	947628 01000	SPINA CILINDRICA
	304	K5	RONDELLA
	310	502300 54200	GIUNTO CON VENTILATORE
	320	016801 54200	RONDELLA DI SERRAGGIO
	321	901809 00000	VITE DI CHIUSURA ALBERO
	322	K4	DISCO GIUNTO
		(902200 54200)	
	401	014900 54100	FLANGIA MOTORE
	402	K5	VITE ESAGONALE INTERNA - M8X25
	403	K5	RONDELLA
	500	537501 54200	VALVOLA ASPIRANTE COMPLETAMENTO
	515	K5	RONDELLA
	516	K5	VITE ESAGONALE INTERNA - M6X25
	523	960201 54200	CONDOTTO OLIO
	531	K2, K4	RONDELLA
	532	012219 26200	CONDOTTO OLIO
	535	009400 19000	VITE PASSAGGIO OLIO
	541	K2, K4	ANELLO DI TENUTA DI RAME
	550	012203 54200	CONDOTTO VALVOLA DI ZAVORATRICE
	560	548400 54200	VITE CAVA CON UGELLO (STANDARD)
	560.1	548401 54200	VITE CAVA CON UGELLO (MAGGIORE UMIDITÀ DELL'ARIA)
	570	768750 99626	VALVOLA DI ZAVORATRICE COMPLETAMENTO
	576	K1, K4	CANNUCCIA FILTRANTE
	601	018301 54200	CAPOTTA
	602	020800 54200	CAPPOTTA DEL CONDOTTARIA
	603	K5	RONDELLA
	604	K5	VITE ESAGONALE INTERNA - M8X20
	605	K5	RONDELLA
	606	K5	VITE ESAGONALE INTERNA - M6X65
	607	067100 54200	COPERCHIO DI VALVOLA ASPIRANTE
	621	741310 60000	PINGENTE DI GOMMA
	631	948802 00000	VITE AD ANELLO
	701	916801 99691	INDICATORI DI MANUTENZIONE - OPTIONALE
	750	543403 00000	SENSORE DI TEMPERATURA / KIT DI MONTAGGIO - OPTIONALE
	903	945331 00000	VITE ESAGONALE INTERNA - M8X25
	906	902100 54100	GIUNTO (MOT)
	940	500800 54200	COPERCHIO LATERALE COMPLETAMENTO, LATO AZIONAMENTO
	950	500700 54200	COPERCHIO LATERALE COMPLETAMENTO

¹⁾ K1 - 566500 54200 → Pos.: 214, 222, 233, 576
²⁾ K2 - 549000 54200 → Pos.: 104, 105, 109, 116, 205, 207, 210, 211, 233, 531, 541
³⁾ K3 - 566100 54200 → Pos.: 261, 262, 263
^{3.1)} K3 - 566100 54200 → Pos.: 261, 262, 263, 264
⁴⁾ K4 - 566300 54200 → Pos.: K1, K2, K3 + 103, 108, 224, 225, 322
⁵⁾ K5 - 966900 54200 → Pos.: 111, 115, 215, 216, 231, 232, 241, 242, 280, 281, 302, 304, 402, 403, 515, 516, 603, 604, 605, 606
⁶⁾ Si prega di incollare in caso di successiva installazione!

A INDICE	Pos.	No. De pedido	Descripción	
U 5.70	K1	566500 54200	KIT DE MANTENIMIENTO ¹⁾	
	K2	549000 54200	KIT DE JUNTAS ²⁾	
	K3	566100 54200	KIT DE MIRILLA DE ACEITE ³⁾	
	K3.1	566101 54200	KIT DE MIRILLA DE ACEITE - U5.70/0-60 ^{3.1)}	
	K4	566300 54200	KIT DE REPARACIÓN ⁴⁾	
	K5	966900 54200	KIT DE TORNILLO ⁵⁾	
	101	000100 54100	CÁRCASA	
	102	020000 54200	ÉMBOLO	
	103	K4 (900510 00003)	KIT DE EMPUJADOR	
	104	K2, K4	JUNTA TOROIDAL	
	105	K2, K4	JUNTA TOROIDAL	
	108	K4	COJINETE DE ROZAMIENTO	
	109	K2, K4	ANILLO DE RETÉN RADIAL	
	110	948742 00000	PASADOR RANURADO	
	111	K5	TORNILLO HEXAGONAL INTERIOR - M8X25	
	113	029100 54200	PLACA DE TOPE	
	114	033900 54200	PLACA DE VÁLVULA	
	115	K5	TORNILLO HEXAGONAL INTERIOR - M6X10	
	116	K2, K4	JUNTA TOROIDAL	
	117	947732 00000	CHAVETA	
	201	002400 54200	RECIPIENTE DE ACEITE	
	205	K2, K4	JUNTA TOROIDAL	
	207	K2, K4	JUNTA	
	208	001700 54200	TAPA DE RECIPIENTE DE ACEITE	
	209	064800 54200	ADAPTADOR	
	210	K2, K4	JUNTA TOROIDAL	
	211	K2, K4	ARANDELA	
	212	936352 00000	RACOR ROSCADO	
	213	012200 54200	CONDUCTO	
	214	K1, K4	FILTRO DE ACEITE	
	215	K5	ARANDELA	
	216	K5	TORNILLO HEXAGONAL INTERIOR - M6X50	
	221	034103 99628	TORNILLO DE ANCLAJE	
	222	K1, K4	ELEMENTO DE DESACEITAR DE AIRE	
	223	921500 50000	EMPUÑADURA	
	224	K4	SEPARADOR DE SÓLIDOS GRUESOS	
	225	K4	CHAPA DE FILTRO	
	230	002500 54200	CUBIERTA DE SERVICIO (STANDARD)	
	230.1	002501 54200	CUBIERTA DE SERVICIO (VARIANTE 1)	
	230.2	002502 54200	CUBIERTA DE SERVICIO (VARIANTE 2)	
	231	K5	ARANDELA	
	232	K5	TORNILLO HEXAGONAL INTERIOR - M6X50	
	233	K1, K2, K4	JUNTA	
	240	003700 54200	CUBIERTA DE MANTENIMIENTO (STANDARD)	
	240.1	503700 54200	" (CON CONEXIÓN DE ESCAPE Y VÁLVULA)	
	241	K5	ARANDELA	
	242	K5	TORNILLO HEXAGONAL INTERIOR M6X65	
	251	034100 99559	BULÓN DE ARTICULACIÓN	
	252	567803 99559	FLOTADOR	
	258	003300 54200	TOBERA	
	261	K3, K4	TAPA DE ROSCA	
	262	K3, K4	CRISTAL MIRILLA DE ACEITE CON JUNTA	
	263	K3, K4	TAPÓN ROSCADO	
	264	951221 00100	TAPÓN ROSCADO - OPCIONAL	
	270	034900 54200	TAPA DE DEFLEXIÓN	
	280	K5	ESPÁRRAGO - M8X20	
	281	K5	ARANDELA	
	282	947105 00000	TUERCA HEXAGONAL	

A INDICE	Pos.	No. De pedido	Descripción	
	290	741107 99682	CODIFICADOR DE NIVEL - OPCIONAL	
	291	743421 04000	TERMOSTATO - OPCIONAL	
	292	521601 99400	VÁLVULA DE BOLA (CON CONEXIÓN DE MANGUERA DE 19mm) ⁶⁾	
	301	053200 54200	FAROL	
	302	K5	TORNILLO HEXAGONAL INTERIOR - M8X25	
	303	947628 01000	PASADOR CILÍNDRICO	
	304	K5	ARANDELA	
	310	502300 54200	ACOPLAMIENTO DE SOPLADO CON VÁLVULA	
	320	016801 54200	DISCO DE REFUERZO	
	321	901809 00000	TORNILLO TEERMINAL DE ARBOL	
	322	K4 (902200 54200)	DISCO DE ACOPLAMIENTO	
	401	014900 54100	BRIDA DEL MOTOR	
	402	K5	TORNILLO HEXAGONAL INTERIOR - M8X25	
	403	K5	ARANDELA	
	500	537501 54200	VÁLVULA DE ASPIRACIÓN COMPLETAMENTE	
	515	K5	ARANDELA	
	516	K5	TORNILLO HEXAGONAL INTERIOR - M6X25	
	523	960201 54200	CONDUCTO DE ACEITE	
	531	K2, K4	ARANDELA	
	532	012219 26200	CONDUCTO DE RETROALIMENTACIÓN DE ACEITE	
	535	009400 19000	TORNILLO DE PIEZA ESFÉRICA	
	541	K2, K4	ANILLO DE JUNTA DE COBRE	
	550	012203 54200	CONDUCTO VÁLVULA DE LASTRE DE GAS	
	560	548400 54200	TORNILLO HUECO CON TORNILLO HUECO (STANDARD)	
	560.1	548401 54200	" (MAYOR HUMEDAD DEL AIRE)	
	570	768750 99626	VÁLVULA DE LASTRE DE GAS COMPLETAMENTE	
	576	K1, K4	CARTUCHO FILTRANTE	
	601	018301 54200	CUBIERTA	
	602	020800 54200	CAPERUZA CONDUCTOR DE AIRE	
	603	K5	ARANDELA	
	604	K5	TORNILLO HEXAGONAL INTERIOR - M8X20	
	605	K5	ARANDELA	
	606	K5	TORNILLO HEXAGONAL INTERIOR - M6X65	
	607	067100 54200	CUBIERTA DE VÁLVULA DE ASPIRACIÓN	
	621	741310 60000	AMORTIGUADOR DE CAUCHO	
	631	948802 00000	TORNILLO CON ANILLA	
	701	916801 99691	INDICADORES DE MANTENIMIENTO - OPCIONAL	
	750	543403 00000	SENSOR DE TEMPERATURA / KIT DE MONTAJE - OPCIONAL	
	903	945331 00000	TORNILLO HEXAGONAL INTERIOR - M8X25	
	906	902100 54100	MITAD DE ACOPLAMIENTO (MOT)	
	940	500800 54200	CUBIERTA LATERAL COMPLETAMENTE, LADO DE ACCIONAMIENTO	
	950	500700 54200	CUBIERTA LATERAL COMPLETAMENTE	

¹⁾ K1 - 566500 54200 → Pos.: 214, 222, 233, 576

²⁾ K2 - 549000 54200 → Pos.: 104, 105, 109, 116, 205, 207, 210, 211, 233, 531, 541







³⁾ K3 - 566100 54200 → Pos.: 261, 262, 263

^{3.1)} K3 - 566100 54200 → Pos.: 261, 262, 263, 264

⁴⁾ K4 - 566300 54200 → Pos.: K1, K2, K3 + 103, 108, 224, 225, 322

⁵⁾ K5 - 966900 54200 → Pos.: 111, 115, 215, 216, 231, 232, 241, 242, 280, 281, 302, 304, 402, 403, 515, 516, 603, 604, 605, 606

⁶⁾ Por favor pegue en caso de instalación posterior

U 5.70	Variante 	Pos. ²⁾	Bestell Nr. / Ident No. / No. Identification / No. Identificazione / No. De pedido		Beschreibung / Description / Designation / Designazione / Descripcion
			  	  	
① U 5.70/0-60 - Sonderausführung - Special version - Version spéciale - Modello speciale - Modelo especial		230		002500-54200	SERVICE-DECKEL / SERVICE COVER / COUVERCLE DE SERVICE / COPERCHIO DI SERVIZIO / CUBIERTA DE SERVICIO
		230.1	002501 54200	-	SERVICE-DECKEL / SERVICE COVER / COUVERCLE DE SERVICE / COPERCHIO DI SERVIZIO / CUBIERTA DE SERVICIO
		264	951221 00100		VERSCHLUSSSCHRAUBE / SCREW PLUG / BOUCHON FILETÉ / TAPPO A VITE / TAPÓN ROSCADO
		401	014900 54200	014900-54100	MOTORFLANSCH / MOTOR FLANGE / BRIDE DU MOTEUR / FLANGIA MOTORE / BRIDA DEL MOTOR
		903	945333 00000	945331-00000	INNENSECHSKANTSCHRAUBE - M8x35 / HEX HEAD SCREW / VIS ALLEN / VITE ESAGONALE INTERNA / TORNILLO HEXAGONAL INTERIOR
		906	902100 54200	902100-54100	KUPPLUNGSNABE / COUPLING / ACCOUPLEMENT / GIUNTO / MITAD DE ACOPLAMIENTO

²⁾ variantenabhängige Bauteile / variant-dependent components / composants variante-dependantes / componenti variante-dispendenti / componentes variante-dependientes